

\$2.00

# *ham* **radio**

*magazine*

*hr* 

**SEPTEMBER 1980**

- L matching network 26
- half-wave baluns 32
- quads and quagis 37
- pi-network design 50
- TS-520-SE counter mixer 60

## **GUNN OSCILLATOR DESIGN FOR THE 10-GHZ BAND**

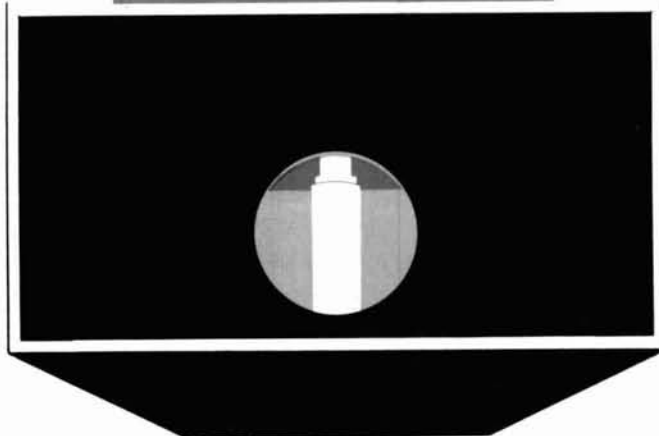

# tempo...

## the first in synthesized portables gives you the broadest choice at the lowest price

### ...the new S-5

- \* The only synthesized hand-held offering 5 watts output. (Switchable for 1 or 5 watt operation)
- \* The same dependability as the time proven S-1. Circuitry that has been proven in more than a million hours of operation.
- \* Heavy duty battery pack.
- \* External microphone capability.
- \* The S-5's exciting low price...only \$299.00
- \* With touch tone pad \$339.00

#### SPECIFICATIONS

Frequency Coverage: 144 to 148 MHz  
 Channel Spacing: Receive every 5 kHz, transmit Simplex or  $\pm$  600 kHz  
 Power Requirements: 9.6 VDC  
 Current Drain: 17 ma-standby, 900 ma-transmit  
 Antenna Impedance: 50 ohms  
 Dimensions: 40 mm x 62 mm x 170 mm (1.6" x 2.5" x 6.7")  
 Weight: 17 oz.  
 Sensitivity: Better than .5 microvolts nominal for 20 db

#### SUPPLIED ACCESSORIES

Telescoping whip antenna, ni-cad battery pack, charger.

#### OPTIONAL ACCESSORIES

12 Button touch tone pad (not installed): \$39 • 16 Button touch tone pad (not installed): \$48 • Tone burst generator: \$29.95 • CTCSS sub-audible tone control: \$29.95 • Rubber flex antenna: \$8 • Leather holster: \$16 • Cigarette lighter plug mobile charging unit: \$6 • Matching 30 watt output 13.8 VDC power amplifier (S30): \$89 • Matching 80 watt output power amplifier (S80): \$149

### The Tempo S-2

Tempo is first again. This time with a superior quality synthesized 220 MHz hand held transceiver. With an S-2 in your car or pocket you can use 220 MHz repeaters throughout the U.S. It offers all the advanced engineering, premium quality components and exciting features of the S-1. The S-2 offers 1000 channels in an extremely lightweight but rugged case.

If you're not on 220 this is the perfect way to get started. With the addition of the S-25 (25W output) or S-75 (75W output) Tempo solid state amplifier it becomes a powerful mobile or base station. If you have a 220 MHz rig, the S-2 will add tremendous versatility. Its low price includes an external microphone capability, heavy duty ni-cad battery pack, charger, and telescoping whip antenna.  
 Price...\$349.00 With touch tone pad...\$399.00

#### TEMPO VHF & UHF SOLID STATE POWER AMPLIFIERS

Boost your signal... give it the range and clarity of a high powered base station. VHF (135 to 175 MHz)

Drive Power	Output	Model No.	Price
2W	130W	130A02	\$209
10W	130W	130A10	\$189
30W	130W	130A30	\$199
2W	80W	80A02	\$169
10W	80W	80A10	\$149
30W	80W	80A30	\$159
2W	50W	50A02	\$129
2W	30W	30A02	\$ 89

UHF (400 to 512 MHz) models, lower power and FCC type accepted models also available.

TOLL FREE ORDER NUMBER: (800) 421-6631

For all states except California.  
 Calif. residents please call collect on our regular numbers.

11240 W. Olympic Blvd., Los Angeles, Calif. 90064 213/477-6701  
 931 N. Euclid, Anaheim, Calif. 92801 714/772-9200  
 Butler, Missouri 64730 816/679-3127

# Henry Radio

Prices subject to change without notice.



Shown with optional touch tone pad

### The new improved Tempo S-1

- The first and most thoroughly field tested hand-held synthesized radio available. 800 channels in the palm of your hand.
- Simple to operate. (You don't need a degree in computer programming)
- Heavy duty battery pack allows more operating time between charges.
- External microphone capability
- The lowest price ever...\$259.00
- The S-1T (With touch tone pad installed)...\$289.00

Now available is the expanded line of Tempo commercial hand holds... "big name" quality at affordable prices. The FMH-12 & FMH-15 operate in the 135 to 174 MHz range and the FMH-40 & FMH-44 in the 440 to 480 MHz range. Tempo also offers the FMT-2 & FMT-42. They provide excellent VHF or UHF mobile communications and feature a remote control head for hide-away mounting. Also available is the superb MR-3 pocket receiver... a miniature, 2 channel VHF high band monitor or paging receiver.

Please call or write for complete information. Also available from Tempo dealers throughout the U.S. and abroad.



# IT'S ONLY ASTRO-LOGICAL... THE CHANGE FROM SWAN TO CUBIC!

**102BXA — \$1195.00**

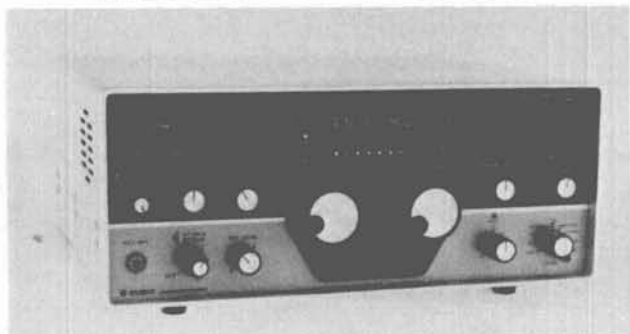

Dual PTO's, 235 Watts PEP & CW on all Frequencies, IF Passband Tuning, with LED Position Indicators and Full Break-In

**150A — \$925.00**

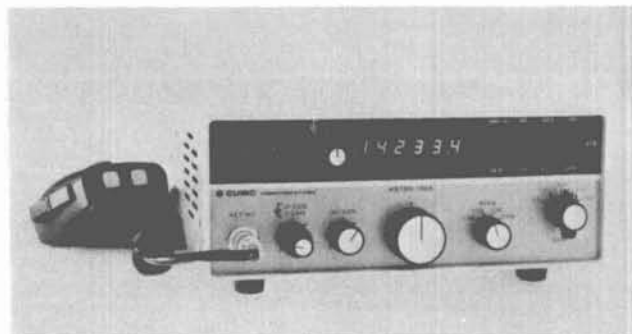

HF SSB Transceiver Featuring "VRS™" a Knob with a New Twist, and Over 100,000 Fully Microprocessor-Controlled Frequencies on Present or Envisioned "Ham" Bands.

There's a new name on two popular Amateur transceivers. CUBIC COMMUNICATIONS replaces SWAN on the front panel of both the ASTRO 102BXA and the ASTRO 150A. Swan Electronics actually has been part of the Cubic Corporation for years. With Cubic being a large, highly diversified, multi-million-dollar company, known and respected worldwide, this change seemed only logical.

The same people will be making these radios in the very same factory. You're assured of continued superb performance. Performance that has made both ASTRO models outstanding choices for today's demanding Amateur.

Prices remain unchanged. However, the ASTRO 102BXA will be supplied less the old, marginal, CWN crystal filter. A superior, 400 Hz, 6-pole CWN filter, to operate with the passband tuning, is optional, priced at \$82.50 list.

Shipment of the new CUBIC COMMUNICATIONS ASTRO transceiver line has already begun.

It's time to start thinking of AMERICAN PRODUCTS for AMERICAN HAMS. If we're to remain the strong and proud America we all love and respect, we've got to start looking for ways to keep our hard-earned dollars at home.

MADISON ELECTRONIC SUPPLY, INC., is proud to lead the way in the 1980s with these two fine examples of AMERICAN technology.

*ACCESSORIES AVAILABLE  
SEND FOR COMPLETE BROCHURE  
CALL FOR QUOTES*

# MADISON

**Electronics Supply, Inc.**

1508 McKinney • Houston, Texas 77002 • 713/658-0268

# NEW! MFJ INTRODUCES THE GRANDMASTER MEMORY KEYERS

At \$139.95 this MFJ-484 GRANDMASTER memory keyer gives you more features per dollar than any other memory keyer available — and Here's Why . . .

**WEIGHT CONTROL** TO PENETRATE ORM. **PULL** TO COMBINE MEMORIES A AND B FOR 1, 2, OR 3 FIFTY CHARACTER MESSAGES.

**MESSAGE BUTTONS** SELECT DESIRED 25 CHARACTER MESSAGES.

**RESETS MEMORY** IN USE TO BEGINNING.

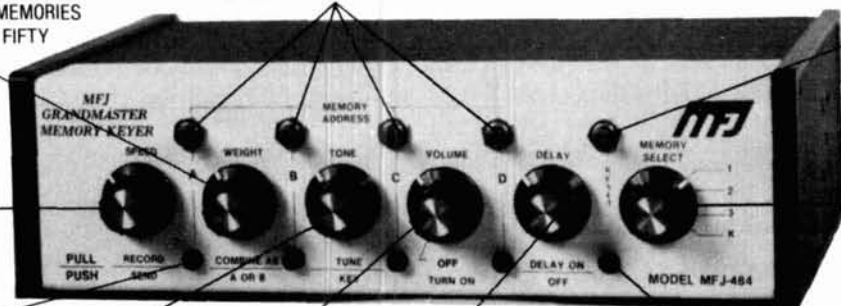

**SPEED CONTROL**, 8 TO 50 WPM. **PULL** TO RECORD.

**LEDs (4)** SHOW WHICH MEMORY IS IN USE AND WHEN IT ENDS.

**TONE CONTROL**. **PULL** TO TUNE.

**VOLUME CONTROL**. **POWER ON-OFF**.

**DELAY REPEAT CONTROL** (0 TO 2 MINUTES). **PULL** FOR AUTO REPEAT.

**LED INDICATES** DELAY REPEAT MODE.

**MEMORY SELECT**: POSITIONS 1, 2, 3 ARE EACH SPLIT INTO MEMORY SECTIONS A, B, C, D (UP TO TWELVE 25 CHARACTER MESSAGES). SWITCH COMBINES A AND B. **POSITION K** GIVES YOU 100, 75, 50, OR 25 CHARACTERS BY PRESSING BUTTONS A, B, C, OR D.

**NOW YOU CAN CALL CQ, SEND YOUR QTH, NAME, ETC., ALL AUTOMATICALLY.**

And only MFJ offers you the MFJ-484 Grandmaster memory keyer with this much flexibility at this price.

Up to twelve 25 character messages plus a 100, 75, 50, or 25 character message (4096 bits total).

A switch combines 25 character messages for up to three 50 character messages.

To record, pull out the speed control, touch a message button and send. To playback, push in the speed control, select your message and touch the button. That's all there is to it!

You can repeat any message continuously and even leave a pause between repeats (up to 2 minutes). Example: Call CQ. Pause. Listen. If no answer, it repeats CQ again. To answer simply start sending. LED indicates Delay Repeat Mode.

Instantly insert or make changes in any playing message by simply sending. Continue by touching another button.

Memory resets to beginning with button, or by tapping paddle when playing. Touching message button restarts message.

LEDs show which 25 character memory is in use and when it ends.

Built-in memory saver. Uses 9 volt battery, no drain when power is on. Saves messages in memory when power loss occurs or when transporting keyer. Ultra compact, 8x2x6 inches. All IC's in sockets.

PLUS A MFJ DELUXE FULL FEATURE KEYER. Iambic operation with squeeze key. Dot-dash insertion.

Dot-dash memories, self-completing dots and dashes, jamproof spacing, instant start (except when recording).

All controls are on front panel: speed, weight, tone, volume. Smooth linear speed

control. 8 to 50 WPM.

Weight control lets you adjust dot-dash-space ratio; makes your signal distinctive to penetrate ORM.

Tone control. Room filling volume. Speaker.

Tune function keys transmitter for tuning. Ultra reliable solid state keying: grid block, cathode, solid state transmitters (-300 V, 10 ma. max., +300 V, 100 ma. max.). CMOS ICs, MOS memories. Use 12 to 15 VDC or 110 VAC with optional AC adapter, \$7.95. Automatically switches to external batteries when AC power is lost.

OPTIONAL BENCHER IAMBIC PADDLE for all memory keyers. Dot and dash paddles have fully adjustable tension and spacing for the exact "feel" you like. Heavy base with non-slip rubber feet eliminates "walking". \$39.95 plus \$3.00 for shipping and handling.



THIS MFJ-482 FEATURES FOUR 25 OR A 50 AND TWO 25 CHARACTER MESSAGES.

- Speed, volume, weight, tone controls
- Combine memory switch
- Repeat, tune functions
- Built-in memory saver

\$99<sup>95</sup>



Similar to MFJ-484 but with 1024 bits of memory, less delay repeat, single memory operating LED. Weight and tone controls adjustable from rear panel. 6x2x6 inches. 110 VAC or 12 to 15 VDC.

THIS MFJ-481 GIVES YOU TWO 50 CHARACTER MESSAGES.

- Speed, volume, tone controls
- Repeat function
- Tune function
- Built-in memory saver

\$79<sup>95</sup>



Similar to MFJ-482 but with two 50 character messages, less weight controls. Internal tone control. Volume control is adjustable from rear panel. 5x2x6 inches. 110 VAC or 12 to 15 VDC.

For Orders Call toll-free **800-647-1800**

Order any product from MFJ and try it. If not delighted, return within 30 days for a prompt refund (less shipping).

Order today. Money back if not delighted. One year unconditional guarantee. Add \$3.00 shipping/handling.

For technical information, order/repair status, in Mississippi, outside continental USA, call 601-323-5869.

Order By Mail or Call TOLL FREE 800-647-1800 and Charge It on



**MFJ ENTERPRISES, INC.**

P. O. BOX 494  
MISSISSIPPI STATE, MISSISSIPPI 39762

# ham radio

magazine

SEPTEMBER 1980

volume 13, number 9

**T. H. Tenney, Jr., W1NLB**  
publisher and  
acting editor

**editorial staff**

Martin Hanft, WB1CHQ  
administrative editor

Robert Schneider, N6MR  
assistant editor

Alfred Wilson, W6NIF  
technical editor

Thomas F. McMullen, Jr., W1SL  
Joseph J. Schroeder, W9JLV  
Leonard H. Anderson  
associate editors

W. E. Scarborough, Jr., KA1DXQ  
graphic production manager

Catherine M. Umphress  
production assistant

Wayne Pierce, K3SUK  
cover

**publishing staff**

Peter M. Hurd, N1SS  
assistant publisher

J. Craig Clark, Jr., N1ACH  
advertising manager

Susan Shorrock  
circulation manager

**ham radio magazine**  
is published monthly by  
Communications Technology, Inc  
Greenville, New Hampshire 03048  
Telephone: 603-878-1441

**subscription rates**

United States: one year, \$15.00  
two years, \$26.00; three years, \$35.00

Canada and other countries (via Surface Mail)  
one year, \$18.00; two years, \$32.00  
three years, \$44.00

Europe, Japan, Africa (via Air  
Forwarding Service) one year, \$25.00

All subscription orders payable in  
United States funds, please

**foreign subscription agents**

Foreign subscription agents are  
listed on page 83

Microfilm copies  
are available from  
University Microfilms, International  
Ann Arbor, Michigan 48106  
Order publication number 3076

Cassette tapes of selected articles  
from *ham radio* are available to the  
blind and physically handicapped  
from Recorded Periodicals  
919 Walnut Street, 8th Floor  
Philadelphia, Pennsylvania 19107

Copyright 1980 by  
Communications Technology, Inc  
Title registered at U.S. Patent Office

Second-class postage  
paid at Greenville, N.H. 03048  
and at additional mailing offices  
ISSN 0148-5989

Postmaster send Form 3579 to *ham radio*  
Greenville, New Hampshire 03048



## contents

**12 Gunn oscillator design  
for the 10-GHz band**

Richard Bitzer, WB2ZKW

**24 measuring capacitance  
of electrolytic capacitors**

Jerome H. Hemmye, KP4DIF

**26 appreciating the L  
matching network**

Ernest A. Franke, WA2EWT

**32 half-wave balun:  
theory and application**

John J. Nagle, K4KJ

**37 Yagi antenna design:  
quads and quagis**

James L. Lawson, W2PV

**46 navigational aids  
for small-boat operators**

Henry S. Keen, W5TRS

**50 optimum pi-network design**

Ulrich Fleischmann, DL9LX

**58 regulated power supply  
for VHF transceivers**

Lawrence F. Beebe, WA8RXU

**60 counter mixer for the  
Kenwood TS-520-SE transceiver**

E. R. Lamprecht, W5NPD

**64 a simple 40-meter transceiver**

Edmund H. Marriner, W6XM

**94 advertisers index**

**83 flea market**

**88 ham mart**

**68 ham notebook**

**6 letters**

**74 new products**

**4 observations and  
comments**

**8 presstop**

**94 reader service**

**67 short circuits**



# Observations & Comments

While browsing through RSGB's *Radio Communications* (August, 1979, page 751) I came across an interesting letter from H. Herzer, DL7DO,\* which had been subsequently picked up by *QST* in their July, 1980, issue (page 73). The subject of Herr Herzer's letter was the antiquated RST signal-reporting system and what might be done about it.

Herr Herzer presents a pretty good case for eliminating the RST system in terms of today's standards of equipment sophistication, band conditions, and operating methods.

During the early years of Amateur Radio, as Herzer points out, the RST reporting system was a valuable aid to operators, as most (if not all) equipment was homemade. Amplitude levels were low, power-supply filter systems were primitive or nonexistent, and measurement equipment was crude. So the RST system was a means of evaluating on-the-air signals. If your rig used, say, a type 45 tube with 90 volts on the plate, a report of S7 meant that the signal was "fairly strong." A tone report of T8 meant that something had to be done in the power-supply filter department to bring the signal to T9: "pure dc note." If you received a readability report of R3, this could mean just about anything, from poor propagation conditions to faulty adjustment of receiving equipment at the other end of the circuit.

Herzer recommends a "Q System" to replace the antiquated RST reporting system for both CW and radiotelephone communications. In Herzer's system "Q" stands for *transmission quality*, which accounts for the one and only parameter relevant to successful information transfer by Amateur Radio stations. It all boils down to: "Has the message been received and understood?" The Q reporting system used only three variables:

- Q1 At no time has there been sufficient transmission quality; that is, no copy has been received.*
- Q2 Sufficient transmission quality has occurred some of the time; that is, partial copy has been received.*
- Q3 Sufficient transmission quality has occurred at all times; that is, full copy has been received.*

Intermediate stages of reporting, such as Q1/2 or Q2/3, might be used. You can always ask the other operator for an explanation.

Herzer feels that such a system will result in a considerable reduction in QRM, contest reporting, and logging. I agree. Today's RST reporting system is not only redundant but meaningless.

Of course, this means changing your QSL cards to show the new system, and it will probably take a long time to implement on a worldwide basis. But the system has real merit in reducing "on-the-air" pollution in today's Amateur bands.

The other night I worked several stations, foreign and domestic, on the low end of the 14-MHz CW band. All reports were RST 579. During contest operation, all stations reported RST 599. Utterly meaningless! Why bother with such a signal-reporting system? In fact, why is any signal-reporting system useful today?

What do you think? We'd like your opinion.

**Alf Wilson, W6NIF**  
technical editor

\**Radio Communications*, Journal of the Radio Society of Great Britain, August, 1979, page 751.

# EITHER WAY YOU GO...2 OR 6!



**GO WITH QUALITY.  
GO WITH ICOM.  
GO WITH THE BEST.**

The IC-251A is the newest addition to ICOM's all mode transceiver line. Like the matching IC-551, the IC-251A has dual digital VFO's, three memories, scanning (even SSB), and many other features you only get from ICOM.

Both units include the no backlash, no delay light chopper, similar to the IC-701, as a standard feature at no cost. Coupled to the microprocessor, this provides split frequency operation as well as completely variable offsets.

Check the specs, and you'll agree, either way you go, ICOM is simply the best.

#### SPECIFICATIONS

Listed below are some of the

IC-551 specifications. IC-251A's specs are identical except where noted (in bold).

**Frequency Coverage:** 50~54MHz  
(143.8~148.19MHz)

#### RF Output Power:

SSB 10W PEP  
(1~10W adjustable) (10W)  
CW 10W  
(1~10W adjustable) (10W)  
AM 4W  
(0~4W adjustable) ( — )  
FM\* 10  
(1~10W adjustable) (1~10W)

#### Sensitivity:

SSB/CW/AM  
Less than 0.5µV for 10dB S+N/N  
FM\* More than 30dB  
S+N+D/N+D at 1µV

**Squelch Sensitivity:** SSB/CW/AM  
1µV  
FM\* 0.4µV (0.4µV)

#### Selectivity:

SSB/CW/AM  
More than ±1.1KHz at -6dB (1.2)  
Less than ±2.2KHz at -6dB (2.4)  
(When Pass Band Tuning Unit is installed: less than 1KHz at -6dB)  
FM\* More than ±7.5KHz at -6dB  
Less than ±15KHz at -60dB

**Dimensions:** 111mm (H)  
× 241mm (W) × 311mm (D)

**Weight:** 6.1kg (5kg)

**Spurious Response Rejection Ratio:**  
More than 60dB

HF/VHF/UHF AMATEUR AND MARINE COMMUNICATION EQUIPMENT



# ICOM

## ICOM AMERICA, INCORPORATED

Sales Service Centers located at:

2112 116th Avenue NE  
Bellevue, WA 98004  
Phone (206) 454-8155

3331 Towerwood Dr., Suite 307  
Dallas, TX 75234  
Phone (214) 620-2780

#### ICOM INFORMATION SERVICE

2112 116th Ave., N.E.  
Bellevue, WA 98004

Please send me:  IC-551 specifications sheet;  IC-251A specifications sheet;  List of Authorized ICOM Dealers.

NAME \_\_\_\_\_ CALL \_\_\_\_\_

ADDRESS \_\_\_\_\_

CITY \_\_\_\_\_ STATE \_\_\_\_\_ ZIP \_\_\_\_\_

You may send a machine copy of this form

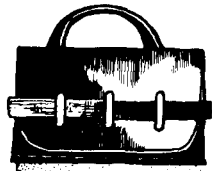

## comments

### microphones

Dear HR:

Readers should be cautioned to avoid using the type of audio cables suggested by W1OLP in his article on microphones and speech processing in the March issue of *ham radio*. Only the audio line should be inside the shield. Having the audio line plus the PTT line and/or battery line inside the shield will, in many cases, result in unwanted noises in the transmitted audio: hum, switching noises, and stray rf. It is preferable to use microphone cable which has one shielded line for audio, with the PTT and other control lines outside the shield.

**Buddy Massa, W5VSR**  
New Orleans, Louisiana

### Hallicrafters story

Dear HR:

The fine story by W6SAI about Bill Halligan's HT-4 (BC-610) in the November, 1979, issue of *ham radio* surely brought back a flood of memories — Utah Beach, Ste. Mere Eglise, Carentan, Isigny.

We had five mobile units in ADSEC (Advanced Section Communications Zone), 3rd Army, and only one of them was an SCR-299, the others were SCR-399s. I would like to call your attention to the incorrect caption with the photograph on page 24. The mobile unit is an SCR-299, not 399; the 399 differed mainly from the 299 in that it was not housed in a panel truck; it was provided with an

HO-17 plywood shelter, designed to fit the equally famous 6x6 International truck. The shelter could be lifted off, complete with its equipment, and operated on the ground as a fixed station.

Our first team's unit was installed in a "Duck" amphibious version of the 6x6, with two little PE-75 gas generators connected in parallel on the aft deck. They were let down from the LST *before* H-hour on D-day and made an attempt to scramble ashore, but they were met by severe mortar fire and forced to withdraw. Later they gained an exposed position on the beach and made contact with our station in England that had been set up in late May.

I was the Platoon Sergeant of the fifth team and some days later we had all units dispersed several miles apart and well camouflaged in the Normandy apple orchards. They were tied with field wire keying lines (duplexed for telephone) to a radio center in the loft of an old French barn. In the stable below were the TC-10 telephone boards and the Message Center. All operation was manual and long press dispatches were cleared between items of military traffic. Later three more SCR-399s arrived and eight were operated for a few days. Then one-by-one the ADSEC units began to leave to follow the action. Some months later one was in Namur, Belgium, in contact with besieged Bastogne.

I should add that the operators who accompanied these units were highly specialized, having worked in the signal center at the Pentagon before leaving the States. Likewise, many of the technicians were specially trained on SSB multi-channel (AFSK) high-power transmitters (40 kW). They formed the nucleus of the Paris communications center in the "Block House" about a block from the Arc de Triomphe de L'Etoile on

Rue Wagram. Some followed the action; some had very important missions elsewhere.

We experienced only one real trouble with our BC-610Es. The high-voltage in the modulation transformer would break down to ground, killing the rig. We found that we could set the transformer up on four short standoff insulators supplied in the spares chest and be back on the air in half an hour. Information was sent up through channels on this fix and apparently others had experienced a similar failure because a Field Change Bulletin was put out by the Signal Corps directing that this modification be installed in all BC-610Es.

After VE-day, returning to France and to the Signal Depot at Mohn near Meziers, SCR-399s were stashed in the fields around the buildings as if we were operating a trailer park. I wonder now what happened to all of them. Some were trans-shipped to the Pacific Theater, but most were left behind.

**Clifford O. Field, WA2JVD**  
Fair Haven, New York

### more Hellschreiber

Dear HR:

E.H. Conklin, K6KA, is not quite right in describing the Hellschreiber as a wideband system (Comment, March, 1980). Admittedly, the bandwidth of any keyed system is a function of the keyed element rise time, but with proper pulse shaping as practiced by the majority of the PA0 and German Amateurs the amount of spectrum space occupied by a Hellschreiber signal is only marginally greater than that of 45.5-baud RTTY.

The bandwidth necessary for Hellschreiber may be quite easily computed by reference to CCIR Recommendations, which in Appendix 5 of Radio Regulations state that this is

*(Continued on Page 66)*



# WHEN OUR CUSTOMERS TALK... WE LISTEN.



John Fail, KL7GRF/6  
Long Beach, CA



Vernelle "Red" Irwin, K9KUW  
Kenney, IL



Harry Belock, AA2X  
Great Neck, NY



Tom Gentry, K5VOU  
Dallas, TX



John Whitaker, W5HEZ  
Baton Rouge, LA

## And we respond with unexcelled RTTY equipment.

One reason RTTY equipment designed by HAL is always state-of-the-art quality is our open channel of communications with customers.

We want to hear the "What if's..." and "How about's..." that come from active and dedicated RTTY operators. Our engineers have combined

customer ideas with their own to create the most advanced equipment features and capabilities in the industry.

It adds up to greater enjoyment of RTTY operation and a dependability factor backed with a full one-year warranty.

**Write or give us a call. We'll be glad to send you our new RTTY catalog.**

### HAL COMMUNICATIONS CORP.

Box 365  
Urbana, Illinois 61801  
217-367-7373

For our European Customers Contact:  
Richter & Co., D3000 Hannover 1  
Transradio, S.A., 6816 Bissone/Lugano

# presstop

FREEDOM TO LISTEN TO RADIO communications would be drastically curtailed by a bill introduced in the House of Representatives. HR-7747, by Rep. Richard Preyer (D-North Carolina) and several co-sponsors, would "prohibit the unauthorized reception of private radio communications." By prohibiting reception this new bill goes much further than Section 605 of the Communications Act, which is generally interpreted to ban the divulging of the content of private radio communications.

Pressure To Ban Reception of various radio services has been around for a long time, most recently in connection with radar speed monitor detectors. Now pressure is coming from satellite TV distributors, worried that do-it-yourselfers will cut into their revenues.

HR-7747 Has Been Referred to the House Committee on Interstate and Foreign Commerce and Judiciary for further action.

FCC'S AMATEUR EXAM PASS RATE has been climbing steadily in recent months, after having remained fairly constant for years, an FCC analysis of Field Office reports shows. Recently available study materials containing exact exam questions and answers is the only apparent reason for the shift, which is the cause of concern in both FCC and Amateur circles. There is considerable feeling that the increased pass rates are due mainly to memorization rather than understanding, which would result in unqualified applicants receiving Amateur licenses and the license itself being cheapened as a result.

The New Exams That Came into use in June should at least temporarily curb the problem. If, however, the West Coast publisher who's been selling the question-and-answer sheets gets the new exams, a considerable investment of time and taxpayers' money will have gone for naught. The FCC's rules apparently have no provisions for protecting the security of its examinations.

PETE HURD, K4NSS/N1SS, HAS JOINED HAM RADIO as assistant publisher. Pete, who's long been involved with many activities that concern Amateur Radio's future, arrived in Greenville on July 14 to begin his new role on a commuting basis. As assistant publisher he'll be responsible for day-to-day management of the Ham Radio Publishing Group and its three publications.

Pete's Part In The ACAR operation, where he served as the executive secretary for the Advisory Committee for Amateur Radio that so successfully formulated the strong pro-Amateur Radio U.S. WARC position, has made him well known to high-ranking Amateurs both domestically and abroad. Professionally, Pete served with the Air Force until his retirement a year ago, where he was a Colonel with the Department of Defense working in research and engineering management. There he not only worked closely with the U.S. electronics industry, but was often in Europe on NATO business where he became well known to many overseas Amateurs.

AN AMATEUR EQUIPMENT RIPOFF in the Washington, D.C., area has also victimized some dealers in other areas as well. Using the expired call W5SRZ as part of his "identification" and sometimes on the air as well, an individual from northern Virginia has been able to purchase quite a bit of equipment without paying for it.

He Orders By Telephone, using a valid credit card number not his own. Since Master Charge's credit OK is only for the number and not who or where the card user actually is, the sale is OKed and the merchandise delivered without hesitation when the buyer comes in to pick it up.

Distributors In California, Florida, and New York, as well as several in the greater Washington area are known to have fallen victim to "W5SRZ," who also sometimes says he's an airline captain. Although some criminal charges have been filed against him, he's apparently still active.

Merchants Who Accept Credit card orders by phone or mail must be especially cautious, as the law makes them the losers, with little recourse, when an incorrect account is billed. One dealer first learned he'd been taken when a woman phoned to ask why he'd put \$1500 in radio equipment on her charge card!

U.S. AMATEUR POPULATION SWELLED to 385,625 licensees at the end of June, an increase of 1,837 from the start of the month. FCC statistics went on to show that Amateur Radio experienced twice as much growth (12,583 new licenses issued) in the first six months of this year as it did in all of 1979 (6,119 new licenses). June's increase, in fact, nearly equaled the 2,401 licenses issued between April and December of last year!

INDECENT LANGUAGE COST WD8NLS his station license and triggered suspension of his General Class operators license for the remainder of its term. FCC engineers had monitored his use of indecent language on the air on three different occasions, plus his rebroadcasting music on another.

# SUPER RIG



## NEW TEN-TEC

## OMNI-C 9 Band Transceiver + HERCULES Solid-State kW Linear

**TEN-TEC SUPER RIG IS READY.** For every band, every band condition. With the latest in solid-state hf technology, the latest in features. To make communications easier, more reliable — super.

### OMNI-C

The new model in this famous series. With new coverage and new features to make it better than ever!

**All 9 HF Bands.** From 160 through 10 meters, including the new 10, 18 and 24.5 MHz bands. Coverage you can live with—for years and years.

**3-Mode, 2-Range Offset Tuning.** Offset the receiver section or the transmitter section or the entire transceiver! In 2 ranges:  $\pm 500$  Hz or  $\pm 4$  kHz. For complete flexibility in fine tuning, a DX work, or net operations.

**Seven Response Curves.** Four for SSB, three for CW. With new switching to select the standard 2.4 kHz filter, optional 1.8 kHz SSB filter, 500 Hz or 250 Hz CW filters, and standard 450 and 150 Hz CW active audio filters. Up to 16 poles of i-f filtering plus audio filtering to handle any situation.

**Built-In Notch Filter and Noise Blanker.** Notch is variable from 200 Hz to 3.5 kHz with a depth of more than 50 dB. New noise blanker reduces ignition and line noise. Both standard equipment.

**"Hang" AGC.** New, smoother operation.

**Super Specs.** Optimized sensitivity—a balance between dynamic range and sensitivity ( $2 \mu\text{V}$  on 160 to  $0.3 \mu\text{V}$  on 10 meters) Greater dynamic range: better than 90 dB. And a PIN diode switchable 18 dB attenuator. 200 watts input on all bands! 100% duty cycle on all bands for up to 20 minutes.

**Super Convenient.** Built-In VOX with 3 up-front controls. Built-In PTT control at front and rear jacks. Built-In Zero-Beat switch puts you on exact frequency. Built-In Adjustable Sidetone with variable pitch and level. Adjustable ALC for full control from low power to full output. 2-Speed Break-In, fast or slow speeds to fit operating conditions. Built-In Speaker eliminates desk clutter. Automatic Sideband Selection—reversible.

**Super Design.** All Solid-State and Broadbanded—from the pioneer, Ten-Tec. Modular plug-in circuit boards. Functional Styling with convenient controls, full shielding, easy-to-use size ( $5\frac{3}{4}''\text{h} \times 14\frac{1}{4}''\text{w} \times 14''\text{d}$ ).

**Super Hercules Companion.** Styled to match, plus separate receiving antenna capability, plus transceiver front panel control of linear's bandswitching (one knob does it all).

**Full Accessory Line** including filters, remote VFO, power supplies, keys, microphones, speech processors, antenna tuners—all in matching color.

Model 546 OMNI-Series C.... \$1189.

### HERCULES

Amateur Radio's first full break-in solid-state kW linear amplifier. With the reliability you'd expect from the pioneer in high-power solid-state technology—TEN-TEC.

**All Solid-State.** No tubes. Instead, HERCULES uses two 500-watt push-pull solid-state amplifier modules with an output combiner. Super solid.

**Broadband Design.** No knobs, no tuning. From the pioneer, TEN-TEC. For fast, effortless changing of bands. Super easy.

**Automatic Bandswitching** when used with OMNI (the OMNI bandswitch also controls HERCULES bandswitching through a motor driven stepping switch). Super convenient.

**Full Break-In.** HERCULES puts the conversation back into high power CW operation—you can hear between every character you send.

**Full Coverage.** 160 through 15 meters plus four "AUX" positions for 10-meter conversion by owner and future band additions.

**Full Gallon.** 1000 watts input on all bands, 600 watts output, typical. Built-in forced-air cooling. Driving power: 50 watts, typical. Adjustable negative ALC voltage. 100% duty cycle for SSB voice modulation; 50% duty cycle for CW/RTTY (keydown time: 5 minutes max.) Continuous carrier operation at reduced output.

**Full Protection.** Six LED status indicators continuously monitor operating conditions and shut down the amplifier whenever any one exceeds set limits (the exciter automatically bypasses the amplifier under amplifier shut-down for barefoot operation). The six parameters monitored are: 1) overdrive; 2) improper control switch setting; 3) heat sink temp.; 4) SWR; 5) overvoltage/overcurrent; 6) rf output balance. Two meters monitor collector current, voltage, and forward/reverse power. And a highly efficient automatic line voltage correction circuit (patent applied for) eliminates the need for selecting transformer taps, prevents applying too high a voltage to final amplifier devices, becomes operative under low line conditions.

**Super Power Supply.** Provides approximately 45 VDC @ 24 amperes, operates on 105/125 VAC or 210/250 VAC. Tape wound transformer and choke reduce weight (50 lbs.) and size ( $7\frac{1}{2}''\text{h} \times 15\frac{3}{4}''\text{w} \times 13\frac{1}{2}''\text{d}$ ). Separate enclosure.

**Super Styling.** Designed to match OMNI, the HERCULES has the same height as OMNI, plus matching ball and matching colors. The front panel is simplicity in itself with two push-button switches (power and mode) plus two knobs (meter and bandswitch), and a "black-out" monitor panel (when unit is off, meters are unobtrusive). Amplifier size is  $5\frac{3}{4}''\text{h} \times 16''\text{w} \times 15\frac{1}{2}''\text{d}$ .

Model 444, HERCULES amplifier & power supply.... \$1575.

Experience SUPER RIG at your TEN-TEC dealer, or write for full details.

**TEN-TEC, INC.**  
SEVIERVILLE, TENNESSEE 37862  
EXPORT 3715 LINCOLN AVE., CHICAGO, ILL. 60646

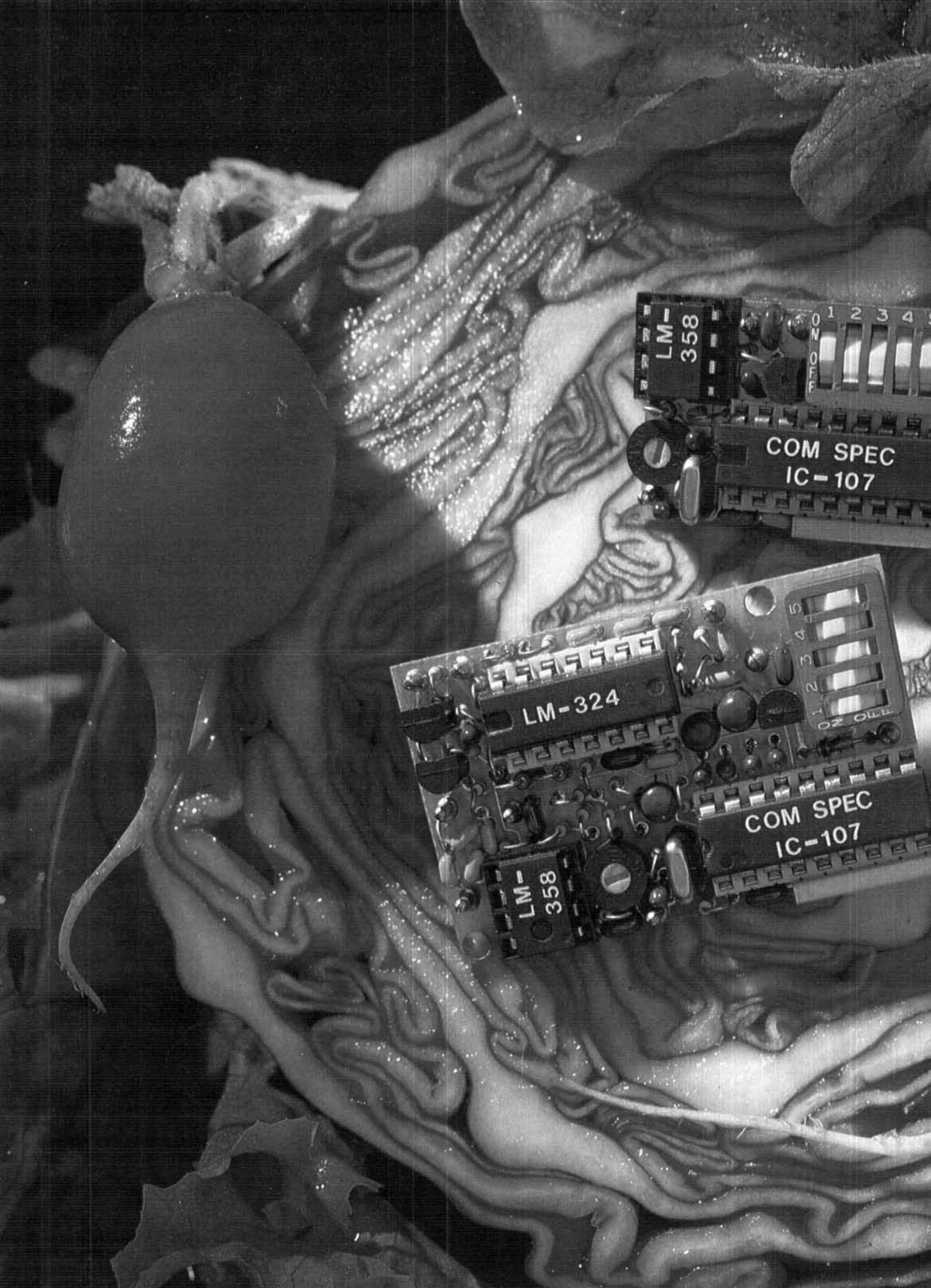

LM-358

COM SPEC  
IC-107

LM-324

COM SPEC  
IC-107

# A fresh idea!

Our new crop of tone equipment is the freshest thing growing in the encoder/decoder field today. All tones are instantly programmable by setting a dip switch; no counter is required. Frequency accuracy is an astonishing  $\pm .1$  Hz over all temperature extremes. Multiple tone frequency operation is a snap since the dip switch may be removed. Our SS-32 encode only model is programmed for all 32 CTCSS tones or all test tones, touch-tones and burst-tones.

And, of course, there's no need to mention our 1 day delivery and 1 year warranty.



## TS-32 Encoder-Decoder

- Size: 1.25" x 2.0" x .40"
- High-pass tone filter included that may be muted
- Meets all new RS-220-A specifications
- Available in all 32 EIA standard CTCSS tones

## SS-32 Encoder

- Size: .9" x 1.3" x .40"
- Available with either Group A or Group B tones

## Frequencies Available:

Group A			
67.0 XZ	91.5 ZZ	118.8 2B	156.7 5A
71.9 XA	94.8 ZA	123.0 3Z	162.2 5B
74.4 WA	97.4 ZB	127.3 3A	167.9 6Z
77.0 XB	100.0 1Z	131.8 3B	173.8 6A
79.7 SP	103.5 1A	136.5 4Z	179.9 6B
82.5 YZ	107.2 1B	141.3 4A	186.2 7Z
85.4 YA	110.9 2Z	146.2 4B	192.8 7A
88.5 YB	114.8 2A	151.4 5Z	203.5 M1

- Frequency accuracy,  $\pm .1$  Hz maximum -  $40^{\circ}\text{C}$  to  $+85^{\circ}\text{C}$
- Frequencies to 250 Hz available on special order
- Continuous tone

Group B						
TEST-TONES:	TOUCH-TONES:	BURST-TONES:				
600	697 1209	1600	1850	2150	2400	
1000	770 1336	1650	1900	2200	2450	
1500	852 1477	1700	1950	2250	2500	
2175	941 1633	1750	2000	2300	2550	
2805		1800	2100	2350		

- Frequency accuracy,  $\pm 1$  Hz maximum -  $40^{\circ}\text{C}$  to  $+85^{\circ}\text{C}$
- Tone length approximately 300 ms. May be lengthened, shortened or eliminated by changing value of resistor

Wired and tested: TS-32 \$59.95, SS-32 \$29.95

 **COMMUNICATIONS SPECIALISTS**

426 West Taft Avenue, Orange, California 92667  
(800) 854-0547 / California: (714) 998-3021



# Gunn oscillator design

## for the 10-GHz band

Gunn oscillators are an attractive alternative to reflex klystrons as a signal source in the Amateur microwave bands. However, to some, the design of stable Gunn oscillators is considered to be somewhat empirical. In practice a particular design approach is tried then perfected through cut-and-try. Much research has been done with Gunn devices as described in the literature,<sup>1,2</sup> leading to high-quality commercial units.

In an effort to dispel some of the mystery surrounding Gunn oscillator design, I'll set down some ground rules for a certain design approach that produced good results. I wish to emphasize at this point that what follows is only *one* of several approaches that will give results. The oscillators were designed for 10 GHz, but this design could be used and modified for any microwave band between 5 and 90 GHz. Gunn devices can be made to oscillate in a number of configurations. These can be in the form of coaxial resonators, waveguide cavities, and microstrip circuitry.<sup>3</sup> They can be tuned mechanically or electrically. The theory of how Gunn devices oscillate is covered in other literature.<sup>4,5,6</sup>

The type of Gunn oscillator presented in this article is a waveguide cavity oscillator. If you wish to tune a waveguide cavity oscillator over a wide range, the cavity volume formed between the diode mount and a movable back wall, in the form of an rf choke, is changed. D. Evans,<sup>7</sup> and Tsai, Rosenbaum, and Mac Kenzie<sup>8</sup> describe wideband mechanically tunable waveguide cavity oscillators. However, the other approach to waveguide cavity oscillator design is to use an iris-coupled waveguide cavity. Here the resonant cavity is formed by the iris and the diode mount. The backwall is adjusted close to the diode mount for optimum operation. The design is inherently narrow-band, tunable over 100-300 MHz. Since operation is permitted between 10.0 and 10.5 GHz, this type of oscillator presents a practical approach. Other features of the oscillator are that it is fairly straightforward in design and can be easily reproduced.

Following is a presentation of some of the ground

rules for iris-coupled waveguide oscillator design. From these, a design procedure is presented followed by testing techniques and precautions to be taken when putting the oscillator into operation.

The iris-coupled waveguide cavity oscillator is shown in **fig. 1**. The diode is mounted across the center of the broad dimension of the waveguide. Dc bias is coupled to the diode through an rf choke. The backwall, which can be moved, is usually close to the diode mount and can be adjusted for stable operation. The function of the iris is to complete the waveguide cavity while providing coupling between oscillator and load. The tuning screw located between the diode post and the iris provides a limited tuning mechanism for the oscillator.

Since the Gunn oscillator is a negative-resistance device, it will have a tendency to oscillate at more than one frequency. The idea is to reduce the number of spurious resonances and make it oscillate where you want it to. The first step in this direction is to examine what makes up the main oscillating cavity of the oscillator.

**Waveguide cavity.** The fundamental resonant mode of the cavity occurs when the distance between the iris and the effective backwall is one-half the guide wavelength. If the diode is mounted near a sidewall of the cavity, the effective backwall is somewhere between the diode post and the backwall. If, however, the diode is mounted in the cavity center, the effective backwall is in the plane of the diode mount.<sup>9</sup> This is verified by slotted-line measurements looking at the normalized impedance in the plane of the diode mount.

One end of the cavity is now defined. The other end is defined by the iris. The iris reactance can be either inductive or capacitive. **Fig. 2** shows an equivalent circuit of an iris-coupled cavity. If the iris is capacitive, the physical length of the cavity is longer than  $\frac{\lambda_g}{2}$  as shown in **fig. 2(a)**. If the iris is inductive as in **fig. 2(b)**, the actual cavity length is shorter than  $\frac{\lambda_g}{2}$ . The relationship between cavity length and iris susceptance is:<sup>10</sup>

By **Richard Bitzer, WB2ZKW**, 3 Ray Street, Milltown, New Jersey 08850

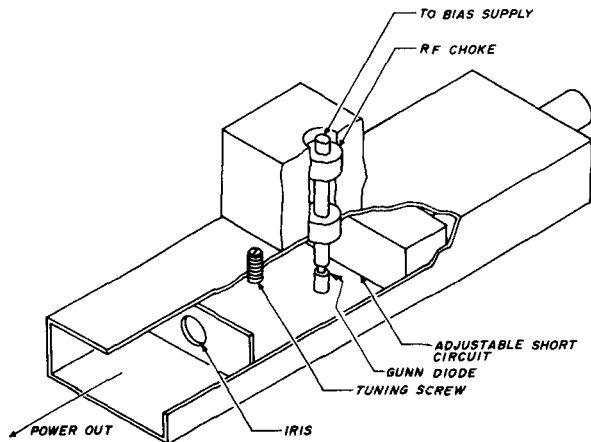

fig. 1. Simple waveguide iris-coupled oscillator. With the diode mounted across the guide center, the distance between iris and diode post is approximately one-half guide wavelength. Iris size is optimized for maximum power output while providing isolation from load mismatches. The rf choke minimizes power loss through the bias line. Backwall is adjusted to provide a stable operating point.

$$\ell = \frac{\lambda_g}{2\pi} \left[ n\pi + \frac{1}{2} \tan^{-1} \frac{2}{|b_e|} \right] \text{ (cap.) (1)}$$

$$\ell = \frac{\lambda_g}{2\pi} \left[ n\pi - \frac{1}{2} \tan^{-1} \frac{2}{|b_e|} \right] \text{ (ind.) (2)}$$

where  $\ell$  = cavity length  
 $\lambda_g$  = guide wavelength  
 $n$  = integral number  
 $|b_e|$  = absolute value of normalized iris susceptance  
 $\lambda$  = operating wavelength  
 $a$  = wide dimension of waveguide

In most cases  $n = 1$  to reduce the possibility of the oscillator operating at a lower frequency. Once the value for  $b_e$  is found, the appropriate expressions (eqs. 1 or 2) give a value for the cavity length,  $\ell$ .

The estimated value of loaded  $Q$  for an iris-coupled cavity is given by:<sup>11</sup>

$$Q_L \approx b_e^2 \frac{\pi}{2} \frac{1}{\left(1 - \frac{f_c}{f}\right)^2} \quad (3)$$

where  $b_e$  = normalized value of iris susceptance  
 $f_c$  = guide cutoff frequency,  $TE_{10}$  mode  
 $f$  = operating frequency

From the previous discussion, the cavity length,  $\ell$ , and the cavity loaded  $Q$  depend on the value given to the normalized iris susceptance.

**Iris.** An iris is an obstruction placed into a waveguide system that electrically has a value of reactance or its inverse, susceptance. Irises can take various shapes (fig. 3) and can be inductive, capacitive, or resonant. From the standpoint of ease of construction, a centered circular aperture is the simplest form to make. The circular iris is inductive and its value can be calculated; however, it's easier to use the graph<sup>12</sup> in fig. 4.

The graph gives a good approximation for the value of normalized susceptance,  $\frac{B}{Y_0}$  (that is,  $b_e$ ) as a function of the ratio of iris diameter to the broad dimension of the waveguide. This is done for various waveguide aspect ratios and various ratios of operating-wavelength-to-guide width. The values of  $b_e$  from the chart are in good agreement with measured values. Now that the iris susceptance is calculated using fig. 4, cavity length can be found.

The question is raised as to how large a hole should be made in an iris plate. Critical coupling, the point where power output is maximum, occurs when the iris area is about 25 per cent of the waveguide cross-sectional area.<sup>13,14</sup> If the hole is further enlarged, the oscillator cavity will be overcoupled with a resultant drop in output power and poor stability. On the other hand, by making the hole smaller, the cavity will become undercoupled resulting in a drop in oscillator output power.

So in determining cavity length, choose an iris area between 20 and 25 per cent of the waveguide cross-sectional area. Since the circular iris area is  $\pi d^2/4$ , the diameter can be found. The next step is to design the cavity to operate at the highest frequency of interest. The cavity can always be tuned downward by a dielectric screw tuner. The operating frequency determines the wavelength. Knowing the  $a$  and  $b$  dimensions of the guide, the value of the normalized susceptance,  $b_e$ , can be found from fig. 4. This value is then substituted into eq. 2 to find cavity length  $\ell$ .

**Rf bias-choke system.** Erratic operation, spurious responses, and power loss can be caused by an improper bias-choke design. The diode must be operated with a dc bias while decoupled from the

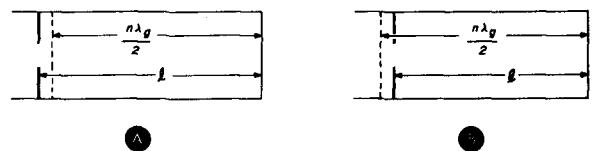

fig. 2. Equivalent circuit of an iris-coupled cavity. When the iris is capacitive, A, the actual cavity length is longer than multiples of one-half guide wavelength; when inductive, B, the actual cavity length is shorter than multiples of one-half guide wavelength.

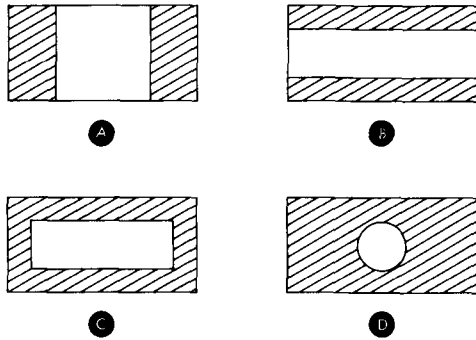

fig. 3. Various iris configurations. A and D are inductive; B and C are capacitive and resonant respectively. The circular iris in D is easiest to make.

bias supply. Early designs operated erratically and even had diode failure because of poor bias-choke design. Two common types of chokes are the radial-line choke and "dumbbell" choke. The radial-line choke requires a large circular plate parallel to the broad side of the waveguide with small separation. The radius of the radial line is approximately  $\lambda/4$ , with a configuration of an open-ended quarter-wave transmission line. The feedpoint impedance at the diode end becomes very low.

Although this type of bias-choke system is easy to

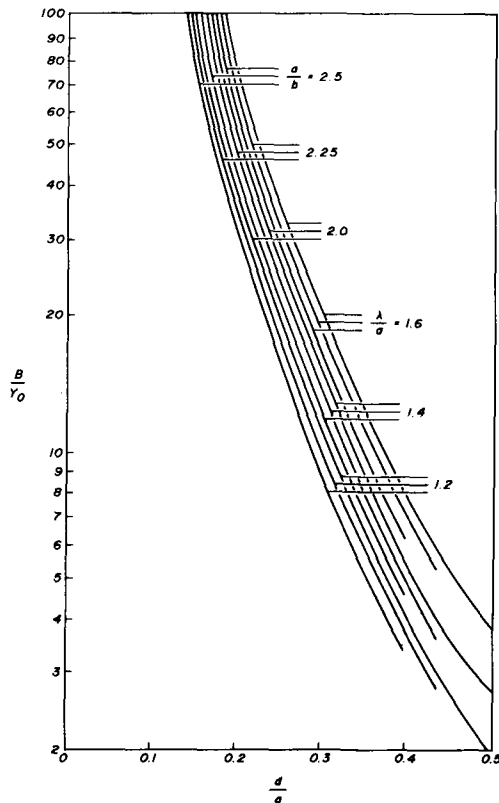

fig. 4. Relative susceptance of a centered circular aperture as a function of the ratio of iris diameter to waveguide broad dimension.

build, some radiation occurs from the open end. A more popular choke arrangement is the "dumbbell" choke, fig. 5. As the name implies, sections A, B, and C resemble a dumbbell. This choke design is basically a series of quarter-wave-long coaxial line transformers, alternating between low and high  $Z_0$  sections. The design transforms a wide variety of impedances at the feed point to an extremely low impedance at the Gunn-diode mounting point. This is necessary since the waveguide wall is a current-carrying surface.

The characteristic impedance of a coaxial line is:

$$Z_0 \approx \frac{60}{\sqrt{\epsilon_r}} \ln \frac{r_2}{r_1} \quad (4)$$

where  $r_2$  = inside radius, outer conductor  
 $r_1$  = outside radius, inner conductor  
 $\epsilon_r$  = relative dielectric constant

Since sections A and C must have close spacing with respect to the wall, a dielectric material such as Mylar tape can be used to prevent the choke from shorting the bias supply. Sections A and C will be shorter in length than section B to account for the difference in phase velocity caused by the different dielectric constant of the tape. The velocity that the wave propagates is given as:

$$v = \frac{c}{\sqrt{\epsilon_r}} \quad (5)$$

where  $v$  = velocity of propagation  
 $c$  = speed of light =  $3(10^8)$  meters/second  
 $\epsilon_r$  = relative dielectric constant

To calculate the  $\lambda/4$  sections, operating wavelength,  $\lambda$ , is found from:

$$\lambda = \frac{v}{f} \quad (6)$$

where  $\lambda$  = operating wavelength  
 $v$  = propagation velocity  
 $f$  = operating frequency

Eqs. 5 and 6 will allow you to calculate the lengths of sections A, B, and C, while eq. 4 gives the characteristic impedance of each section. The diameter of the cylindrical hole into which the choke section slides can be between 1/4 inch (6.35 mm) to 1/2 inch (12.7 mm) for X band. A compromise is to use 3/8 inch (9.5 mm).

**Diode-mounting configurations.** The diode can be mounted on a post centered in the waveguide. The post and mounted diode can excite TEM modes in the vicinity of the post, resulting in spurious responses that can cause oscillator turn-on problems. Post reactance can be eliminated if guide height is reduced to that of the diode package. How-



ever, results have shown that the tuning range is narrowed and power output drops.<sup>15</sup> If it's desirable to broadband the oscillator, a tapered or stepped post can be used. Again, because the device is a negative-resistance oscillator, broadbanding in this manner can lead to oscillation in unwanted modes and turn-on problems.

The resonant frequency of the TEM modes can be equated to post and diode height, being approximately a half-wavelength long. Mode frequency can be doubled by centering the diode on the post. The diode will cause a null in the fields at the point that makes the original post-height sections halved. However output power will drop, since mounting the diode in the post center decouples the diode. In many cases diode location on the post is left up to the experimenter.

Optimum post diameter is discussed in the literature.<sup>16</sup> Theoretical calculations verified by experimental results show that a post 0.125 inch (3 mm) in diameter gives the oscillator the broadest bandwidth. Post diameters greater than 0.150 inch (3.8 mm), reduce bandwidth over which the oscillator can operate. The power output, however, increases with post diameters greater than 0.150 inch (3.8 mm).

**Cavity backwall.** In some Gunn-oscillator designs the cavity backwall is fixed and located approximately one-half guide wavelength behind the diode post. For this configuration, some form of matching network is ahead of the diode. In the iris-coupled waveguide oscillator the backwall can also be fixed; however, this must be done by experimentation to obtain optimum results.

Once the backwall position is determined for optimum power output and stability, the position can then be fixed. From a flexibility standpoint, I found that a movable backwall permitted greater freedom of adjustment. This is particularly evident when different Gunn diodes are used in the same cavity.

Fig. 6 illustrates different movable backwall designs. Figs. 6A and B are quarter-wave choke sections, while fig. 6C is a close-fitting block that can be secured by locking screws once optimum operation is established. In fig. 6A, the quarter-wavelength sections are separated from the wall by nylon bearings. The mechanism is spring loaded, so that a constant pressure is exerted onto the choke assembly. An adjusting knob, riding on a threaded shaft, moves the choke assembly in and out.

Fig. 6B is identical to that of fig. 6A, except a dielectric is used around the entire sections that come in close contact with the waveguide walls. Note that these sections are narrower than the corresponding sections in fig. 6A because the insulated sections form a dielectric loaded guide.

Fig. 6C shows a simple block that is close-fitted in the guide. No attempt is made to insulate here; wall contact is desired with this design. In many cases, the block is cut to a depth of a quarter guide wavelength. A threaded rod acts as a handle for block adjustment.

The choke-section depth is based upon the idea that the space between guide sidewall and choke can be considered as a guide beyond cutoff (assuming  $TE_{10}$  mode). The space between the guide broad wall and choke is basically a reduced-height guide propagating in the  $TE_{10}$  mode. The relationship for  $\lambda_g$  is the same regardless of guide height. The choke depth is one-quarter guide wavelength. When air is in the dielectric,  $\lambda_g/4$  is computed from:

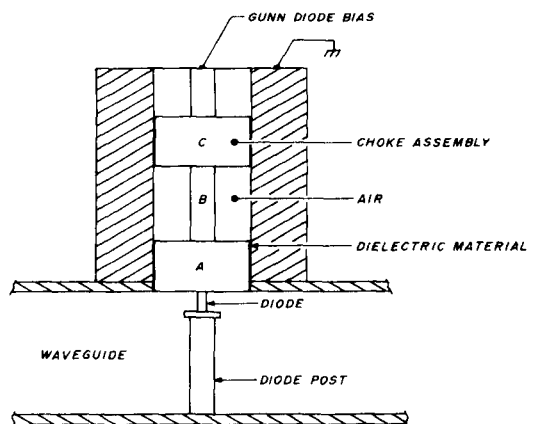

fig. 5. Cross section of the dumbbell rf choke. Sections A and C are identical. The dielectric insulates the center section from the wall. Sections A, B, and C form a coaxial transmission-line system of quarter-wavelength transformers with different characteristic impedances.

$$\lambda_g = \frac{\lambda}{\sqrt{1 - \left(\frac{\lambda}{2a}\right)^2}} \text{ for } TE_{10} \text{ mode} \quad (7)$$

where  $\lambda_g$  = guide wavelength  
 $\lambda$  = operating wavelength  
 $a$  = broad guide dimension

From eq. 7 the value for  $\lambda_g$  is divided by four, and each section in fig. 6A is  $\lambda_g/4$  long.

In fig. 6B, the value of  $\lambda_g$  for the two sections having dielectric tape wrapped around them is:

$$\lambda_{gd} = \frac{\lambda}{\sqrt{\epsilon_r - \left(\frac{\lambda}{2a}\right)^2}} \text{ for } TE_{10} \text{ mode} \quad (8)$$

where  $\lambda_{gd}$  = guide wavelength in dielectric guide  
 $\epsilon_r$  = relative dielectric constant

Here the first and third choke sections are  $\lambda_{gd}/4$ ,

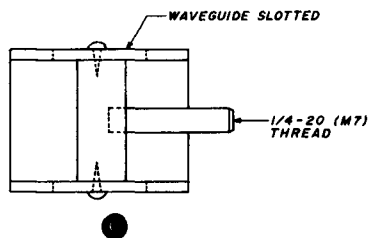
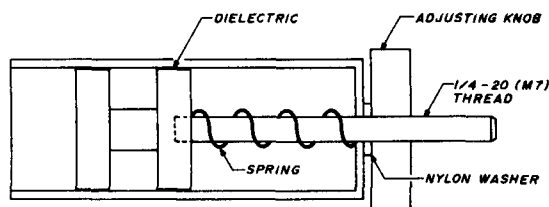
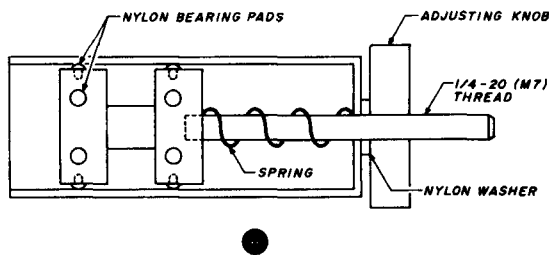

fig. 6. Different moveable backwall designs. An adjustable backwall choke assembly, using nylon pads for isolation, is shown in A. B shows a design using dielectric tape around the two sections. Wall contact is desired in the block design in C. The close-fitting adjustable backwall is locked into place by locking screws on each side of the waveguide.

while the middle section is  $\lambda_g/4$ . Eq. 8 is an approximate solution, assuming that a dielectric with a low-loss tangent is used.

**Matching section.** This device is an adjunct to the oscillator in that, if there's a considerable mismatch between oscillator and load, some sort of matching device is needed. Several techniques are used in impedance matching. Devices such as E-H tuners and slide-screw tuners, have been fairly common. However, they've been replaced in many applications by a ferrite isolator. This device exhibits low attenuation in the forward direction and high attenuation in the reverse direction. They can be made broadband and present a constant load to the oscillator despite wide variation of load mismatch. However, they're rather expensive, so a simple approach is used.

While it's narrow band, a three-screw tuner will match over a limited range of mismatch conditions.

Fig. 7 is an example of a three-screw tuner. The screws are one-quarter guide wavelength apart and are placed along the center line of the broadwall of the guide. If a wider range of impedances is to be matched,  $3/8$  and  $5/8$  guide wavelength separations can be used if space permits. The distance between the iris and the first screw of the tuner can be made  $3/8$  guide wavelength.

## oscillator design and assembly

Since an iris-coupled waveguide cavity oscillator can tune only over a portion of the 10-GHz band, several factors affect the choice of frequency. First, the frequency will tune downward with increasing bias for most diodes. Diodes are available where frequency increases with bias; these are employed where temperature compensation is required. Second, the frequency will tune downward as the tuning screw penetrates the cavity. Third, the frequency decreases with increasing temperature.

Because the effects of bias, temperature, and mechanical tuning lower the frequency, choose a frequency of, say, 50 MHz or so above the desired operating frequency. With an AFC system, the oscillator can stay locked onto either the incoming received signal or a reference signal.

**Design example.** In the following example an operating frequency of 10.350 GHz was chosen. To compensate for the effects mentioned previously 10.400 GHz became the design frequency. An iris diameter of 0.25 inch (6.35 mm) was used. Before the cavity length can be calculated from eq. 2,  $\lambda_g$  and  $b_e$  must be found:

$$\lambda = \frac{c}{f} = \frac{3 \times 10^8 \text{ m/s}}{10.4 \times 10^9 \text{ Hz}} = 1.13 \text{ inch} \\ (0.02885 \text{ meters or } 28.85 \text{ mm})$$

$$\lambda_g = \frac{\lambda}{\sqrt{1 - \left(\frac{\lambda}{2a}\right)^2}} = \frac{28.85 \text{ mm}}{\sqrt{1 - \left(\frac{28.85 \text{ mm}}{2 \times 22.86 \text{ mm}}\right)^2}} \\ = 1.464 \text{ inch } (37.18 \text{ mm})$$

From fig. 4, the value for  $b_e$  can be found, providing the following ratios are calculated:

$$\frac{d}{a} = \frac{6.35 \text{ mm}}{22.86 \text{ mm}} = 2.8$$

$$\frac{a}{b} = \frac{22.86 \text{ mm}}{10.16 \text{ mm}} = 2.25$$

$$\frac{\lambda}{a} = \frac{28.85 \text{ mm}}{22.86 \text{ mm}} = 1.26$$

Using these numbers in fig. 4,  $b_e$  is 14. Next substitute the values for  $b_e$  and  $\lambda_g$  in eq. 2 and calculate cavity length:

$$\ell = \frac{\lambda_g}{2\pi} \left[ \pi - \frac{1}{2} \tan^{-1} \frac{2}{|b_e|} \right]$$

$$\ell = \frac{37.18 \text{ mm}}{2\pi} \left[ \pi - \frac{1}{2} \tan^{-1} \frac{2}{14} \right]$$

0.717 inch (18.2 mm)

The tuning screw can be placed anywhere between the diode post and the iris; however, a position of 0.22 inch (5.6 mm) from the iris was chosen, since placing it too close to the diode post would cause unstable operation.

**Bias choke and diode post.** Referring to fig. 5, the lengths of sections A, B, and C are calculated. Since sections A and C are sections of coaxial line with Mylar insulation, propagation velocity will be altered by  $\sqrt{\epsilon_r}$  of the Mylar. Using eqs. 5 and 6:

$$v = \frac{c}{\sqrt{\epsilon_r}} = \frac{3 \times 10^8 \text{ m/s}}{\sqrt{2.8}}$$

$$= 5.9 \times 10^8 \text{ feet/second}$$

$$(1.79 \times 10^8 \text{ meters/second})$$

$$\lambda = \frac{v}{f} = \frac{1.79 \times 10^8 \text{ m/s}}{10.25 \times 10^9 \text{ Hz}}$$

$$= 0.688 \text{ inch (17.5 mm)}$$

In the above instance, the frequency for the middle of the 10-GHz band was chosen, i.e., 10.25 GHz. The length of sections A and C are  $\lambda/4$ , therefore:

$$\frac{\lambda}{4} = \frac{17.5 \text{ mm}}{4} = 0.17 \text{ inch (4.4 mm)}$$

Section B (fig. 5) has air dielectric, therefore  $\sqrt{\epsilon_r} = 1$  and its length becomes:

$$\lambda = \frac{c}{f} = \frac{3 \times 10^8 \text{ m/s}}{10.25 \times 10^9 \text{ Hz}} = 1.15 \text{ inches (29.27 mm)}$$

$$\frac{\lambda}{4} = \frac{29.27 \text{ mm}}{4} = 0.28 \text{ inch (7.3 mm)}$$

The characteristic impedance must be low for section A and C and high for section B. Based on choke design appearing in D. Evan's articles,<sup>17,18,19</sup> the outer diameter of the choke cylinder is 0.375 inch (9.525 mm). Sections A and C are chosen so that the spacing accommodates one or two layers of Mylar tape. The diameters of A and C are then 0.360 inch (9.144 mm). The diameter of B is approximately 1/3

of that of A and C. Section B diameter is chosen as 0.125 inch (3.175 mm). Using these diameters in eq. 4, the characteristic impedances of the sections are:

Sections A and C:

$$Z_0 = \frac{60}{\sqrt{\epsilon_r}} \ell n \frac{r_2}{r_1}$$

$$Z_0 = \frac{60}{\sqrt{2.8}} \ell n \frac{9.525 \text{ mm}/2}{9.144 \text{ mm}/2} = 1.46 \text{ ohms}$$

Section B:

$$Z_0 = \frac{60}{\sqrt{1}} \ell n \frac{9.525 \text{ mm}/2}{3.175 \text{ mm}/2} = 65.9 \text{ ohms}$$

The section above C maintains the same diameter as in section B and is made long enough to connect to a BNC connector. The Gunn diode connects to section A. Fig. 8 is an outline dimension for a typical low-to-medium power Gunn diode package. Each end is 0.061 inch (1.56 mm) in diameter. The mating hole in section A is made slightly larger; i.e. 0.0625 inch (1.59 mm) in diameter and at least as deep. The diode post is made from a 10-32 (M5) screw. The end opposite the head has a hole drilled out to 0.0781 inch (1.98 mm) diameter. The depth of the hole is at least 0.0625 inch (1.59 mm). The larger hole is needed to avoid fracture of the diode caused by misalignment errors.

The quarter-wave dimensions for movable back-wall choke assembly are based on the design shown in fig. 6B. Here the first and third sections are loaded with Mylar tape. The inner guide dimension is 0.9 x 0.4 inch (22.86 mm x 10.16 mm). The choke

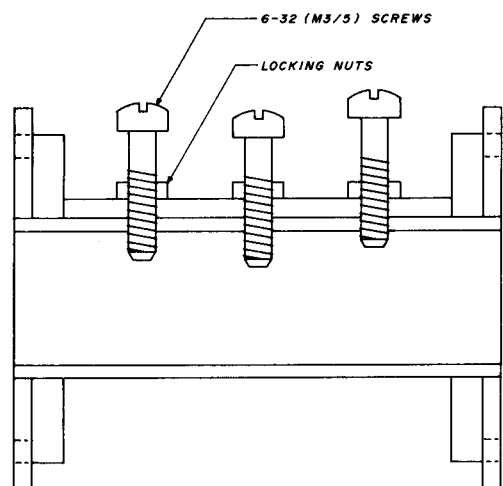

fig. 7. Cross section of the triple-screw matching section. Screws are one-quarter guide wavelength apart and are placed along the centerline on the guide broad wall. Spacings of 3/8 and 5/8 guide wavelengths can be used if space permits, since such spacings match a wider range of impedances.

block must be made smaller by the amount of the Mylar tape. If 5-mil-thick tape is used, the choke block is made with at least a 7-mil clearance on each side. These blocks then become  $0.886 \times 0.386$  inch ( $22.50 \text{ mm} \times 9.80 \text{ mm}$ ) in their cross-sectional dimensions. Their length is computed from eq. 8:

$$\begin{aligned} \lambda_{gd} &= \frac{\lambda}{\sqrt{\epsilon_r - \left(\frac{\lambda}{2a}\right)^2}} \\ &= \frac{28.85 \text{ mm}}{\sqrt{2.8 - \left(\frac{28.85 \text{ mm}}{2 \times 22.86 \text{ mm}}\right)^2}} \\ &= 0.733 \text{ inch (18.62 mm)} \end{aligned}$$

$$\frac{\lambda_{gd}}{4} = \frac{18.62 \text{ mm}}{4} = 0.183 \text{ inch (4.66 mm)}$$

This value is the length of the first and third sections. The middle section length is computed from eq. 7:

$$\begin{aligned} \lambda_g &= \frac{\lambda}{\sqrt{1 - \left(\frac{\lambda}{2a}\right)^2}} \\ &= \frac{28.85 \text{ mm}}{\sqrt{1 - \left(\frac{28.85 \text{ mm}}{2 \times 22.86 \text{ mm}}\right)^2}} \\ &= 1.464 \text{ inch (37.18 mm)} \end{aligned}$$

$$\frac{\lambda_g}{4} = \frac{37.18 \text{ mm}}{4} = 0.37 \text{ inch (9.30 mm)}$$

The remaining calculation is that of the matching transformer or tuner. The first screw of the three-screw tuner shown in fig. 7 is approximately  $3/8 \lambda_g$  away from the iris. The distance between the screws is  $\lambda_g/4$ . Using 10.25 GHz, a band center,  $\lambda_g = 1.5$  inches (38.10 mm). The distance between screws is 0.375 inch (9.5 mm), and between screw and iris is 0.563 inch (14.3 mm). When the sections were built, this dimension was closer to 0.590 inch (15 mm). The discrepancy produced no apparent problem.

## construction

Now that all critical dimensions have been calculated, figs. 9A and B show the oscillator assemblies. The oscillators operate around 10.4 GHz and 10.3 GHz respectively. Fig. 9B differs from A mainly in backwall design. The construction of the oscillator follows a sequence of steps.

**Cavity.** Referring to fig. 9A, the cavity assembly is made from a piece of WR-90 waveguide about 2.5 inches (63.5 mm) long. If you have a drill press, milling machine, and lathe, the job becomes easier. However, much of the construction can be done if

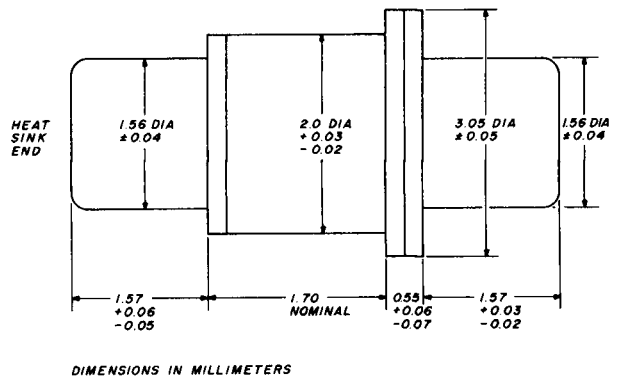

fig. 8. Outline dimensions of a typical low-power Gunn diode encapsulation. Diodes with output power ratings greater than 50 mW (such as the Alpha Industries DGB-6835C) have the cathode on the heatsink end. Those with less than 50 mW output power ratings (such as the Microwave Associates MA-49508) have the anode on the heatsink end.

you have some hand tools and a drill press.

Square off both ends of the guide and deburr. Obtain a piece of brass stock  $0.75 \times 1 \times 1$  inch ( $19 \times 25.4 \times 25.4$  mm) and another  $0.125 \times 0.75 \times 1$  inch ( $3.175 \times 19 \times 25.4$  mm). Fit a UG-39/U cover flange over one end of the guide and clamp the two brass pieces on each side. Make a waveguide cap for the other end of the guide out of a piece of  $1 \times 0.5$  inch ( $25.4 \times 12.7$  mm) flat stock 60 mils thick. Place this assembly vertically on a fire brick. Rest the waveguide cap over the open waveguide. The flange end should be flush with the brick. Solder the assembly using a torch and let cool. File the flange end smooth; or if a milling machine is available, mill it smooth.

Measure a point 0.717 inch (18.2 mm) back from the flange and center it on the broad dimension of the guide on the 1 inch (25.4 mm) high block behind the flange. Drill a small pilot hole through the entire assembly using a  $3/32$ -inch (2.38 mm) diameter drill. This ensures the alignment of the bias choke with the diode post. On the bottom side, drill and tap for a 10-32 (M5) thread. On the choke block, drill a  $3/8$ -inch (9.525 mm) diameter hole.

A word of caution here — start by drilling progressively larger holes until the required diameter is reached. Use a slow drill speed and oil. The drill has a tendency to grab, and you may have to anchor the assembly to the work table on the drill press.

Next, locate the holes of a UG-290/A BNC connector on the top of the bias-choke housing. Drill and tap four 4-40 (M3) screws 0.5 inch (12.7 mm) deep. Drill and tap a 6-32 (M3/5) hole 0.22 inch (5.6 mm) back from the flange face and centered on the broad-wall in front of the bias block for a 6-32 (M3/5) nylon tuning screw. Drill a  $1/4$ -20 (M7) clearance hole cen-

tered on the waveguide cap to accommodate the shorting choke assembly screw mechanism.

**Iris.** The iris is made from thin copper foil at least 10 mils thick. One of the UG-39/U flanges can be used as a pattern as an outline to locate the center. Cut out the iris and scribe a mark locating the center of the iris hole. Carefully drill a 0.25-inch (6.35 mm) diameter hole. Then drill out the four corner holes to clear 8-32 (M4) screws. (Later, the iris plate will be clamped between the oscillator assembly and the tuner assembly.)

**Bias choke.** To make the bias choke, a lathe is handy since it makes the job easier but isn't absolutely necessary. Obtain a 3/8-inch (9.525 mm) diameter brass rod about 4 inches (101.6 mm) long and square off one end. Referring to **fig. 5**, mark off sections A, B, and C. These will be 0.172 inch (4.4 mm) 0.288 inch (7.32 mm), and 0.172 inch (4.4 mm) respective-

ly. Above section C, a length of 0.236 inch (6 mm) can be cut back and attached to the bias connector.

Sections A and C are reduced in diameter 0.360 inch (9.144 mm) and B and the section above C to 0.125 inch (3.175 mm) in diameter. A 0.0625 inch (1.59 mm) diameter hole is drilled on center in the end of section A. Wrap a layer of Mylar tape around A and C. Fit the bias choke into the bias block and set it flush with the inside top of the waveguide. Cut the section of the choke above section C to mate up with the center conductor on the BNC connector and solder. The assembly is secured into place by four 4-40 (M3) screws.

**Diode post.** The diode post is made from a 10-32 (M5) screw with a 0.078 inch (1.98 mm) diameter hole drilled into the center of the screw opposite the head. When the diode post is put into position, a 10-32 (M5) locking nut secures it.

**Backwall.** The movable backwall is made from two brass blocks 0.886 x 0.386 inch (22.50 x 9.80 mm) in cross section by 0.183 inch (4.66 mm) long, and a 2.5 inch (63.55 mm) long 1/4-20 (M7) threaded rod. Drill a hole, centered on the face of the block, and tap it for 1/4-20 (M7) thread through one block and half way through the other. Screw the rod into one block. Screw down the other block until it's about 0.366 inch (9.30 mm) from the first block. Wrap a layer of Mylar tap around each block. Slide a spring over the free end of the 1/4-20 (M7) rod.

The assembly is backed into the flange end of the oscillator cavity, and the rod goes through the clearance hole in the cap end of the waveguide. An adjusting knob, threaded for 1/4-20 (M7) is screwed on and used to move the choke assembly. A 1/4-20 (M7) is screwed on and used to move the choke assembly. A 1/4-20 (M7) locking nut is secured when the optimum position for the choke is found.

Place the diode, with heat-sinking compound, into the diode post screw. Carefully insert the screw and diode and lock into place. Do not exert too much pressure (see "precautions"). Lock into place with the locking nut. Insert the 6-32 (M3/5) nylon tuning screw at this point.

**Tuner.** The triple-screw tuner is made from a 2-inch (50.8 mm) section of WR-90 guide. The ends should be squared off and deburred. Solder a brass section 1.125 inch (28.58 mm) long by 1 inch (25.4 mm) wide by 0.125 inch (3.175 mm) thick onto the broad side of the waveguide between the two flanges. Clamp the plate to the waveguide, slide the flanges over each end of the waveguide and solder the assembly. Drill and tap three 6-32 (M3/5) holes centrally along the broad waveguide face through the block according to the locations in **fig. 9A**. Deburr the holes and

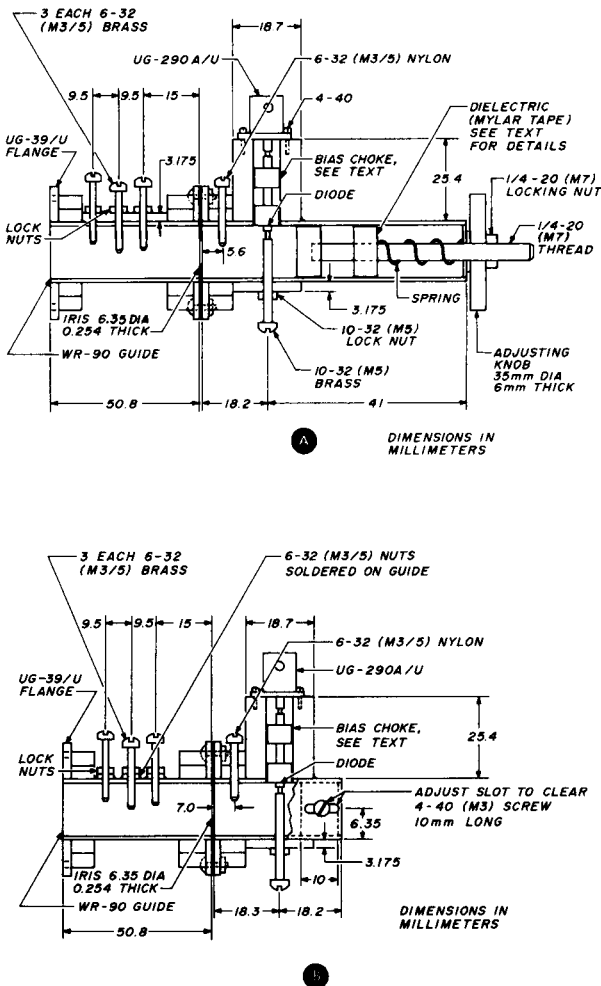

**fig. 9.** Assembly drawings of two Gunn oscillators. A design using an adjustable choke plunger backshort is shown in A. The oscillator in B has an adjustable contacting backshort that can be locked into place.

insert three 6-32 (M3/5) screws 0.75 inch (19.05 mm) long with locking nuts. Connect the tuner to the oscillator section. Place the iris plate as shown and use four 8-32 (M4) screws and nuts to hold the assembly together.

This completes the oscillator assembly. The unit in fig. 9B is constructed in the same manner except for the backwall. Here a block closely fitting the inside of the guide is clamped into place on each side by a 4-40 (M3) screw.

### test techniques and results

The type of tests that can be made depends on what equipment is available. If you've been able to obtain a fair amount of X-band test equipment, including a frequency meter and a slotted line from surplus dealers or flea markets, you're in good shape. Otherwise, a minimum of test equipment can be borrowed or made. For making some of your X-band test equipment consult reference 20.

**Reflectometer test.** For those who have access to

an X-band reflectometer, looking at the reflected power from the cavity will show where the oscillator cavity resonates and where any spurious resonances occur within the 8.5-12.4-GHz band. Moving the backwall and tuning screw gives an indication of the tuning range. However, when power is applied to the oscillator, these frequencies will shift slightly. If a coaxial-to-waveguide transition is available, a transmission test is made to determine 10-GHz leakage out of the bias choke. The results on both oscillators of fig. 9 indicate the leakage is down by 60 dB or more.

**Slotted line measurements.** If a slotted line is available, the reactance of the iris can be measured. I built several irises and the differences between calculated and measured reactance were within 5 per cent. If the values of normalized reactance are calculated carefully from fig. 4, they should be within 5 per cent of the actual values.

**Swept-bias tests.** Probably the most important testing technique used on Gunn oscillator design is

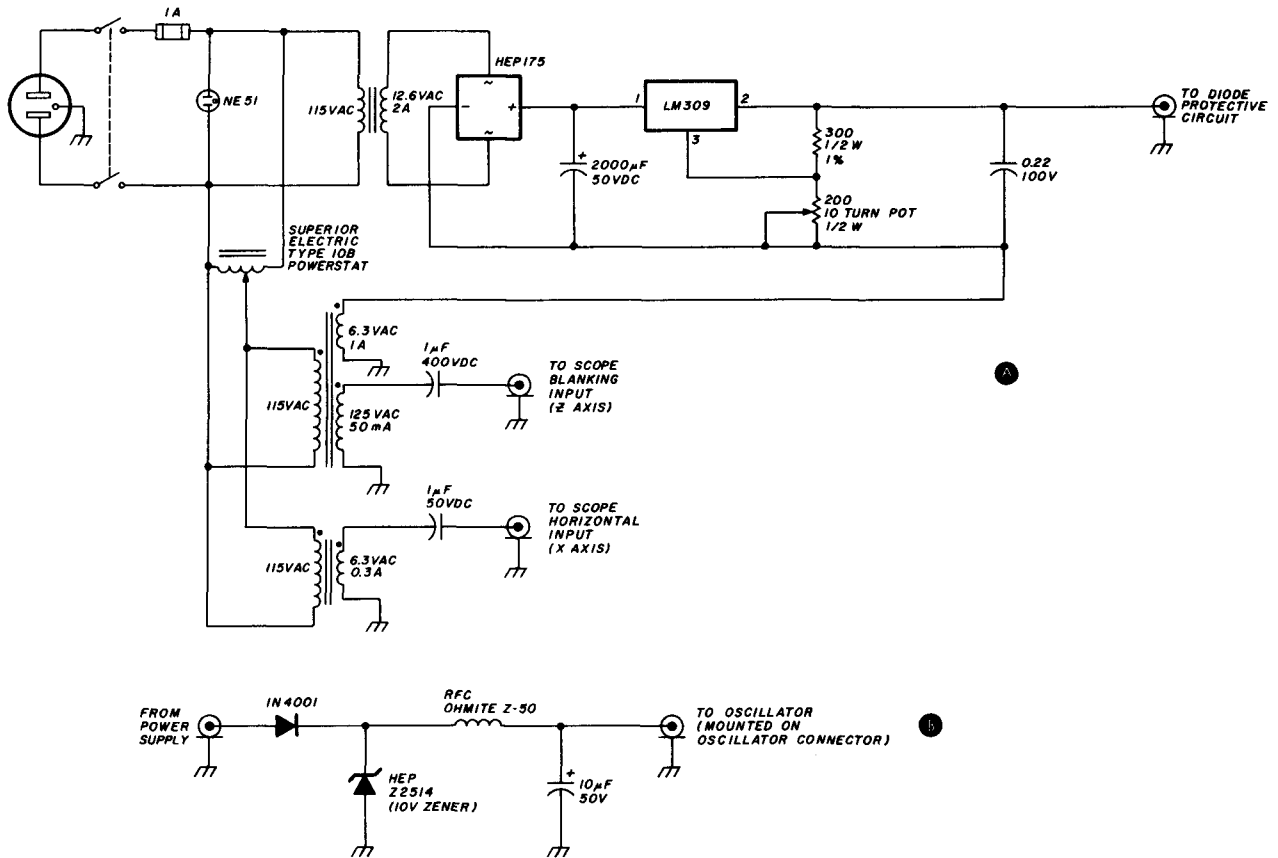

fig. 10. Schematic of the swept bias supply for testing Gunn-diode oscillators. In (A), a dc supply provides regulated dc voltages up to 500 mA. The 6.3 Vac winding of a transformer provides a variable ac supply, which is in series with the dc supply. Both supplies are connected to the Gunn oscillator through the protective circuit in (B).

the swept-bias test setup. A variable bias voltage is applied to the oscillator while its output is monitored with a detector and frequency meter. The swept response is displayed on an oscilloscope. Using such a test setup, the oscillator can be made to look into various loads while making different adjustments toward a stable operating point.

Connect the oscillator and tuner to a load through a directional coupler. Connect a frequency meter and detector to the directional-coupler coupling arm.

The swept-bias supply circuit shown in **fig. 10A** is made of several supplies. A dc supply provides a regulated 5-10 volts dc. The supply can also provide up to 500 mA of current. The 6.3 Vac winding of a transformer, providing a variable ac supply, is in series with the dc supply. Both are connected across the Gunn diode oscillator through the protective circuit, **fig. 10B**. Provisions are made for synchronized sweep voltage and a blanking voltage. Correct winding sense must be observed on the transformer windings to ensure proper sweep direction and blanking.

The protective circuit has a diode in series to protect the Gunn diode from reverse bias voltages and a zener diode to protect it from overvoltage in the forward-bias direction. The Z-50 choke and electrolytic capacitor ensure that a low impedance is presented to the oscillator and prevents buildup of dangerous voltage levels from parasitic resonances.

The protective circuit is connected to the swept source through a coaxial cable. A dummy load is then connected to the protective circuit. The dc voltage is set to 5 volts, and the sweep voltage is adjusted for 6 volts peak-to-peak if the MA-49508 diode is used, or 10 volts peak-to-peak if the DGB-6835C diode is used.

Note the powerstat settings for these ac voltages. Set the ac voltage to zero, turn off the supply, and remove the dummy load. Note: The protective circuit parts mount onto the Gunn oscillator. A matched load is used on the Gunn oscillator setup, and the nylon screw is backed out so that it's even with the inside top wall of the waveguide. The protective circuit box is connected to the oscillator. Turn on the power and advance the swept voltage to the preset position. Move the backshort until a stable swept response, shown in **fig. 11D**, is obtained. (**Figs. 11A** through **11C** show various stages of *misadjustment*.) The screws on the tuner can be adjusted for optimum output power while maintaining oscillation. If a particular antenna is to be connected, turn off the supply, connect the antenna, turn on the supply and make adjustment.

**Fig. 11D** shows that, under proper operation, the onset of oscillations starts abruptly once the bias voltage exceeds the Gunn-diode threshold voltage.

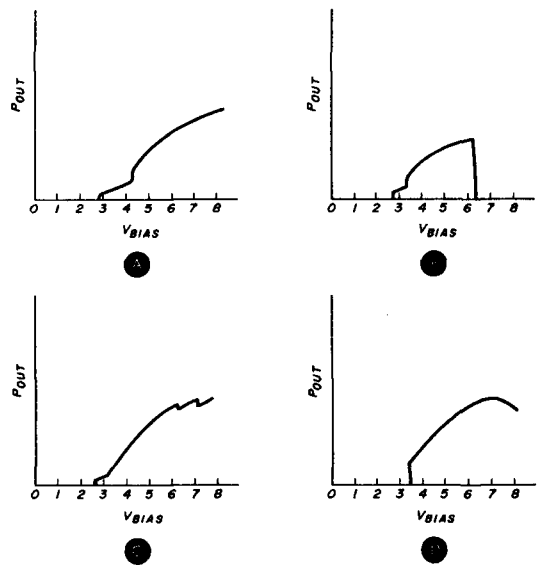

**fig. 11.** What to expect while running tests. Graphs A through C show respectively poor starting characteristics, oscillator-to-load mismatch, and backwall partially under the bias choke. Graph D shows the proper relationship between power output and bias.

As the bias voltage increases, output power increases to a peak and drops suddenly. Frequency usually decreases with increased bias voltage.

Modulation sensitivity tests were performed on the two types of Gunn diodes. The MA-49508 diode modulation sensitivity measurement was 15.6 MHz/volt, while the DGB-6835C modulation sensitivity measurement was 11.7 MHz/volt (both at room temperature).

For comparison, the published data on these diodes indicate an average modulation sensitivity around 7 MHz/volt at room temperature. The current through the diode remained fairly constant during these measurements.

I made a rough check of temperature effect on the oscillation frequency. The MA-49508 diode frequency drift with temperature was measured at  $-290$  kHz/degree C compared to the maximum of  $-350$  kHz/degree C on the data sheet. The DGB-6835C diode measured  $-0.87$  MHz/degree C to the maximum  $-1$  MHz/degree C on its data sheet.

### some precautions

The Gunn diode, like any semiconductor device, can be damaged by an electrostatic discharge. Therefore, use care when handling the diodes. Mechanically, the diodes are fairly rugged upon compression. However, they can be damaged by shear fracture. This particular failure mode occurs when placing the diode into the oscillator cavity and tight-

ening the diode post screw too much, especially if some axial misalignment exists in the diode-socket holes.

Check diode polarity before power is applied. In many cases positive bias with respect to ground is used. The medium- and higher-power diodes, such as the Alpha DGB-6835C, are heat sunked at the cathode end. The diode cathode end makes firm contact with the diode post, which is usually a good heat-sink.

On the other hand, a lower-power diode, such as the MA-49508, is constructed with the heatsink on the anode end. It's important to note that, with this type of diode configuration, the diode is physically reversed inside the package. Therefore, if the cathode end is the grounded electrode, the package must be *physically reversed* before mounting it into the oscillator. If this is not done, the diode will be reversed-biased and will be damaged.

Another cause of diode damage is parasitic oscillation. Since the Gunn oscillator is a negative resistance device, oscillations will occur at any spurious resonance that exists from hf to the microwave frequencies. Oscillations can exceed the maximum bias voltage on the diode. If not by-passed at the bias choke cold end, any length of bias line can form a resonant system, and the oscillator may put out power at that particular frequency.

For this reason, it's desirable to mount any modulation/bias circuitry close to the oscillator. Any bias modulation circuit should present a low impedance to the Gunn oscillator. Check with the Gunn diode manufacturer for their recommended protection circuit.

One very important precaution must be mentioned regarding Gunn oscillators (or any microwave oscillator). *Do not* look into the open end of the waveguide while power is applied to the oscillator. Close up, rf power density can exceed OSHA's  $10mW/cm^2$  safety limit. Fortunately, the rf power density falls off to a safe level a short distance from the oscillator. Your eyes are especially susceptible to damage from rf power radiation, so never look into an open waveguide or stand in front of a microwave antenna!

## conclusion

I've presented some of the details in the design of a Gunn oscillator. Some of the parameters and conditions for building a working oscillator are given. Also presented is a detailed design and assembly description of the oscillator. Test results are given, and some precautions are stated since it's possible to damage these devices if not properly treated.

Detailed circuits to drive and modulate the diode were not presented, since this is a different subject.

Further information can be found in references 21-27. The main purpose of this article was to present how a Gunn oscillator can be built and tested.

## acknowledgments

I wish to thank Mr. Mark Crandell of Hughes Aircraft Corp. for his helpful advice and information discussions. I also want to thank Mr. Richard Wade of Microwave Associates, and Mr. Richard Gerrish of Alpha Industries, for their advice and for providing the diode engineering samples. My appreciation also goes to Mr. George Cutsogeorge, W2VJN, for his advice on the circuit design used in the test equipment.

## references

1. How to Build a Gunn Oscillator, *Micronotes*, Microwave Associates, Vol. 11, No. 2, March, 1974.
2. A.A. Sweet, "How to Build a Gunn Oscillator," *Microwave System News*, October/November, 1973, pages 28-32.
3. *Gunn-Effect Technology*, Plessey Optoelectronic and Microwave Application Notes, Publication PS1875, 1980.
4. S.Y. Narayan and F. Sterzer, "Transferred Electron Amplifiers and Oscillators," *IEEE Transactions MTT*, Vol. MTT-18, No. 11, November, 1970, pages 773-783.
5. H. Pollman, et al., "Load Dependence of Gunn-Oscillator Performance," *IEEE Transactions MTT*, Volume MTT-18, No. 11, November, 1970, pages 817-827.
6. W. Tsai and F.J. Rosenbaum, "Amplitude and Frequency Modulation of Waveguide Cavity CW Gunn Oscillator," *IEEE Transactions MTT*, Volume MTT-18, No. 11, November, 1970, pages 877-884.
7. D. Evans, G3RPE, "Practical 10-GHz Gunn Oscillators," *Radio Communication*, May, 1974, pages 288-295.
8. W. Tsai, et al., "Circuit Analysis of Waveguide Cavity Gunn-Effect Oscillator," *IEEE Transactions MTT*, Volume MTT-18, No. 11, November, 1970, pages 808-817.
9. See reference 1, page 10 and reference 2, page 35.
10. J. Altman, *Microwave Circuits*, D. Van Nostrand and Co., Inc., New York, 1964, pages 233-236.
11. See reference 3, page 8.
12. N. Marcuvitz, *Microwave Handbook*, MIT Radiation Laboratory Series, Volume X, Chapter 5, 1948, pages 238-243.
13. See reference 2, page 35.
14. See reference 3, page 8.
15. See reference 2, page 35.
16. See reference 8, page 813.
17. See reference 7, pages 289-291.
18. D. Evans, G3RPE, "A Simplified 10-GHz Gunn Oscillator," *Radio Communication*, February, 1976, page 123.
19. D. Evans, G3RPE, "Getting Started on the 10-GHz Band," *VHF Communications*, January, 1977, pages 19-29.
20. *VHF-UHF Manual*, Chapter 8, Radio Society of Great Britain, 3rd Edition.
21. H.V. Schurmer, *Microwave Semiconductor Devices*, Wiley-Interscience Series, Chapter 8, *Gunn-Effect Devices*, John Wiley and Sons, Inc., New York, 1971.
22. J.R. Fisk, W1HR, "Solid State Microwave RF Generators," *ham radio*, April, 1977, pages 10-22.
23. K.H. Hirschelmann, DJ700, "10-GHz Transceiver for Amateur Microwave Communications," *ham radio*, August, 1978, pages 10-15.
24. J.R. Fisk, W1HR, "10-GHz Gunnplexer Transceivers — Construction and Practice," *ham radio*, January, 1979, pages 26-42.
25. D.G. Fink, *Electronic Engineer's Handbook*, First Edition, McGraw-Hill Co., New York, 1975, pages 9-60; 9-68 to 9-70.
26. M.J. Lazarus, et al., "Having a High-Quality V-Band Link and Low Cost Too," *Microwaves*, November, 1972, pages 52-53.
27. M.R. Inggs, "Self-Oscillating Mixer Cuts Antenna Test Costs," *Microwaves*, April, 1978, pages 100-102.

ham radio



# AGL Electronics

DALLAS, TEXAS  
15 miles from South Fork Ranch

YOUR FULL SERVICE DEALER

## The Price Is Right, the Class Is Extra . . .

AGL Electronics deals in all Ham equipment of the highest quality, and the service and attention are all Extra Class. Our entire staff are holders of Extra Class Amateur licenses, and they've all been dealing in Ham equipment for years.

"Just whatever y'all want, we got it."

**SANTEC, YAESU, ALPHA, ICOM, HY-GAIN,  
SWAN, DENTRON, BIRD, AND MORE.**

We've got big discounts,  
quick processing, expert  
know-how and Extra Class.

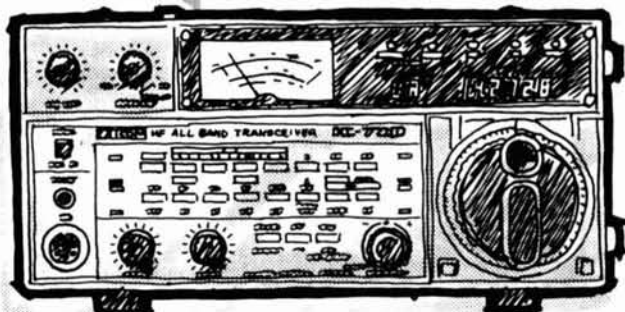

## ICOM IC-720

ICOM's big-feature HF transceiver that synthesizes all modes and all bands. Two VFO's built-in. Simplex, duplex and RIT.

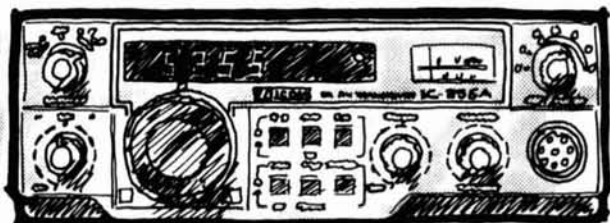

## ICOM IC-255A

ICOM delivers a full 25W to mobile FM. Two VFO's built-in. Five memory channels with memory scan, adjustable speed, and auto-stop. Power to the mobile operators!

## YAESU FT-707

Yaesu's newest multi-mode transceiver, with a full 100 W output on 80 - 10 meters. Shown here with optional FV-707DM VFO and scanning microphone.



**"WAYFARER"**

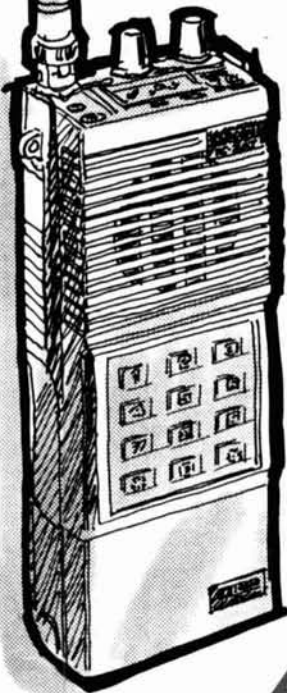

## ICOM IC-2AT

The new synthesized 2 meter hand-held, complete with factory installed tone pad. The most affordable 800 channels in Amateur Radio, with 1.5 W output high and .15 W low.

## ALPHA 76A

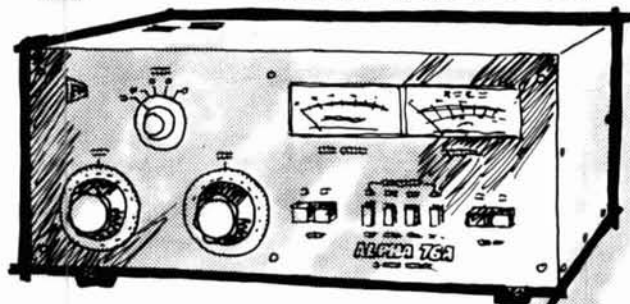

The high frequency linear amplifier with true continuous duty. 2+ KW PEP. 1 KW Locked-Key. 15 through 160 Meters. "Powerhouse".

Ask us about the new **Santec HT-1200**.

For quick shipment, call today: **800-527-3418**

AGL Electronics, 13929 N. Central Expressway, Suite 419, Dallas, Texas 75243, (214) 699-1081, We'll do it right.

© 1980, Cathay Graphics Group

AGL Electronics is located only in Dallas and has never been associated with any other dealer.

# measuring capacitance of electrolytic capacitors

Some simple math  
and a volt-ohmmeter  
make it possible  
to evaluate  
your electrolytics

You can build or buy many instruments that will tell you, with reasonable accuracy, the value of a capacitor. The capacitance of electrolytics is not easily determined, however, because they are polarized and tend to have sizeable leakage current. The following material provides a method for evaluating electrolytic caps.

## the electrolytic capacitor

Electrolytic capacitors are made of either aluminum or tantalum electrodes and an electrolyte. Boric acid is the usual electrolyte used with aluminum, and sulfuric acid is frequently used with tantalum. The active electrode may be etched; or in some cases, tantalum is formed as a porous plug. In either case, a thin insulating layer is formed on the active electrode. This layer acts as the dielectric in which the capacitive energy is stored. In a well-behaved electrolytic cap, this thin layer looks a lot like a rectifier. That is, current flow in the polarized direction is small, while in the reverse direction it can become quite large. It is this polarized state which makes bridge-type capacitance measurements difficult.

## uses

Because it's possible to obtain a large quantity of microfarads in a small package, electrolytics are used

as filter elements in power supplies. Here they function as energy-storage devices, charging when the voltage is high then supplying current when the voltage starts to drop. Electrolytics are also used as coupling elements. The large capacitance acts as a low alternating-frequency impedance between two points in a circuit where a difference in direct-current potential exists. In effect, this application also uses the capability of the electrolytic to store energy.

Nothing lasts forever, and this is particularly true of electrolytic capacitors. Loss of liquid, degeneration of the dielectric film, and abuse may drastically change the basic capacitance of the unit. The question then is, How do you measure the capacitance of an electrolytic? One answer, which goes back to fundamentals, is to measure its *energy storage ability*.

## mathematical derivation

Almost every Radio Amateurs' handbook gives the relationship between supply voltage, voltage across a capacitor, and time as a function of the charging resistance. This is an exponential relationship, but need not cause concern for the nonmathematically inclined. If you're interested in the basic math, finish this section; if not, just jump to the next.

First, the resistance and capacitance (RC) involved in a charge or discharge circuit, when multiplied together, give what is called the "time constant." If you have a large value of resistance, the time to charge or discharge will be long. The same may be said for capacitance. If the RC time constant is large, the time to charge or discharge is large.

We'll concern ourselves with discharge, in which the voltage across a capacitor with a shunt resistor is expressed as follows:

$$V = \frac{e_0}{\exp(t/RC)} \quad (1)$$

The term  $e_0$  is the voltage to which the capacitor was charged at *time zero*. *Exponent* ( $t/RC$ ) is 2.718 raised to the value of  $t/RC$ . Here  $t$  is the elapsed time in seconds since the resistance and capacitance started to discharge. Note that if  $t$  is just equal to  $RC$ , we have 2.718 raised to unity power, or simply 2.718.

By Jerome H. Hemmye, KP4DIF, Box 5145  
CAAM, Mayaguez, Puerto Rico 00708

With the technical details out of the way we can now attack the problem. If we measure the time required for a capacitor to reach 1/2.718 of the voltage to which it was originally charged, then we know the value of the product of the resistance and capacitance. Divide the time by the resistance and you end up with the capacitance. Simple, isn't it?

### measurement example

Now for a practical example. Suppose you use a volt ohmmeter with a 20,000-ohm/volt dc sensitivity, and a capacitor has a rated voltage of 35 volts. You'll use the 50-volt scale, so the effective resistance of the meter across the capacitor will be 50 times 20,000 or  $10^6$  ohms. This is a rather large resistance if the capacitor is several thousand microfarads, since the time constant will be several thousand seconds. Use a 47-k resistor in parallel with the meter so that the  $R$  in the circuit is

$$R = \frac{1}{\left(\frac{1}{10^6} + \frac{1}{4.7 \times 10^4}\right)} \text{ ohms}$$

$$= 4.49 \times 10^4 \text{ or } 44,900 \text{ ohms}$$

(round off to 45 kilohms)

We'll assume a) that the capacitor to be tested has been charged long enough so that it is reformed and up to capacitance, and b) we'll start with 35 volts. The voltage at which timing will be stopped will be 35/2.718, or 12.88 volts.

Connect the VOM across the capacitor and the 47k resistor, charge the capacitor to 35 volts, then note the time at which you remove the power from the circuit. Note that you must remove one lead from the power supply. Simply turning off the supply is not enough. Now watch the voltage. When it reaches 12.88 volts, again note the time. The length of time elapsed, in seconds, is the time constant. Suppose it was 83 seconds. This value divided by the resistance, 45 kilohms, is 1844 microfarads, the effective capacitance of the unit being measured.

### closing remarks

This method of measurement doesn't take into account any leakage effects, so the capacitance you measure may be a bit less than the actual dynamic capacitance. Also recognize that, when dealing with high-voltage capacitors, there is danger of lethal shock and you should be extra careful of any voltage over, say, 15 volts. Another precaution concerns direct shorting a capacitor. Most units will survive the current surge from a screwdriver short; however some may not and it's better to use a resistor than to burn up a screwdriver.

ham radio



## Kitty's September Suggestions

### BARRY'S HAS HAND-HELDS

Yaesu FT-207R  
Icom IC-2AT

Tempo S-1, 2, 5  
Encomm HT-1200

Come to **BARRY'S** for your  
**YAESU** transceivers and receivers.



The outstanding **FT-707** or consider the **FT-107** or the **NEW 9-Band FT-101ZD**

See the **Yaesu FRG-7000** and the top rated\* **FRG-7** receivers.

**BARRY** has the exciting new **ASTRO 150A**

See the **SANTEC HT-1200**  
System from **Encomm** at **Barry's**.

It's **Barry's** for the **Drake TR/DR-7** and **R-7**

**CW Ops** — we've got **NYE keys** and  
**Bencher paddles**

## BARRY'S HAS TUBES - LOTS OF TUBES!!!

### Our lines include:

AEA	DRAKE	MOSLEY
ALLIANCE	ETO	MURCH
ANTENNA	EIMAC	ROBOT
SPECIALISTS	ENCOMM	ROHN
ASTRON	E-Z WAY	SHURE
B & W	HUSTLER	STANDARD
BIRD	HY-GAIN	SWAN
COLLINS	ICOM	TEMPO
COMMUNICATIONS	KDK	TRI-EX
SPECIALISTS	KLM	YAESU
CUSHCRAFT	KANTRONICS	VHF ENGINEERING
DSI	MFJ	AND MORE...
DENTRON	MIRAGE	* Ask us for details.

**BUSINESSMEN:** Ask about **BARRY'S** line of business-band equipment. *We've got it!*

### Amateur Radio License Classes:

**Wednesday & Thursday: 7-9 pm**  
**Saturday 10 am-Noon**

The Export Experts Invite Overseas orders

¡ AQUÍ SE  
HABLA  
ESPAÑOL !

— We Ship Worldwide

## BARRY ELECTRONICS

512 BROADWAY, NEW YORK, N.Y. 10012

TELEPHONE (212) 925-7000

# appreciating the L matching network

## Theory and application of the L network in Amateur circuits

Often one looks at transmitter schematics and notices the simple two-element networks in the shape of the letter L, which are used to match a source impedance to a load impedance. These seemingly simple devices, which display high efficiencies, often baffle many Amateurs. The thought of using two completely reactive components to transform the value of a resistor by itself seems intriguing. Such simple circuits find their way into almost every piece of communications equipment; matching transistor input and output, matching a reactive antenna to a flat line, and matching a driver stage to a final amplifier. One drawback of the L network is that it is an exact match at only one frequency.

Let's look into the L network to try to understand it better. But we'll try to use less mathematics and more intuition to derive the equations. Once we've done this, we'll then be able to confidently use the networks not only to transform values of purely resistive loads to match a source resistance, but we'll also be able to match any complex impedance as well. The first step in understanding the L network is to

examine the series-to-parallel impedance conversions.

### series-parallel impedance conversions

A series combination of a resistor and an inductor or capacitor may be transformed into an equivalent parallel circuit. If the impedance of two components inside a black box were measured at a single frequency, you would have two answers: a series circuit and its equivalent parallel combination, **fig. 1**.

To understand the series equivalent of a parallel circuit or *vice versa*, begin by writing the simple expression for the impedance across two parallel elements,  $Z_p$ , and later try to shape it into a series circuit.

$$Z_p = \frac{(jX_p)(R_p)}{R_p + jX_p} \quad (1)$$

where  $j$  indicates the imaginary or reactive component ( $j = \sqrt{-1}$ ).

To obtain a real denominator, multiply both numerator and denominator of **eq. 1** by the complex conjugate  $R_p - jX_p$ . The resultant is

$$Z_p = \frac{(jX_p R_p)(R_p - jX_p)}{R_p^2 + X_p^2} \quad (2)$$

where  $j^2 = -1$ .

Next, separate the equation into the real (resistive)

By Ernie Franke, WA2EWT, 63 Hunting Lane,  
Goode, Virginia 24556

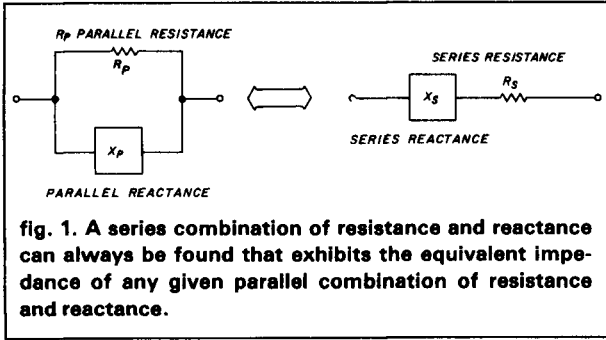

and imaginary (reactive) components by grouping all terms with  $js$  by themselves.

$$Z_p = \left( \frac{X_p^2 R_p}{R_p^2 + X_p^2} \right) + j \left( \frac{X_p R_p^2}{R_p^2 + X_p^2} \right) \quad (3)$$

Thus an equation in the form of a series combination of a real (resistive) component and an imaginary (reactive) component results:

$$Z_s = R_s + jX_s = \text{series equivalent impedance} \quad (4)$$

$$R_s = \frac{X_p^2 R_p}{R_p^2 + X_p^2} = \frac{R_p}{1 + (R_p^2/X_p^2)} \quad (5)$$

$$X_s = \frac{X_p R_p^2}{R_p^2 + X_p^2} = \frac{X_p}{1 + (X_p^2/R_p^2)} \quad (6)$$

If circuit  $Q$  is introduced, the expressions are simplified. The  $Q$  for a parallel circuit is  $R_p/X_p$ , whereas that for a series circuit is  $X_s/R_s$ . Thus, the series equivalent elements are

$$R_s = R_p/(1 + Q^2) \quad (7)$$

$$X_s = X_p/(1 + 1/Q^2) \quad (8)$$

A transformation from a series to the equivalent par-

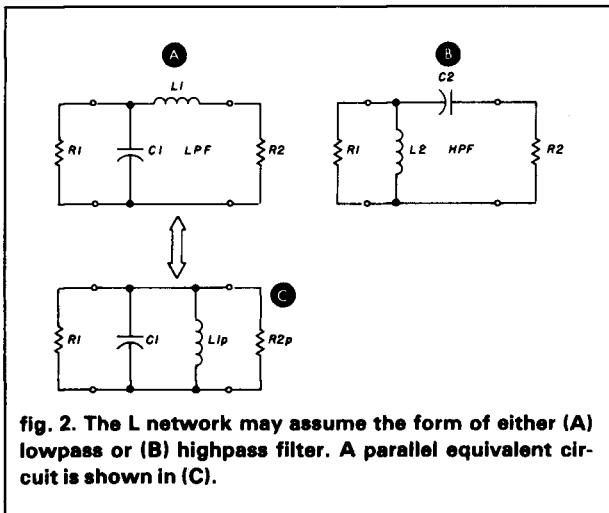

allel circuit can be made similarly:

$$R_p = R_s [1 + (X_s^2/R_s^2)] = R_s(1 + Q^2) \quad (9)$$

$$X_p = X_s [1 + (R_s^2/X_s^2)] = X_s(1 + 1/Q^2) \quad (10)$$

The sign of the reactive component doesn't change; the series equivalent of a parallel capacitance is still a capacitor.

### deriving the L network

Two types of matching L networks are shown in **fig. 2, A and B**. One resistance,  $R1$ , is matched to a smaller resistance,  $R2$ . The shunt element is across the larger resistor, and the series element is connected to the smaller resistance. The method of deriving the equations will be to transform all the elements into the same form and make the reactances cancel.

For the circuit in **fig. 2A**, begin by transforming the series combination of  $L1$  and  $R2$  into a parallel equivalent circuit, which then forms the parallel circuit of  $R1$ ,  $C1$ ,  $L1p$ ,  $R2p$  (**fig. 2C**). The parallel equivalent of  $R2$  is:

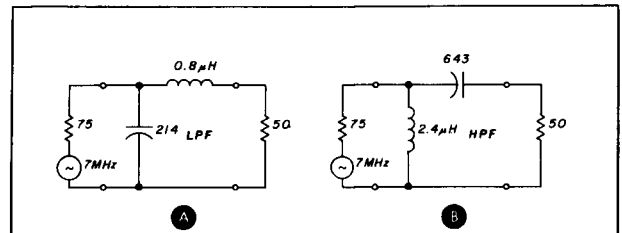

**fig. 3. Components for matching networks using a (A) lowpass filter do not match those of the highpass arrangement, (B).**

$$R_p = R_s [1 + (X_s/R_s)^2] \quad (11)$$

$$R2_p = R2 [1 + (X_{L1}/R2)^2] \quad (12)$$

This transformed value of  $R2$  must equal  $R1$  for impedance matching. If **eq. 12** is solved for  $X_{L1}$  (the inductive reactance of  $L1$ ), substituting  $R1$  for  $R2_p$  in the equation yields

$$X_{L1} = R2 \sqrt{(R1/R2) - 1}; L1 = X_L/2\pi f \quad (13)$$

Thus the value of  $L1$  is based on the resistor ratios. Next transform inductance  $L1$  into its equivalent parallel value:

$$X_p = X_s [1 + (R_s/X_s)^2] \quad (14)$$

$$X_{LP} = X_L [1 + (R2/X_L)^2] \quad (15)$$

$$X_{LP} = R1/\sqrt{(R1/R2) - 1} \quad (16)$$

Now notice that we have a parallel circuit (**fig. 2C**). The transformed parallel inductance,  $X_{LP}$ , can be cancelled by an equal and opposite parallel capacitive reactance:

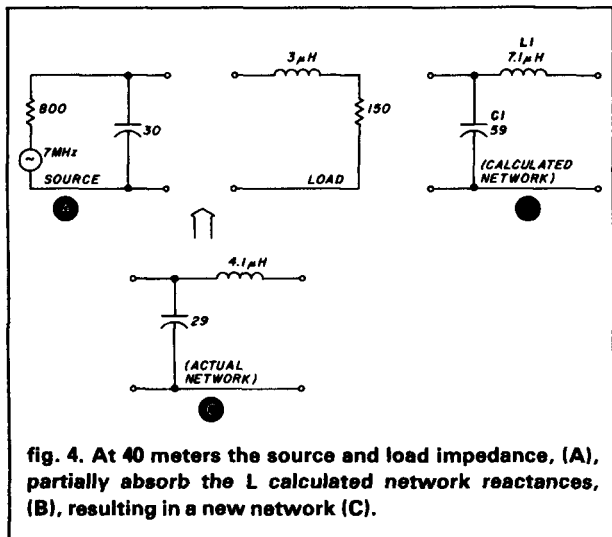

fig. 4. At 40 meters the source and load impedance, (A), partially absorb the L calculated network reactances, (B), resulting in a new network (C).

$$X_{C1} = X_{LP} = R1/\sqrt{(R1/R2)-1};$$

$$C1 = 1/2 \pi f X_C \quad (17)$$

Thus series inductor  $L1$  increased  $R2$  resistance until it matched  $R1$ , then shunt capacitor  $C1$  cancelled the reactance of the inductor, as in a parallel tank circuit. For the network in fig. 2B, simply transform the series arrangement of  $C2$  and  $R2$  into a parallel-equivalent circuit, with the capacitance value determined by the necessary resistance transformation and with inductance  $L2$  of sufficient value to cancel the transformed capacitive reactance.

For each of these networks we could have alternatively transformed the parallel combination on the left into a series-equivalent circuit to match  $R2$  impedance. The value of the other reactance would cancel the series equivalent.

### resistive matching

Now we'll match a resistive generator to a resistive

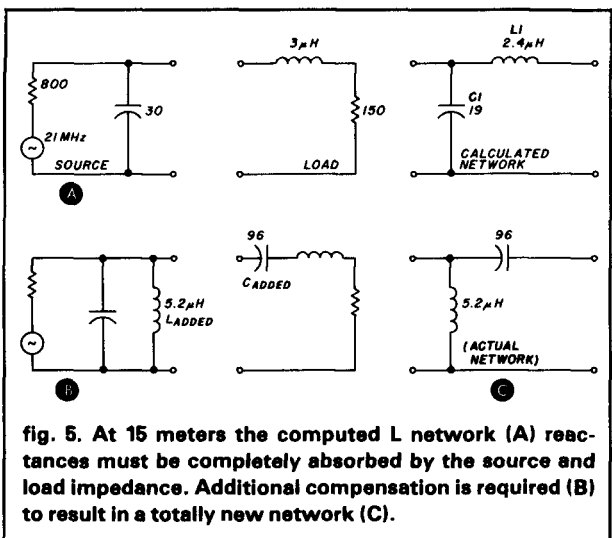

fig. 5. At 15 meters the computed L network (A) reactances must be completely absorbed by the source and load impedance. Additional compensation is required (B) to result in a totally new network (C).

load. An example might be matching a 75-ohm generator, such as the output impedance of an oscillator, to a 50-ohm load (input impedance of a grounded-grid amplifier) on 40 meters. To accomplish this use either configuration fig. 2A or 2B. The larger resistance is always designated  $R1$ .

$$R1 = 75 \text{ ohms}, R2 = 50 \text{ ohms}, f = 7 \text{ MHz}$$

Network 2A:

$$X_{L1} = R2\sqrt{(R1/R2)-1} = 50\sqrt{(75/50)-1} = 35.3 \text{ ohms}$$

$$L1 = X_{L1}/2\pi f = 0.8 \mu\text{H}$$

$$X_{C1} = R1/\sqrt{(R1/R2)-1} = 75/\sqrt{(75/50)-1} = 106 \text{ ohms}$$

$$C1 = 1/2\pi f X_{C1} = 214 \text{ pF}$$

Network 2B:

$$X_{L2} = R1/\sqrt{(R1/R2)-1} = 75/\sqrt{(75/50)-1} = 106 \text{ ohms}$$

$$L2 = X_{L2}/2\pi f = 2.41 \mu\text{H}$$

$$X_{C2} = R2\sqrt{(R1/R2)-1} = 50\sqrt{(75/50)-1} = 35.3 \text{ ohms}$$

$$C2 = 1/2\pi f X_{C2} = 643 \text{ pF}$$

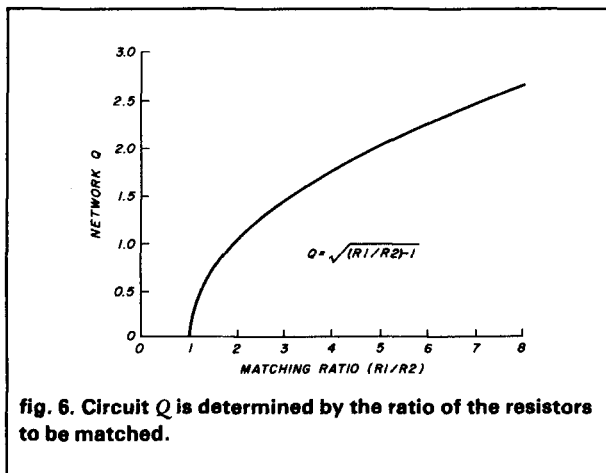

fig. 6. Circuit Q is determined by the ratio of the resistors to be matched.

Thus the same impedances can be matched with two different sets of components, fig. 3.

The principal difference between networks 2A and 2B (fig. 2) is that network 2A is a lowpass filter and network 2B is a highpass filter. For most applications it's desirable to suppress harmonics; thus network 2A is chosen. It turns out that network 2A is also easier to construct, because one end of a variable capacitor can be physically grounded to decrease lead inductance.

### complex impedance matching

Now that we can match one resistor to another, we'll try to match complex impedances. Begin by designing an L network for matching the resistive part of a source to the resistive part of the load, then

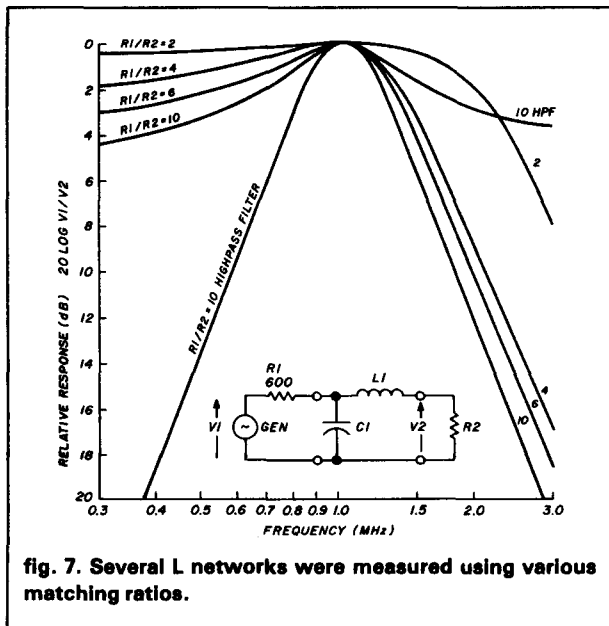

modify the component values of the L network to take into account the reactive parts of source and load. Here's an example using network 2A, because we want to suppress harmonics.

**40-meter-band example.** Decide whether the source resistance is higher or lower than the load resistance. The higher resistance is labelled R1. Let's match a 40-meter final amplifier, which has a plate resistance of 800 ohms with a shunt capacitance of 30 pF, to a 150-ohm load with a series inductance of 3 μH, fig. 4A.

$$R1 = 800 \text{ ohms}, R2 = 150 \text{ ohms}, f = 7 \text{ MHz}$$

Use the equations for network 2A, which states:

$$X_{L1} = R2\sqrt{(R1/R2)-1} = 312 \text{ ohms}$$

$$L1 = X_{L1}/2\pi f = 7.1 \mu\text{H}$$

$$X_{C1} = R1/\sqrt{(R1/R2)-1} = 384 \text{ ohms}$$

$$C1 = 1/2\pi f X_{C1} = 59 \text{ pF}$$

If this network, fig. 4B, is inserted between the two resistances, we would have matched the resistances at 7 MHz. Note, however, that we must also compensate for the source shunt capacitance and the load series inductance. First, capacitance C1 of the matching network is in parallel with the source shunt capacitance. Therefore, C1 must be equal to 29 pF. The remaining 30 pF required for matching is already present in the source shunt capacitance. The same thing can be done with the load impedance. Instead of adding a 7.1-μH inductor as calculated, use the 3-μH inductance present in the load and add 4.1 μH to make up the difference, fig. 4C.

**15-meter-band example.** The previous example was easy in that the source and load impedances turned out to be directly absorbed into the matching network. What if we wanted to match the same load and source on a different band, say 15 meters?

Using the same equations at the new frequency, fig. 5A,  $f = 21 \text{ MHz}$ ,  $C1 = 19 \text{ pF}$ ,  $L1 = 2.4 \mu\text{H}$ , the value of C1 will be totally absorbed into the source shunt capacitance with 11 pF left over, which must be cancelled. An inductor could be inserted across the source shunt capacitance to cancel only 11 pF of capacitance, fig. 5B. The inductive reactance of the added coil must equal the capacitive reactance of the excess shunt capacitance:

$$\begin{aligned} X_{L(\text{added})} &= X_{C(\text{excess})} = 1/(2\pi f_{\text{excess}}) \\ &= 1/[2\pi f(30\text{pF} - 19\text{pF})] \\ &= 1/(6.28)(21\text{MHz})(11\text{pF}) \\ &= 688 \text{ ohms} \end{aligned}$$

$$\begin{aligned} L_{\text{added}} &= [X_{L(\text{added})}/2\pi f] \\ &= 688/2\pi f \\ &= 5.2 \mu\text{H} \end{aligned}$$

The amazing thing is that, when we build the matching L network, instead of a shunt capacitance, C1, we'll actually have a shunt inductance, Ladded, fig. 5C.

Now for matching the load impedance. The load already has 3 μH of inductance, which is greater than the 2.4-μH series inductance required, leaving an excess of 0.6 μH to be cancelled. A series-capacitive reactance, just large enough to cancel the 0.6 μH of excess inductance, is needed (fig. 5B).

$$X_{L(\text{excess})} = 2\pi f L(\text{excess}) = 2\pi f(0.6\mu\text{H}) = 79 \text{ ohms}$$

$$C(\text{added}) = 1/2\pi f X_{L(\text{excess})} = 96 \text{ pF}$$

The L network, fig. 5C, looks more like the high-

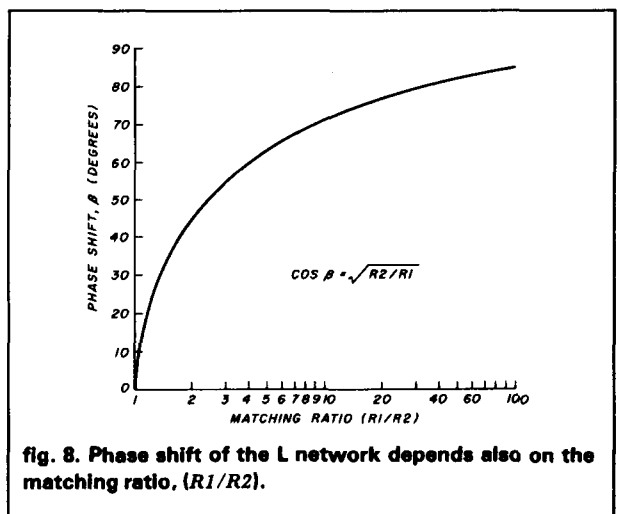

pass filter shown in **fig. 2B** than what we started out to make. Our new filter merely subtracts enough reactance so that the inherent reactance remaining in the source and load perform the actual matching. The total effect is, however, basically that of a low-pass filter.

The only problem now remaining in applying the L network to any impedance is that source and load might not be in the right form. What is needed is for the impedance on the shunt side of the L network to be described in a parallel or shunt form, and that on the series side to be described in a series configuration. If this is not the case, the impedances must be converted using the series-parallel conversion rules discussed earlier. Once this is done source and load reactances can be easily cancelled.

### bandwidth

The  $Q$  or quality factor of the matching network determines the bandwidth between the upper ( $f_1$ ) and lower ( $f_2$ ) 3-dB frequencies.

$$Q = \frac{f_0}{f_1 - f_2} = \frac{\text{operating frequency}}{\text{bandwidth}} \quad (18)$$

The  $Q$  for an L matching network is:

$$Q = \sqrt{(R1/R2) - 1} \text{ as shown in fig. 6.}$$

Thus  $Q$ , or selectivity, is determined by the ratio of the impedances to be matched and cannot be selected independently, as in the more complex  $\pi$  and  $T$  matching networks. As the matching ratio increases, so does the circuit  $Q$ . The efficiency of an L network is usually greater than 95 per cent:

$$\text{efficiency} = [R2/(R2 + R_{coil})] [100] \quad (19)$$

### some experiments

I put a few L networks together and measured them to see what they could do, **fig. 7**. I decided to match a 600-ohm generator to various loads at 1 MHz. How the  $Q$  affects attenuation at the second and third harmonics is apparent. For a matching ratio greater than 4 ( $Q$  of 1.7), the slope of the attenuation quickly approaches 12-dB/octave. Every time the frequency is doubled, attenuation increases by 12 dB. The series inductor contributes 6-dB/octave, while the shunt capacitor completes the additional 6 dB. Thus you can expect about 12 dB of attenuation at the second harmonic and 19 dB at the third. I also compared the response of an L network for a matching ratio of 10:1 using either the highpass or lowpass version of the L network. They appear symmetrical about the center frequency.

The ability of an L network to match impedances is also limited by the characteristics of the components. As the frequency is sufficiently increased, the

series inductance in the leads of a capacitor predominate, making it look more like an inductor than a capacitor. The same thing happens to inductors at high frequencies, with the capacitance between coil windings tending to shunt the effects of inductance.

The phase shift,  $\beta$ , for an L network as shown in **fig. 8A** is:

$$\cos \beta = \sqrt{R2/R1} \quad (20)$$

when  $\beta$  is measured in degrees, as shown in **fig. 8**. The lagging phase shift approaches 90 per cent as the matching ratio exceeds 10:1. As the matching ratio is increased, the necessary shunt capacitance,  $C1$ , and series inductance,  $L1$ , decrease for a constant input impedance. Therefore, as the matching ratio increases, the network behaves more like a capacitor. This phase delay must be taken into account when matching into different elements of a phased array antenna.

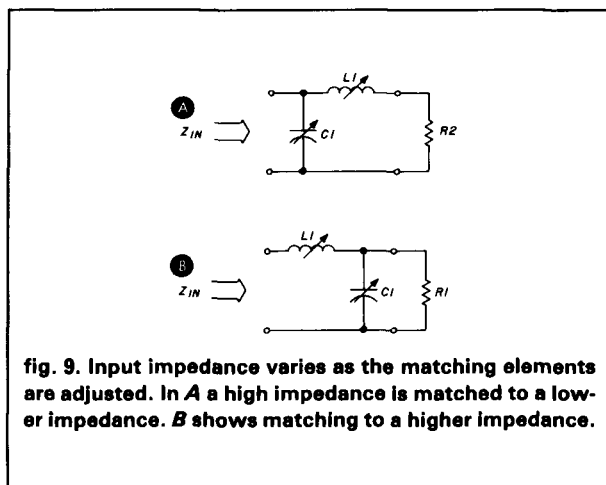

Finally, let's take a brief look at the input impedance of an L network as series inductor,  $L1$ , and shunt capacitor,  $C1$ , are varied. For the case of matching a high impedance downward, **fig. 9A**, note that the real part of the transformation is controlled mostly by varying series inductor  $L1$ . Remember that matching circuits have been designed for the resistance ratio, then modified slightly to remove reactances. Increasing  $L1$  increases the real part of the input impedance. The value of shunt capacitance  $C1$  controls the reactive part of the impedance presented to the input. Increasing capacitance increases the  $-j$  term.

For the case of matching to a higher impedance, **fig. 9B**, decreasing  $C1$  causes the real part of the input impedance to increase. Increasing  $L1$  makes the input impedance appear more inductive.

**ham radio**



# ALPHA

Next best isn't even close.

Like the Royal Gorge bridge at Canon City—the world's highest, suspended 1053 feet above the Arkansas River—an **ALPHA** hf linear amplifier is in a class by itself. Whatever's "next best" isn't even close!

A "next best" amplifier CAN'T give you **No Tune Up** convenience with maximum legal power in all modes. ONLY **ALPHA 374A** AND **ALPHA 78** CAN.

"Next best" can't deliver full CW break-in capability AND maximum legal power in all modes, either. ONLY **ALPHA 77Dx** AND **ALPHA 78** CAN.

Nor will "next best" provide you the protection of a TWO YEAR (limited) FACTORY WARRANTY for amateur service, or an unequivocal "key-down-no-time-limit" full kilowatt power rating. You'd probably have to settle for 90 days and an ambiguous reference to "continuous duty". BUT YOU GET THAT WARRANTY AND RATING WITH EVERY **ALPHA**!

**IF NEXT BEST ISN'T GOOD ENOUGH FOR YOU, ALPHA IS THE ANSWER.**



## RF TECHNICIANS AND ENGINEERS!

ETO offers an exceptional opportunity to work on exciting new projects while enjoying life in "the garden spot of the Rockies." We need a few self-starters with proven ability and hands-on rf/hf power experience to develop and produce new equipment for existing medical, communications, and industrial/

scientific applications. Please send resume.  
**ETO**  
EHRHORN TECHNOLOGICAL  
OPERATIONS, INC.  
P.O. BOX 708, CANON CITY, CO 81212  
(303) 275-1613

# the half-wave balun: theory and application

## Some notes on this versatile tool for impedance matching

The half-wave balun, in which the inverted portion of the balanced output signal is obtained by using a half-wave section of transmission line, is perhaps the simplest and most economical balun available; because of this simplicity and low cost, it's one of the most popular. Its design is straightforward — so simple, in fact, that equations are hardly necessary. Just measure a half wavelength of transmission line and you have a balun.

Despite the popularity of this type of balun, equations that predict its *performance* are generally unavailable. The only previous work on this type of balun of which I am aware was done by Woodward.<sup>1,2</sup>

The usual schematic of the half-wave balun is given in fig. 1. For analysis it's convenient to redraw fig. 1 as shown in fig. 2.

The balanced load is assumed to be perfectly balanced; admittedly this isn't always true in practice, but it would not be fair to blame the balun for imperfections caused by the load. The impedance seen by the generator at the unbalanced port is  $Z_L/2$  in parallel with  $Z_L/2$ , or  $Z_L/4$ , as expected.

In most baluns, the two most important characteristics are the impedance match and the degree of balance, both versus frequency.

### impedance balance

One desirable characteristic of a balun is that it presents an essentially constant impedance over a wide bandwidth. Since the half-wave balun will be

exactly one-half wavelength at only one frequency, it's useful to examine the impedance presented to the generator in fig. 2. The input impedance in fig. 2 is composed of one-half the load impedance,  $Z_L$ , in parallel with the input impedance of the half-wave balancing line. This line, in turn, is terminated in the other half of the load impedance,  $Z_2$ . The impedances  $Z_L$  and  $Z_2$  will both be assumed to be independent of frequency. The input impedance of the balancing line, however, will depend on the characteristic impedance and the electrical length of the line, and hence on frequency.

The impedance presented at the input of the half-wave balancing line is given by the familiar transmission line equation:

$$Z_{in} = Z_c \left[ \frac{Z_2 \cos \theta + jZ_c \sin \theta}{Z_c \cos \theta + jZ_2 \sin \theta} \right] \quad (1)$$

where  $Z_{in}$  = input impedance of half-wave balancing line

$Z_c$  = characteristic impedance of balancing line

$Z_2$  = load impedance of the balun; equal to one-half balanced load

After some arithmetical manipulation, which I'll explain in the appendix, and setting  $k = Z_c/Z_2$ , we obtain the ratio of input impedance to load impedance for the resistive (real) component:

$$\frac{Z_{in}}{Z_c} = \frac{k^2}{(k \cos \theta)^2 + (\sin \theta)^2} \quad (2)$$

Eq. 2 is plotted for various values of  $k$  over a range of  $\theta$  from 90 to 270 degrees; see fig. 3. This represents a frequency range from one-half to one and one-half times the design frequency. The ordinate gives the input impedance in terms of the load impedance.

As shown, the ordinate is matched ( $Z_{in} = Z_c$ ) for all values of characteristic impedance only when  $k = 1$ , i.e., when the characteristic impedance equals the load impedance. If you stop and think about it, both these results should have been expected.

For values of  $\theta = 90$  and  $270$  degrees, the balanc-

This article was originally published in the December 6, 1979, issue of *Electronic Design* and is republished here with the permission of the author.

By John J. Nagle, K4KJ, 12330 Lawyers Road, Herndon, Virginia 22071

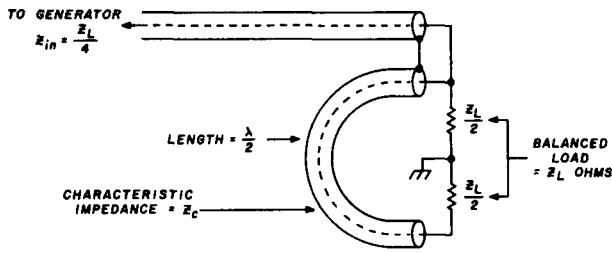

fig. 1. Basic half-wave balun circuit using lengths of transmission line.

ing line is an odd number of quarter-wavelengths; thus the balancing line inverts the load impedance about the characteristic impedance squared. For these line lengths, the ratio  $Z_{in}/Z_2$  is equal to  $k^2$ .

Fig. 4 shows the reactive (imaginary) component of balancing line input impedance. In this case the reactance is zero for all frequencies only when  $k = 1$ , again the matched case.

The balun input impedance is, of course, the impedance given from figs. 3 and 4 in parallel with  $Z_1 = (Z_L/2)$ . (This latter impedance has been assumed to be independent of frequency, but in the real world it may also vary with frequency.)

### balance bandwidth

In addition to the impedance bandwidth, it's desirable to know balance bandwidth. Balance bandwidth means that the frequency range over which the currents through the two halves of the balanced load are equal in magnitude and opposite in phase with a specified tolerance. Following Woodward,<sup>1,2</sup> we use as the criteria of balance:

$$\text{balance} = \left| \frac{I_1 - I_2}{I_1 + I_2} \right| \quad (3)$$

From fig. 2 current  $I_1$  is given by  $\frac{e_0}{Z_1}$ . Current  $I_2$  is given in terms of the load resistance and characteristic impedance by the well-known transmission line equation<sup>3</sup>

$$e_0 = e_2 \cos \theta - jI_2 Z_c \sin \theta \quad (4)$$

After arithmetical manipulations as shown in the appendix, we obtain:

$$I_2 = \frac{e_0}{Z_2 (\cos \theta + jk \sin \theta)} \quad (5)$$

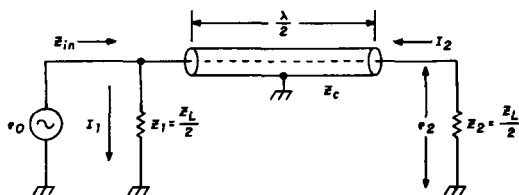

fig. 2. Equivalent of half-wave balun shown in fig. 1.

$$\text{from which } \left| \frac{I_1 - I_2}{I_1 + I_2} \right| = \left| \frac{(\cos \theta + 1) + jk \sin \theta}{(\cos \theta - 1) + jk \sin \theta} \right| \quad (6)$$

where  $k = \frac{Z_c}{Z_2}$  as before.

After rationalizing, separating into real and imaginary parts, and finding the magnitude (described in the appendix), a plot of this equation is given in fig. 5; the system is balanced when the plot equals zero. As can be seen, a perfect balance occurs only when  $\theta = 180$  degrees as might be expected. The balance bandwidth improves for small values of  $k = Z_c/Z_2$ . Thus, for best balance bandwidth, the load impedance should be large compared with the balancing-line characteristic impedance. This is contrary to impedance bandwidth considerations, in which the widest impedance bandwidth is obtained for the matched case.

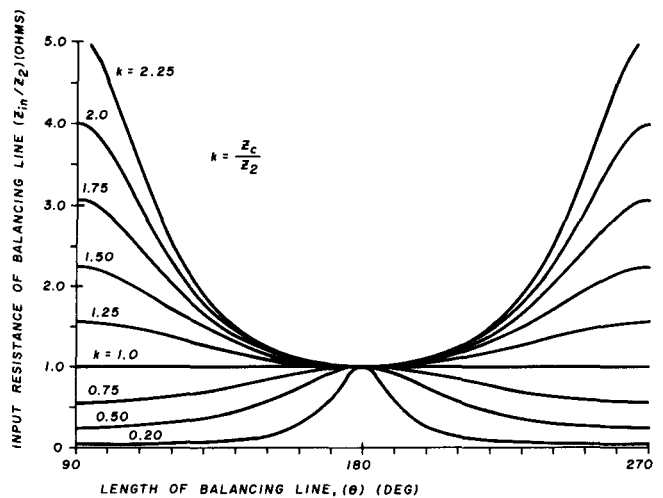

fig. 3. Input resistance of the half-wave balancing line as a function of line length for various values of characteristic impedance.

Increasing the load impedance to values greater than about ten times the characteristic impedance ( $k \leq 0.1$ ) gives little additional improvement in balance bandwidth. For small values of  $k$ , eq. 6 approaches  $(\cos \theta + 1)/(\cos \theta - 1)$ , which is independent of  $k$ .

### phase shift

One final factor to consider is the change in phase with frequency caused by propagation delay through the balancing line. At the design frequency, the relative phase at the output of the line is 180 degrees with respect to the input. This phase shift will vary directly with frequency. Assuming that the amplitude (current or voltage) is constant with frequency, the phase change will cause reduction in the in-phase component (referenced to 180-degree phase-shift

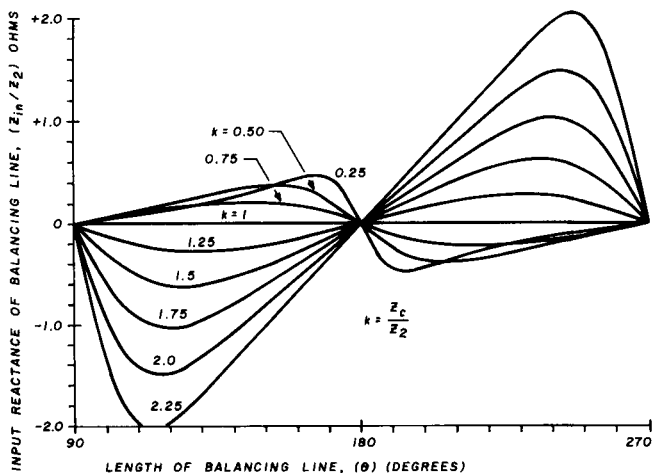

fig. 4. Input reactance of the half-wave balun as a function of line length for various values of characteristic impedance.

from the balancing-cable input) and the generation of a quadrature component.

The in-phase and quadrature components will be proportional to

$$\cos \theta \text{ (in-phase) and } \sin \theta \text{ (quadrature)} \quad (7)$$

respectively, where  $\theta$  is the deviation from 180 degrees with respect to the input. From eq. 7, it can be seen that a deviation of 26 degrees (14.5 per cent) of design frequency will cause a 1-dB reduction in output amplitude through one-half of the balanced load caused by phase change. Similarly, a 6.24 degree deviation (3.4 per cent of design frequency) will cause a 1-dB quadrature component to be generated.

The effect of the reduction in the in-phase component is an unbalance through one-half the load. The effect of the quadrature component will depend upon the balanced-load characteristics. If the balanced load is an antenna, two possibilities are a) generation of unexpected side lobes, or b) generation of a circular component to the antenna response.

In other situations the quadrature component may or may not be important. The effect of the quadrature component should be considered for each application.

### example

A typical application of the half-wave balun is to couple a balanced folded dipole with a nominal impedance of 300 ohms to a 75-ohm coaxial cable. This represents a 4:1 impedance transformation. For convenience, the same 75-ohm coax is generally also used for the balancing section. In this case,  $Z_2 = Z_1 = 150 \text{ ohms}$  equals one-half the balanced load, so that with 75-ohm coax,  $k = 75/150 = 0.5$ . From the

$k = 0.5$  curve, it can be seen that the frequency range is not particularly good — only about  $\pm 25$  degrees or about 12 per cent for an impedance change to the 70 per cent point. Use of higher-impedance coax for the balancing section would give a wider bandwidth.

It can also be seen that the half-wave balun will give better performance when used to couple a circuit to a higher impedance balanced load, such as a folded dipole, rather than to a lower impedance antenna, such as a Yagi antenna.

### conclusions

I have discussed the performance of the half-wave coaxial balun. As often occurs in engineering problems, the performance characteristics of a device can have very subtle implications, even when the device itself is extremely simple. It has been shown that the best impedance characteristic is obtained when the impedance of the balancing line is equal to one-half the balanced load impedance. On the other hand, the best balance versus frequency characteristic is obtained when the balanced load impedance is high compared with the balancing line impedance. There is no requirement that the characteristic impedance of the transmission line feeding the balun/load be the same as that of the balancing half-wave section.

Whether or not the bandwidth limitations of the half-wave balun are the limiting factor in overall system performance depends on other factors. In particular, if the balanced load is an antenna, as it often is, its performance may deteriorate faster than that of the balun so that it may be the limiting factor.

Despite the bandwidth limitations described, I believe the half-wave balun will continue to be widely used because of its simplicity and economy.

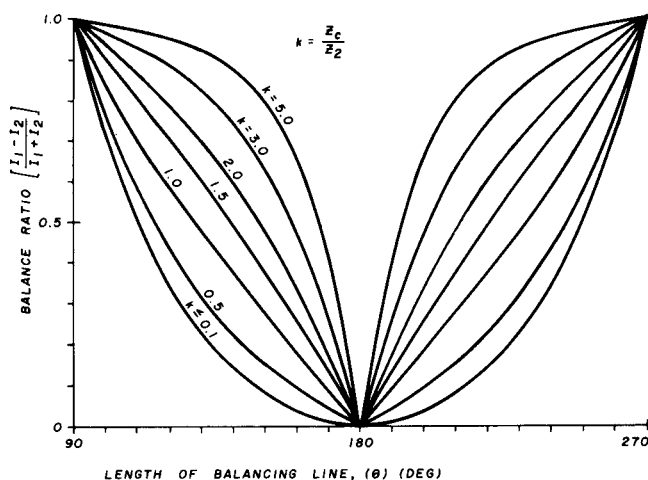

fig. 5. Balance ratio as a function of balancing-line electrical length. Perfect balance is obtained when the balance ratio is zero.

## references

1. O.M. Woodward, Jr., "Balance Measurements on Balun Transformers," *RCA License Bulletin LB-872*, July 22, 1952. RCA Laboratories Division, Princeton, New Jersey.
2. O.M. Woodward, Jr., "Balance Measurements on Balun Transformers," *Electronics*, Vol. 26, No. 9, September, 1953, pages 188-191.
3. Terman, *Radio Engineering*, 3rd Edition, McGraw-Hill Book Company, Inc., 1947, figure 4-1, page 75, and Eq. (4-32a), page 92.

## appendix

Because many of *ham radio's* readers are mathematically inclined, I'll present a brief derivation of the more important equations used in this article.

Beginning with the basic transmission line equation, eq. 1, divide the numerator and denominator of the right-hand side by  $Z_2$ ; also divide both sides of the equation by  $Z_2$ . This gives:

$$\frac{Z_{in}}{Z_2} = \frac{Z_c}{Z_2} \left[ \frac{\cos \theta + j \frac{Z_c}{Z_2} \sin \theta}{\frac{Z_c}{Z_2} \cos \theta + j \sin \theta} \right] \quad (\text{A-1})$$

$$= k \left[ \frac{\cos \theta + j k \sin \theta}{k \cos \theta + j \sin \theta} \right] \quad (\text{A-2})$$

Since we defined  $\frac{Z_c}{Z_2} = k$

Now rationalize eq. A-2.

$$\frac{Z_{in}}{Z_2} = k \left[ \frac{\cos \theta + j k \sin \theta}{k \cos \theta + j \sin \theta} \right] \left[ \frac{k \cos \theta - j \sin \theta}{k \cos \theta - j \sin \theta} \right] \quad (\text{A-3})$$

Separate eq. A-3 into real and imaginary parts:

$$\begin{aligned} \frac{Z_{in}}{Z_2} (\text{real}) &= k \left[ \frac{k \cos^2 \theta + k \sin^2 \theta}{(k \cos \theta)^2 + (\sin \theta)^2} \right] \\ &= \frac{k^2}{(k \cos \theta)^2 + (\sin \theta)^2} \end{aligned} \quad (\text{A-4})$$

which is plotted in fig. 3.

Note that when  $k = 1$ , the matched case,  $\frac{Z_{in}}{Z_2}$  (real) is independent of  $\theta$  and equal to unity.

For the imaginary part,

$$\frac{Z_{in}}{Z_2} (\text{imag.}) = k \left[ \frac{k^2 \cos \theta \sin \theta - \cos \theta \sin \theta}{(k \cos \theta)^2 + (\sin \theta)^2} \right]$$

Factoring,

$$\frac{Z_{in}}{Z_2} (\text{imag.}) = k \left[ \frac{(k^2 - 1) \cos \theta \sin \theta}{(k \cos \theta)^2 + (\sin \theta)^2} \right] \quad (\text{A-5})$$

which is plotted in fig. 4.

In this case, when  $k = 1$ , the imag. part of  $\frac{Z_{in}}{Z_2}$ , which represents the reactive component, is zero regardless of  $\theta$ .

To derive the balance equation, eq. 6, refer to fig. A-1. From fig. A-1, the well-known transmission line equation can be obtained:<sup>3</sup>

$$E = E_r \cos \theta + jI_r Z_0 \sin \theta \quad (\text{A-6})$$

Eq. A-6 gives voltage at the input of the transmission line in terms of the load current and characteristic impedance of the line.

As  $E_r = I_r Z_r$ , eq. A-6 can be rewritten as

$$E = I_r Z_r \cos \theta + jI_r Z_0 \sin \theta \quad (\text{A-7})$$

Solving for  $I_r$ ,

$$I_r = \frac{E}{Z_r \cos \theta + jZ_0 \sin \theta} \quad (\text{A-8})$$

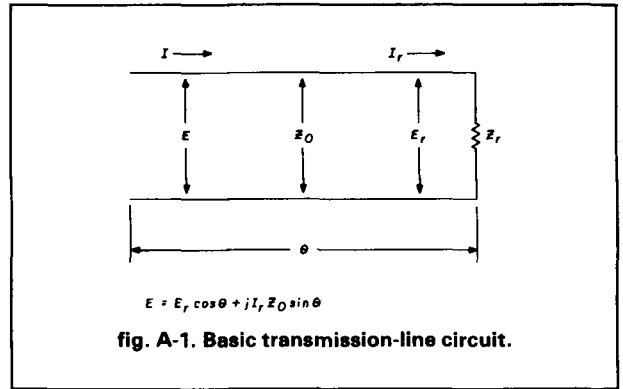

Rewrite eq. A-8 using the nomenclature of fig. 2:

$$I_2 = \frac{-e_0}{Z_2 \cos \theta + jZ_c \sin \theta} \quad (\text{A-9})$$

The minus sign is obtained since  $I_2$  of fig. 2 flows in the opposite direction from  $I_r$ .

Since  $k = \frac{Z_c}{Z_2}$ ,

$$I_2 = \frac{-e_0}{Z_2 (\cos \theta + j k \sin \theta)}$$

which is eq. 5 in text.

Current  $I_1$  in fig. 2 is given by  $I_1 = \frac{e_0}{Z_1}$ . But since  $Z_1 = Z_2$ , we can write  $I_1 = \frac{e_0}{Z_2}$ . Hence the ratio  $\left| \frac{I_1 - I_2}{I_1 + I_2} \right|$  is given by

$$\begin{aligned} |\text{ratio}| &= \left| \frac{\frac{e_0}{Z_2} - \frac{-e_0}{Z_2 (\cos \theta + j k \sin \theta)}}{\frac{e_0}{Z_2} + \frac{-e_0}{Z_2 (\cos \theta + j k \sin \theta)}} \right| \\ |\text{ratio}| &= \left| \frac{(\cos \theta + 1) + j k \sin \theta}{(\cos \theta - 1) + j k \sin \theta} \right| \end{aligned} \quad (\text{A-10})$$

Rationalize eq. A-10 and obtain

$$|\text{ratio}| = \frac{[(\cos \theta + 1) + j k \sin \theta][(\cos \theta - 1) - j k \sin \theta]}{(\cos \theta - 1)^2 + (k \sin \theta)^2}$$

from which the real and imaginary parts are given by

$$\text{real} = \frac{\cos^2 \theta - 1 + (k \sin \theta)^2}{(\cos \theta - 1)^2 + (k \sin \theta)^2}$$

$$\text{imaginary} = \frac{-2k \sin \theta}{(\cos \theta - 1)^2 + (k \sin \theta)^2}$$

The magnitude is given by the square root of the sum of the real and imaginary parts squared, or

$$\text{magnitude} = \frac{\sqrt{[\cos^2 \theta - 1 + k^2 \sin^2 \theta]^2 + [-2k \sin \theta]^2}}{(\cos \theta - 1)^2 + (k \sin \theta)^2} \quad (\text{A-11})$$

This equation is plotted in fig. 5. It can be seen from eq. A-11 that when  $k \leq 0.1$ , the magnitude approaches

$$\text{magnitude} = \left| \frac{\cos \theta + 1}{\cos \theta - 1} \right|$$

and is independent of  $k$ .

ham radio

ATTENTION IC-2A OWNERS:

# IC-2A TONE DECKS ARE HERE!

CUSTOM DESIGNED TO FIT WITH NO TROUBLE!

## IT'S HERE NOW!

The question used to be, "When is Icom coming out with a hand-held?"...Now that it's become one of the hottest two meter rigs around, the big question now is, "When will a sub-audible tone option be available for my IC-2A?" The answer is: Spectronics has it now!



## FULLY TUNABLE!

We are proud to be first in offering you a fully tunable miniature sub-audible tone deck specifically designed to fit the Icom IC-2A hand-held transceiver. If you own one of the other synthesized hand helds, you'll be delighted to know that you can put it in your unit as well.



## QUALITY TO LAST!

This unit is manufactured by Transcom, Inc., to their exacting standards and is guaranteed to be stable to within  $\pm .1$  Hz, after proper tuning. All units are pre-set to your specified tone, and require no further adjustment for frequency.

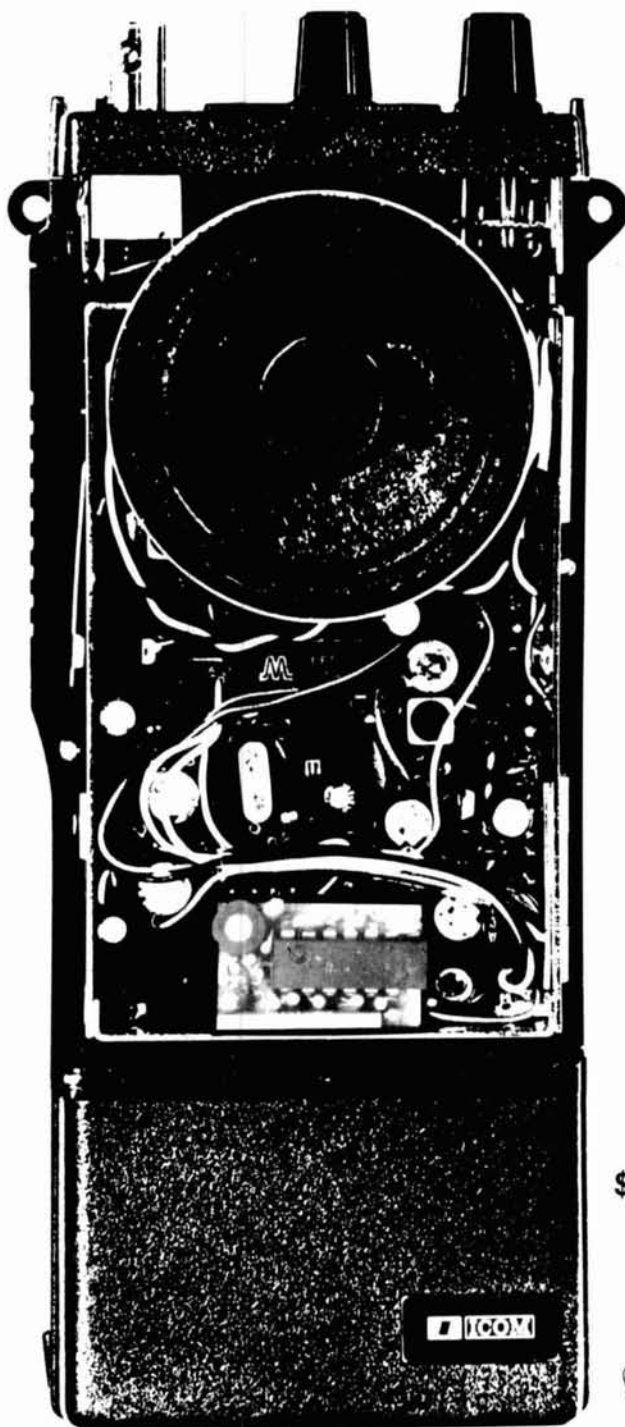

## ANOTHER SPECTRONICS FIRST!



## TOP VIEW



## SIDE VIEW

- Fits plain or TT.
- Fully tunable! No tone elements to buy - ever!
- Also fits other synthesized hand-helds as well.
- Easy to install; no cutting, chopping, or remote parts!
- Accurate to  $\pm .1$  Hz.

\$ **29**<sup>95</sup> Plus \$2.00 S & H



PHONE: (312) 848-6777



**SPECTRONICS, INC.** — 1009 GARFIELD ST. OAK PARK, ILL. 60304

# Yagi antenna design: quads and quagis

A discussion  
of the  
one wavelength  
in circumference loop  
including examination  
of gain and loop shape

Up to this point in this series on Yagi antennas, we have considered only linear cylindrical elements about one-half wavelength long with a small diameter compared to wavelength; there is in common use, however, a radiating "element" consisting of a loop of wire about one wavelength in circumference. There are many such loop configurations: a triangular loop (commonly known as a delta loop), a square loop with two sides parallel to the earth (known as the quad), and a square loop oriented so that two diagonal corners are perpendicular to the earth (known as a diamond loop). Loops can also be made that are not equilateral. Triangles can be isosceles or even with three different sides; four-sided loops can be rectangles, and, indeed, loops can have more than four sides or can even be round.

The one-wavelength loop can be used either as a driven radiator or a parasite. To drive the loop it is opened at some point on its circumference where it is excited with a suitable voltage or current. As a parasite the loop is left closed; current will flow depending upon the induced voltages from other loops or elements and the self-impedance of the loop. To help understand the behavior of these loops it is useful to model the loop in terms of dipole elements.

Let's first consider a model for a square quad driven loop. The model starts with two driven half-wavelength dipoles in free space as shown in **fig. 1**. The dipoles are voltage driven at their centers (at  $xx$  and  $yy$ ) and in this model are separated (vertically) by a quarter wavelength ( $\lambda/4$ ). If the excitation is equal at  $xx$  and  $yy$  (the same voltage and phase), the dipole currents will also be equal and, therefore, the voltages at the ends of the dipoles will be equal. The outer  $\lambda/8$  sections of each dipole may now be bent as shown by the dotted line, forming a square. Since the voltages at dipole ends are still equal, the bent dipoles can be connected together without changing any currents in the square.

Since for each dipole there is a unique relationship between voltage at its ends to current at its center, the end connection of both dipoles in the square configuration insures that the center dipole currents will be equal even though excitation voltages at  $xx$  and  $yy$  may be different! Indeed, we can remove voltage excitation at  $yy$  (shorting the terminals) and still be sure that whatever dipole currents flow from excitation at  $xx$ , they will be equal in the two dipoles. One can look at the excitation in this case as a dipole *current* feed at  $xx$ ; the dipole centered at  $yy$  is *voltage* fed at its ends. Note that to realize the same loop current the sum of the voltages supplied to  $xx$  and  $yy$  must be constant. This leads to the well-known fact that the driving point impedance at  $xx$  and  $yy$  shorted will be just twice the impedance at  $xx$  when  $yy$  and  $xx$  are excited equally.

**Fig. 2** shows the square quad excited at the center of the bottom section and also shows the relative magnitudes and directions of the currents which flow. Note that the horizontal sections of the square show currents in the same direction as those of the original dipoles of **fig. 1**; therefore these sections will provide radiation fields at long distances; since they are shorter than the original half-wavelength dipoles,

By James L. Lawson, W2PV, 2532 Troy Road,  
Schenectady, New York 12309

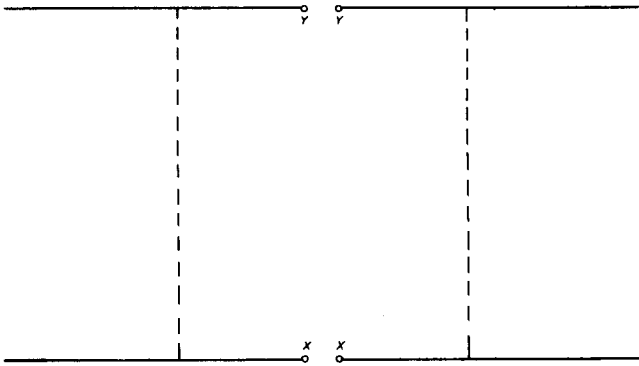

fig. 1. Diagram of two driven dipoles with  $\lambda/4$  vertical spacing. Bending the ends of the dipoles together, as shown by the dotted lines, forms the square quad loop.

however, they require more current to produce a given radiation field, *i.e.*, the radiation resistance will drop. Moreover, the directivity and gain of each segment will be somewhat smaller than that of a full half-wavelength dipole. Both of these effects will be discussed shortly.

The vertical portions of the square quad shown in fig. 2 are quite different. Note that for each of these vertical segments the top and bottom portions have identical currents but in opposite directions. This symmetry insures complete cancellation of the far (radiation) field. In other words, the vertical sections do not radiate; they simply act as a capacitive "top hat" loading (or tuning) for the horizontal radiating segments. Thus the radiating properties of the quad square of fig. 2 will be identical to the (capacity loaded) resonant shortened or truncated horizontal segments alone. These will, of course, produce only horizontally polarized radiation.

Take another look at the two half-wavelength dipoles of fig. 1. The two (broadside) dipoles separated by a distance of  $\lambda/4$  will produce a gain increase over one dipole. This separation or *stacking* gain can be easily calculated by using known self and mutual impedances; the result is shown in table 1 and also in fig. 3 where the overall gain in dBi is plotted against the separation,  $S$ , in units of wavelength,  $\lambda$ . Note that the separation gain improvement peaks when  $S$  is about  $5\lambda/8$ , leading to the often-quoted (but generally incorrect for other than single elements) "optimum stacking separation."

Fig. 3 can be understood qualitatively by remembering that the effective capture cross section area for a single half-wavelength dipole is about  $0.13\lambda^2$ . Thus, when the separation between the dipoles is large enough, the capture areas are basically independent (and thus additive), leading to an effective gain improvement of a factor of 2 or 3 dB. For smaller separations, however, the capture areas

overlap. In this overlap region both constructive and destructive interference can occur; for very small separations the combined capture areas reduce to that of a single dipole but for some intermediate regions (such as  $S = 5\lambda/8$ ) constructive interference occurs, making the gain improvement more than a factor of 2. This constructive interference is due to a favorable reduction in the driving point resistance of the dipole, which is a direct result of the behavior of the real part of the mutual impedance of the two dipoles.

Another qualitative way of understanding this entire phenomenon is to view the (transmitting) dipoles as an excitation of a vertical aperture. Broadening this aperture by separating the dipoles is tantamount to narrowing the *H*-plane pattern, which will increase the gain. When the dipole separation becomes large enough, however, the quasi uniform illumination disappears and the vertical aperture acts like two independent (small) apertures giving rise to a diffraction pattern in the *H*-plane with maxima corresponding to a gain improvement of exactly a factor of 2. In any case, the actual calculated values of gain are shown in table 1. Note that for the quarter-wavelength separation of fig. 1 the gain of the stacked dipoles is 3.236 dBi, or just 1.085 dB above that for a single half-wavelength dipole. This gain increase is all due to *beam* pattern narrowing in the *H*-plane; the *E*-plane pattern beamwidth remains the same as that for a single half-wavelength dipole.

The square quad loop of fig. 2 is very similar to the stacked dipoles of fig. 1, but there are two significant changes. Because of the truncated or shortened elements, the driving-point impedances of the elements are reduced and the *E*-plane pattern width is somewhat increased, resulting in a somewhat reduced gain. To calculate these two results I will use the same method outlined by Kraus<sup>1</sup> (page 139-143).

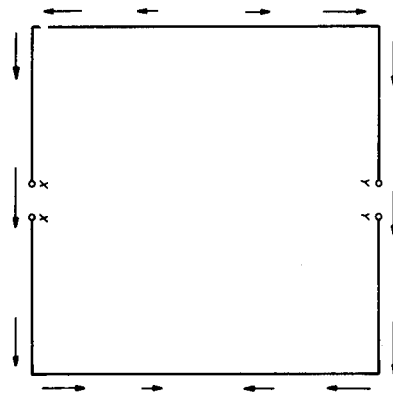

fig. 2. Outline of the square quad loop showing the current distribution in the horizontal and vertical members. Horizontal polarization results with the feedpoints as shown.



Kraus's calculation applies to a thin radiating element which is not capacitance loaded; to make the calculation apply to a single truncated element fed at the maximum current point, the limits of integration must be suitably altered; **fig. 4** shows the essential geometry.

The retarded value of the current at point  $z$  on the antenna referred to a point at distance,  $S$ , is

$$I = I_0 \left[ \cos \frac{2\pi}{\lambda} \cdot z \right] e^{j\omega(t - \frac{S}{c})} \quad (1)$$

where the quantity in brackets is the form factor for the current on the antenna. Following the Kraus development, the antenna can be viewed as a string of infinitesimal dipoles of length  $dz$ . The far fields,  $dE_\theta$  and  $dH_\phi$ , at a distance,  $S$ , from an infinitesimal dipole,  $dz$  are

$$dH_\phi = j \frac{I \sin \theta dz}{S\lambda} \quad (2)$$

$$dE_\theta = 120 \cdot \pi \cdot dH_\phi \quad (3)$$

where  $\phi$  is the azimuth angle around the  $z$  axis. The total field from the entire antenna is then

$$H_\phi = \int_{-L/2}^{+L/2} dH_\phi \quad (4)$$

From **eq. 1**, **eq. 2**, and **eq. 4**,

$$H_\phi = \frac{j I_0 \sin \theta e}{2\lambda} \int_{-L/2}^{+L/2} \frac{1}{S} \cos \frac{2\pi}{\lambda} \cdot z \cdot e^{-j \frac{\omega S}{c}} dz \quad (5)$$

Note that  $S = r - z \cos \theta$  **(6)**

and also note that at long distances the amplitude of  $S$  is the same as the amplitude of  $r$ , so that we may write:

$$H_\phi = \frac{j I_0 \sin \theta \cdot e^{j\omega(t - \frac{r}{c})}}{2\lambda r} \int_{-L/2}^{+L/2} \cos \frac{2\pi}{\lambda} \cdot z \cdot e^{j \frac{\omega \cos \theta}{c} \cdot z} dz \quad (7)$$

Let  $\beta = \omega/c = 2\pi/\lambda$ ; **eq. 7** may be rewritten:

$$H_\phi = \frac{j \beta I_0 \sin \theta \cdot e^{j\omega(t - \frac{r}{c})}}{4\pi r} \int_{-L/2}^{+L/2} e^{j \beta z \cos \theta} \cos(\beta z) dz \quad (8)$$

Since  $\int e^{ax} \cdot \cos(bx) dx = \frac{e^{ax}[a \cos(bx) + b \sin(bx)]}{a^2 + b^2}$

and if  $a = j \beta \cos \theta$  and  $b = \beta$ , then **eq. 8** becomes:

$$H_\phi = \frac{j \beta I_0 \sin \theta \cdot e^{j\omega(t - \frac{r}{c})}}{4\pi r} \quad (9)$$

$$\left[ \frac{e^{j \cos \theta \cdot \beta z}}{\beta^2 (\sin^2 \theta)} (j \beta \cos \theta \cdot \cos \beta z + \beta \cdot \sin \beta z) \right]_{-L/2}^{+L/2}$$

Evaluating this expression at both limits and collecting terms:

$$H_\phi = \frac{j [I_0]}{2\pi r} \cdot F(\theta)$$

where  $[I_0] = I_0 e^{j\omega(t - \frac{r}{c})}$

and  $F(\theta) =$  **(10)**

$$\left\{ \frac{\cos(\frac{\beta L}{2} \cdot \cos \theta) \sin \frac{\beta L}{2} - \cos \theta \cdot \sin(\frac{\beta L}{2} \cdot \cos \theta) \cos \frac{\beta L}{2}}{\sin \theta} \right\}$$

$F(\theta)$  is often referred to as the field pattern factor. Thus the far fields of the truncated element can be written:

$$H_\phi = \frac{j [I_0]}{2\pi r} \cdot F(\theta) \quad (11)$$

and  $E_\theta = \frac{j 60 [I_0]}{r} \cdot F(\theta)$  **(12)**

Note that if there is no truncation ( $L = \frac{\lambda}{2}$ ) **eq. 10** reduces to the well-known expression for a  $\lambda/2$  dipole:

$$F(\theta) = \frac{\cos(\frac{\pi}{2} \cdot \cos \theta)}{\sin \theta} \quad (13)$$

Kraus has shown that the self-radiation resistance,  $R_{11}$ , of such a linear element can be computed by equating the integral of the Poynting vector over a large sphere (total power radiated) to the driving point (current maximum) total power supplied. The result is (see Kraus, <sup>1</sup> 5-90, page 143):

$$R_{11} = 60 \int_0^\pi F^2(\theta) \cdot \sin \theta d\theta \quad (14)$$

For the truncated element it is now a simple matter to insert the value of  $F(\theta)$  from **eq. 10** into **eq. 14** and integrate. The integration is quite easily done numerically with a simple computer program. The result of such an integration is shown in **table 2** where the radiation resistance of a truncated dipole element of length  $L$  (in terms of wavelength  $\lambda$ ) is shown.

The directivity or gain can also be easily computed. Once  $F(\theta)$  is given, the directivity is simply the ratio of the *maximum* value of  $F^2(\theta)$  to the *average* value of  $F^2(\theta)$  over the entire  $4\pi$  solid angle. That is, the directivity  $D$  is:

$$D = \frac{F^2(\theta = \frac{\pi}{2}) \cdot 4\pi}{2\pi \int_0^\pi F^2(\theta) \sin \theta d\theta} \quad (15)$$

or from **eq. 14**

$$D = \frac{120}{R_{11}} F^2\left(\theta = \frac{\pi}{2}\right) = \frac{120}{R_{11}} \cdot \sin^2\left(\frac{\beta L}{2}\right) \quad (16)$$

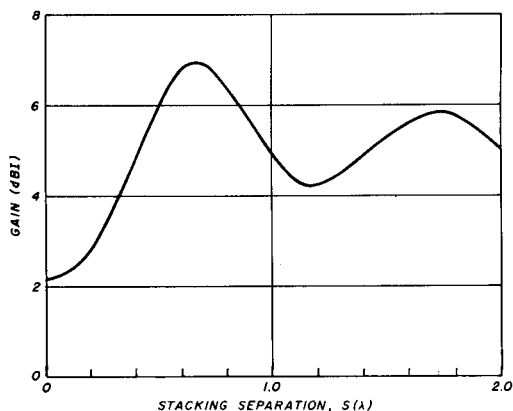

fig. 3. "Stacking" gain vs separation for two side-by-side dipoles.

The calculated directivity,  $D$ , and the related gain, expressed in dBi, are also listed in table 2.

Note that for small truncations where  $L$  is only slightly shorter than  $\lambda/2$  there is not much reduction in self-radiation resistance and not much reduction in directivity; this is to be expected because the small ends of the dipole which are truncated carry little current, so do not contribute greatly to element performance. For heavy truncation, however, both self-radiation resistance and directivity decrease significantly; the limiting case where the length goes to zero is the well-known infinitesimal dipole whose directivity is just 1.500 and gain is 1.761 dBi.

To compute the driving-point resistance of the full quad square loop it is necessary to know the mutual resistance between two (truncated) elements separated by  $\lambda/4$ . From quite fundamental considerations Hurwitz<sup>2</sup> has shown a mathematical expression for the real part of the complex mutual impedance between two elements,  $R_{21}$ :

$$R_{21} = 60 \int_0^\pi F^2(\theta) \cdot \sin \theta \cdot J_0(\beta S \cdot \sin \theta) d\theta \quad (17)$$

where  $F(\theta)$  is the pattern function and  $J_0$  is the Bessel function whose argument is the product of element separation  $S$  and  $\beta \cdot \sin \theta$ . If  $S$  is measured in units of  $\lambda$  the argument is simply  $(2\pi S \cdot \sin \theta)$ . Note that for very small separations  $J_0$  approaches unity; for very close separations  $R_{21} \cong R_{11}$ .

Shown in table 3 are values of mutual resistance vs separation ( $\lambda$ ) of truncated elements. Note that the mutual resistance behaves very similarly to the values for full half-wavelength dipoles<sup>3</sup> but the magnitudes are much smaller; a careful comparison shows that the reduction factor varies somewhat with separation.

The properties of the square quad loop can now be computed. Table 2 shows that the gain of a *single* (truncated)  $\lambda/4$  element is 1.922 dBi and that

$R_{11} = 38.547$  ohms. For the full quad loop of fig. 2 there are two "elements;" if they are both equally driven, they will produce the same far-field strength and power density as a single driven "element" carrying twice the current. However, the driving-point resistance of each one of the driven elements, when both elements are equally excited, is  $R_{11} + R_{12}$ . Therefore, total input power (both elements) is:

$$W_2 = 2 \cdot I^2 (R_{11} + R_{12}) \quad (18)$$

While for the single element alone (same far field) is:

$$W_1 = (2I)^2 \cdot R_{11} \quad (19)$$

If the directivity of a single element is designated as  $D_1$  and the directivity of the full quad loop as  $D_2$ , then

$$D_2 = D_1 \frac{W_1}{W_2} = 2D_1 / (1 + R_{12}/R_{11}) \quad (20)$$

From tables 2 and 3 values for the square quad loop are:  $R_1 = 38.547$  ohms;  $R_2 = 21.729$  ohms;  $D_2/D_1$  becomes 1.279 or 1.069 dB. Note that this *stacking* gain of the two truncated elements is nearly identical to the stacking gain of half-wavelength dipoles at a separation of  $\lambda/4$  (1.085 dB, see table 1); the difference is due only to the details of mutual resistance. The driving-point resistance,  $R$ , of the total loop, of course, is twice the value for a single element (when both are driven):

$$R = 2(R_{11} + R_{12}) = 120.6 \text{ ohms} \quad (21)$$

Since  $D_1$  (see table 2) is 1.557,

$$D_2 = 1.991 \text{ and} \quad (22)$$

$$\text{Gain} = 2.992 \text{ dBi} \quad (23)$$

These properties of the square quad loop have been obtained rather rigorously; the main assumption in the model is total neglect of far-field radiation from the vertical sections, which are assumed to act as capacitance sinks for the current at the ends of the horizontal radiating segments. Moreover, the assumption is made that the current distribution on

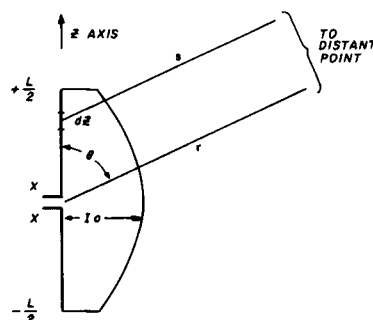

fig. 4. Current relationships for the symmetrical, thin center-fed truncated antenna of length  $L$ . This is the relationship necessary to determine driving-point impedance and H- and E-plane patterns of the square quad loop.

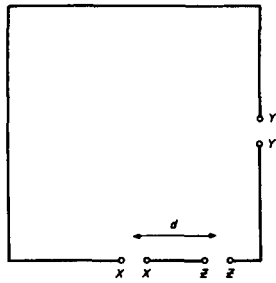

fig. 5. Example of a square loop with the excitation applied at one of three different places.

the horizontal segments is strictly sinusoidal; this is valid for very thin elements. Most quad loops are built with wire, which is thin compared to a wavelength, so one can be quite confident of the model.

It is now easy to understand qualitatively the radiation pattern of the loop. The  $H$ -plane profile does narrow, compared with a single linear element, because of the "illumination" of a wider vertical aperture; quantitatively, this profile narrowing is almost the same for truncated quad "elements" and the equivalently separated half-wavelength dipoles. The  $E$ -plane profile, however, is not as narrow for the truncated element as for a half-wavelength dipole; this factor accounts for the somewhat reduced directivity (see table 2). The loss in gain is about 0.23 dB for the  $\lambda/4$  truncated element.

### other driven loops

Before I consider a multiloop quad system I will briefly discuss other forms of driven loops. First, I will determine the performance of the square quad loop when it is driven or excited at a point other than the center of the bottom segment. Fig. 5 shows the square loop with three different feed points: the center of the bottom leg  $xx$ , the center of the right vertical leg  $yy$ , and at an arbitrary point,  $zz$ , placed at a counter-clockwise distance  $d$  (from  $xx$ ) around the loop. It has already been shown that if excitation is applied at  $xx$  (with  $yy$  and  $zz$  shorted), the loop will produce a totally horizontally polarized far field; its gain is 2.992 dBi. Similarly, if excitation is applied at  $yy$  (with  $xx$  and  $zz$  shorted), only vertically polarized far-field radiation will occur; gain is again just 2.992 dBi. Note that excitation at  $xx$  and  $yy$  are basically independent, i.e., unit current flow due to excitation at  $xx$  has a null current at  $yy$  and vice versa.

If we now excite the loop at  $zz$  with the same unit current,  $I_0 \cos \omega t$ , it is easy to see that current flow at  $xx$  is just  $I_0 \cos(\beta d) \cos \omega t$  and at  $yy$  is  $I_0 \sin(\beta d) \cos \omega t$ . These currents will produce orthogonal far fields which must be added vectorially to obtain the total far field; the total far field has exactly the same mag-

nitude as that which is produced by the same unit current at  $xx$  alone. In other words, the square loop gain and drive-point resistance are totally independent of the feed point; only the polarization changes (from totally horizontal if the feed is at  $xx$  to totally vertical if the feed is at  $yy$ ). This simple theorem can be easily proved by the same type of argument for any equilateral one-wavelength loop.

It is now interesting to consider moving the feed-point  $zz$  to the lower right-hand corner of the square loop. Since we are considering free space loop gain for which rotation is unimportant, it is clear that this configuration produces *exactly* the same result as the familiar square *diamond* loop fed at the bottom or top corner. Thus we now know that the quad square and the diamond square have *exactly* the same gain and *exactly* the same drive-point resistance. Similarly, the gain and drive-point resistance of *any* equilateral (one-wavelength) loop is *totally* independent of the position of the drive point on the loop.

I shall now return to the horizontally polarized square of fig. 2. We have shown that a square loop (relative to a half-wave dipole) has a somewhat enhanced gain (+0.84 dB), made up of an increase (+1.07 dB) due to the vertical separation of the radiating segments ( $H$ -plane narrowed somewhat) and a decrease (-0.23 dB) due to the shortened or truncated radiating segments ( $E$ -plane broadening). Let's now explore the performance of a *rectangular* one-wavelength loop; fig. 6 shows some examples.

Rectangle **A** is a wide but low loop which is recognized as a folded dipole loop; **B** is a narrower and higher loop than the square, and **C** is a high but very narrow loop. For all of these loops the sum of the width,  $W$ , and height,  $H$ , measured in wavelengths is constrained to be just 0.5. We are now in a position

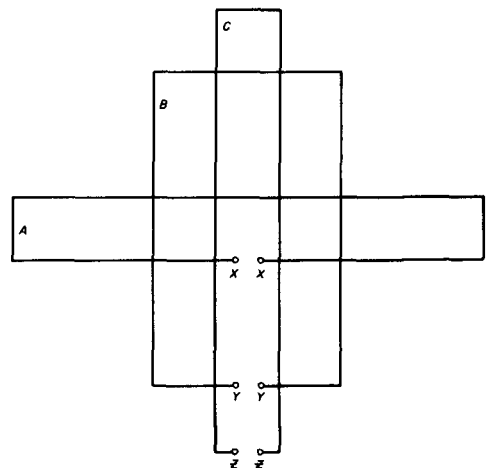

fig. 6. Diagram of three different rectangular configurations. In each case the feed point is located for horizontally polarized radiation.

**table 1. Stacked half-wavelength dipoles showing gain vs. dipole separation.**

separation S( $\lambda$ )	gain (dBi)	stacking gain (dB)
0.000	2.151	0.000
0.125	2.425	0.274
0.250	3.236	1.085
0.375	4.514	2.363
0.500	5.978	3.827
0.625	6.938	4.787
0.750	6.758	4.607
0.875	5.831	3.680
1.000	4.929	2.778
1.250	4.373	2.222
1.500	5.275	3.124
1.750	5.844	3.693
2.000	5.097	2.946

to compute loop performance. **Table 4** shows the results of calculations for rectangular loops by the same methods as used for the square.  $D_2/D_1$  is the  $H$ -plane directivity increase due to the vertical separation of radiating segments (see **eq. 20**), while  $D_1$  is the directivity of a single horizontal radiating segment (see **table 1**).  $R$  is the loop driving point resistance (see **eq. 22**). Note that the limiting case of the folded dipole ( $W = 0.5, H = 0$ ) shows a gain of 2.151 dBi (identical to a single half-wave dipole) and a driving-point resistance of 292.5 ohms (just four times that of a single half-wave dipole). Since reactance effects of the full loop are double that of a single "element," the  $Q$  of the folded dipole will be just one-half the  $Q$  of a single half-wave dipole, leading automatically to a bandwidth twice as large. As one reduces the loop width from this limiting case the gain increases monotonically. However, this favorable increase in gain is automatically accompanied by a significant reduction in driving point resistance; since reactance effects are essentially identical for all loops, the circuit  $Q$  increases commensurately. Thus the potential gain obtainable from high narrow loops is always offset by unfavorably high values of  $Q$  and corresponding narrow bandwidths!

**table 2. Self-resistance and gain for one truncated element.**

element length ( $\lambda$ )	$R_{11}$ (ohms)	directivity	gain dBi
0.05	1.955	1.502	1.768
0.10	7.590	1.510	1.789
0.15	16.255	1.522	1.823
0.20	26.966	1.537	1.868
0.25	38.547	1.557	1.922
0.30	49.780	1.578	1.980
0.35	59.562	1.599	2.040
0.40	67.023	1.619	2.094
0.45	71.612	1.635	2.134
0.50	73.130	1.641	2.151

Let us now consider other loop shapes. For equilateral shapes, we have already seen that gain and driving-point resistance are independent of feed-point resistance on the loop. Moreover, a reasonably rigorous solution has been obtained for a square loop. Because of the independence of properties on feed-point position, which is equivalent to independence on loop rotation with feed point fixed at the bottom, it seems reasonable to assume that gain from all equilateral loops is approximately equal to that of a circular loop having the same enclosed area. This in turn can be equated to an equivalent square of the same area. Such an intuitive model, together with a model of how  $E$ -plane directivity varies with element length (see **table 2**) and how  $H$ -plane directivity varies with element separation (see **table 1**), allows a reasonable estimate of equilateral loop gain. **Table 5** lists these values for several equilateral loops. The values for the square are the ones already computed (see **table 4**); all others are estimated by

**table 3. Mutual resistance,  $R_{12}$ , for  $\lambda/4$  truncated elements vs. separation in  $\lambda$ .**

separation ( $\lambda$ )	mutual resistance (ohms)	separation ( $\lambda$ )	mutual resistance (ohms)
0.00	38.547	0.80	-9.783
0.05	37.782	0.85	-7.165
0.10	35.536	0.90	-4.194
0.15	31.951	0.95	-1.142
0.20	27.251	1.00	1.730
0.25	21.729	1.10	6.083
0.30	15.721	1.20	7.713
0.35	9.589	1.30	6.481
0.40	3.686	1.40	3.190
0.45	-1.659	1.50	-0.787
0.50	-6.170	1.60	-4.008
0.55	-9.636	1.70	-5.450
0.60	-11.930	1.80	-4.806
0.65	-13.010	1.90	-2.518
0.70	-12.919	2.00	0.446
0.75	-11.780		

this simple model. It is quite easy to see that the popular triangle or delta loop is slightly lower in gain (by 0.3 dB) than the square (quad or diamond) and that the loop with the highest gain is a circle. However, note that the gain of the circular loop is estimated as 3.28 dBi which is 1.13 dB larger than that of a half-wave dipole. This is not quite as large an increase as the approximately 2 dB which was quoted by Lindsay,<sup>4</sup> but I believe this discrepancy is probably not outside of the experimental accuracy range of Lindsay's measurements combined with the estimation accuracy range of the simple model I have used.

I shall now consider a multiloop square quad array where not only driven elements but parasitic loops as well are used. From what we have just seen, the

table 4. Properties of the rectangular loop.

width w(λ)	height H(λ)	D <sub>1</sub>	D <sub>2</sub> /D <sub>1</sub>	D <sub>2</sub>	gain dBi	R ohms
0.05	0.45	1.502	2.073	3.114	4.933	3.77
0.1	0.4	1.510	1.815	2.741	4.379	16.7
0.15	0.35	1.522	1.596	2.430	3.856	40.8
0.2	0.3	1.537	1.419	2.181	3.386	76.0
0.25	0.25	1.557	1.279	1.991	2.990	120.5
0.3	0.2	1.578	1.172	1.850	2.672	169.8
0.35	0.15	1.599	1.094	1.750	2.430	217.7
0.4	0.1	1.619	1.041	1.686	2.267	257.5
0.45	0.05	1.635	1.010	1.652	2.179	283.6
0.5	0.0	1.641	1.000	1.641	2.151	292.5

quad array should behave just about like an equivalent stacked Yagi array separated (vertically) by  $0.25\lambda$  and having elements bent together to form the individual square quad loops. However, to proceed with a computation of the properties of the parasitic quad array, we must know all complex self and mutual impedances of the truncated elements. Up to this point it has been possible to rather rigorously describe the properties of a driven loop because only the real part of self and mutual impedances were required to obtain gain, driving-point resistance, and pattern information (both in the *E*- and *H*-planes).

When parasitic elements are involved, the imaginary impedance terms are required. Computation of the imaginary impedances is a non-trivial exercise, and I am unaware of any rigorous procedure for carrying out such a calculation for truncated elements. As far as self-impedance is concerned, the reactive or imaginary value is controlled entirely by the "tuning" of the loop; that is, the relationship of wavelength to loop circumference and the effective loop *Q*. The complex impedance has been calculated for a linear nearly half-wave thin cylindrical element.<sup>5</sup> The method involves treating the metallic cylinder as a boundary-value problem (tangential components of electric field are made to vanish at every point on the conductor surface), from which an integral equation is derived. Approximate solutions of this integral equation yield the current distribution on the cylindrical element from which the input impedance, including the imaginary component, was derived.

I have been unable to find an equivalent rigorous boundary-value calculation for the square quad loop; thus we do not yet have the basis for calculating the precise reactance for a nearly one-wavelength square loop. However, it is possible to at least estimate the loop *Q* (but not its precise resonant frequency) by remembering that reactance changes with frequency are due to the effective inductance and capacitance of the antenna; that is, near-field stored energies, whereas the resistance (radiation) has to do with far

field. Truncating the half-wave dipole changes the geometry of the element but hardly affects its (central) inductance or (end) capacitance. It would be reasonable, therefore, to assume the quad loop contains essentially the same total reactive impedance changes as two half-wave dipoles. Thus, following the argument made in a previous article,<sup>3</sup> we may write for the loop self-impedance:

$$Z_{11} = R_{11} + jX_{11} = R_{11} [1 + j \cdot 2Q(F/FR - 1)] \quad (24)$$

but (empirically)

$$R_{11}Q = (430.3 \log_{10}K - 320) \quad (25)$$

so that

$$Z_{11} = 120.5 + j(860.6 \log_{10}K - 640)(F/FR - 1) \text{ ohms} \quad (26)$$

As in the previous article, *F* is the normalized frequency and *FR* the normalized resonant frequency of the loop. Loop *Q* is readily estimated from eqs. 25 and 21. The only remaining problem is a determination of *FR*. Although there is no rigorous way of calculating *FR* from basic principles, it is significant to note that the region where the ends of the two dipoles are joined must have electric (capacitive) fields at right angles to the conducting cylindrical element, exactly like those of an infinitely long straight cylinder near a voltage loop. This observation implies that there should be a negligible "end effect" at the capacitive voltage loop, and, therefore, *FR* should be very close to the frequency at which the total loop circumference is just one wavelength.

When we consider the imaginary part of the mutual impedance between loop halves or "elements," another computational complication arises. At long distances or separations, the imaginary mutual reactance, *X*<sub>21</sub>, must be (except for a phase shift) simply related to the real part, *R*<sub>21</sub>, and this relationship should be unaffected by the precise "tuning" of the "elements." However, at very small separations *X*<sub>21</sub> must approximate the value of *X*<sub>11</sub>, which is fundamentally fixed by circuit *Q* and resonant frequency and not at all by *R*<sub>11</sub>. How to correctly represent *X*<sub>21</sub> at all intermediate spacings has not, to my knowledge, been solved quantitatively. For this reason I will model the quad array first as the equivalent Yagi array stacked at a spacing of  $\lambda/4$  then, second, apply necessary corrections to direc-

table 5. Estimated equilateral loop properties.

equilateral loop type	sides	equivalent square side (λ)				gain dBi	R ohms
			D <sub>1</sub>	D <sub>2</sub> /D <sub>1</sub>	D <sub>2</sub>		
triangle	3	0.219	1.545	1.205	1.862	2.70	104.7
square	4	0.250	1.557	1.279	1.991	2.99	120.5
pentagon	5	0.262	1.562	1.309	2.044	3.10	126.4
hexagon	6	0.269	1.565	1.324	2.071	3.16	129.3
octagon	8	0.275	1.567	1.338	2.097	3.22	132.0
circle	∞	0.282	1.570	1.356	2.129	3.28	135.3

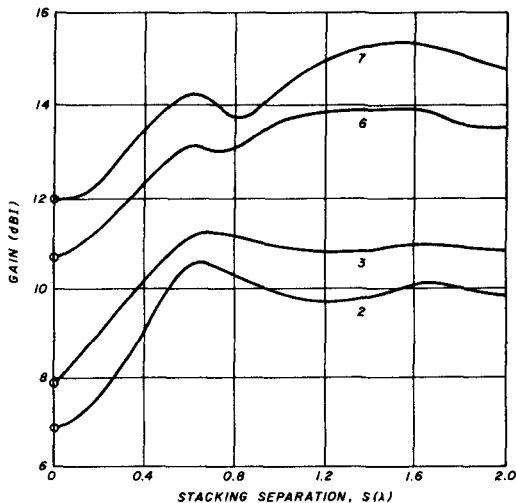

fig. 7. Representative examples of stacking gain for 2, 3, 6, and 7-element Yagis vs the stacking separation.

tivity and gain. Compared with stacked ( $\lambda/2$  element) Yagis, the square quad will have 0.23 dB less directivity and gain (all due to  $E$ -plane pattern broadening).

It is interesting to calculate the free-space "stacking gain" of Yagis as a function of vertical separation. I chose as representative boom lengths and number of elements the following simplistic Yagis, which were found to have excellent free-space properties:<sup>6</sup> a two-element beam on a  $0.15\lambda$  boom, a three-element beam on a  $0.25\lambda$  boom, a six-element beam on a  $0.75\lambda$  boom, and a seven-element beam on a  $1.25\lambda$  boom. Table 6 lists characteristics of these beams.

Fig. 7 shows the computed gains of these stacked configurations as a function of the stacking separation,  $S$ , in units of  $\lambda$ . Note that the rise in gain due to  $S$  is somewhat different for each case and also somewhat different than the case for dipoles shown in fig. 3. Two things seem to be occurring as  $S$  is increased. For small separations, the capture area of one Yagi essentially overlaps that of the other Yagi; therefore, the total capture area for both is essentially the same as for one alone. As  $S$  increases, the total capture area increases and ultimately doubles if  $S$  is large enough. For the larger Yagis (where the original cap-

table 6. Characteristics of representative beams. Radius of all elements =  $0.0005260\lambda$ .

number elements	length ( $\lambda$ )		dir.	boom element length spacing		fig. 7 curve
	reel	driven		( $\lambda$ )	( $\lambda$ )	
2	.4937	.4705	—	0.15	0.150	2
3	.4980	.4896	.4690	0.25	0.125	3
6	.4953	.4803	.4481	0.75	0.150	6
7	.4936	.4762	.4466	1.25	0.208	7

ture area for one Yagi is large), it is easy to see that to realize a given separation, gain  $S$  must be relatively larger than for a small Yagi or especially a dipole. In other words, the transition from the gain of one large Yagi to the doubling of gain (3-dB increase) for two large Yagis requires a larger separation than is required for smaller Yagis. In addition to this rather gradual gain increase due to separation of capture areas, fig. 7 suggests that the constructive interference due to mutual impedances noticed for the dipoles in fig. 3 also persists in stacked Yagis. An increase in gain is noticeable at  $S = 0.6$  and also at 1.6. Qualitatively, fig. 7 shows a combination of these two effects; first, the constructive impedance gain increases at particular separations and second, the capture area separation gain increase which takes place more slowly with large Yagis.

It is interesting to compare the computed gain increase of the seven-element beam with the experimental values reported by Viezbicke<sup>7</sup> in his fig. 11A. Table 7 shows a comparison of my computed results with Viezbicke's published experimental values. The comparison is not totally valid because Viezbicke's seven-element beam is not the same beam I have

table 7. Stacking gain (dB) of seven-element beams.

spacing $S$ ( $\lambda$ )	(Viezbicke) 7 element	computed 7 element
0.38	0.80	1.3
0.57	1.58	2.15
0.78	1.36	1.8
0.99	1.90	2.35
1.20	2.34	3.0
1.40	2.53	3.25
1.61	1.93	3.3

used in fig. 7. The differences cannot be quantified, since Viezbicke failed to include specifications for his seven-element beam. Nevertheless, table 7 shows good qualitative agreement and even fair quantitative agreement (close to Viezbicke's stated experimental accuracy of 0.5 dB).

Computations represented by the data shown in fig. 7 cannot really be carried down to very small separations with any confidence because the mathematical model uses mutual impedances of full  $\lambda/2$  elements. When reactive parasites get very close together their mutual impedance has an imaginary value quite different from that of  $\lambda/2$  dipoles.

I shall now examine the stacking gain increases for a separation of  $\lambda/4$ . Table 8 shows these increases for the four computed cases (dipole data from fig. 3). Note that the  $\lambda/4$  stacking gain for very large Yagis is not as large as that for dipoles;

this can easily be understood because of the (relatively) smaller increase in capture area. One might expect this gain increase to fall monotonically from the value of 1.09 dB (for dipoles) as the array length is increased, however, **table 8** shows the actual increase to vary somewhat due to the detailed way in which impedances vary.

We are now in a position to estimate the performance of a quad array. If instead of the dipole elements of the stacked ( $\lambda/4$ ) Yagi arrays I use (bent) elements connected in square loops, I will make a quad array in which all conditions remain about the same *except* that the *E*-plane pattern is broadened and the gain is correspondingly reduced due to the truncated "elements." The gain performance of the quad array is therefore about 0.23 dB lower than the stacked  $\lambda/4$  Yagis. These estimations are also shown in **table 8**.

**table 8.** Quarter wavelength stacking gain for Yagis and estimated quad/single Yagi gain.

number elements	boom length ( $\lambda$ )	Yagi $S = \lambda/4$ stacking gain (dB)	quad/single Yagi gain difference (dB)
1	0.0	1.09	0.86
2	0.15	1.03	0.80
3	0.25	1.38	1.15
6	0.75	0.84	0.61
7	1.25	0.65	0.42

It must be evident by now that a square quad array is very much like an equivalent Yagi. Its overall gain is expected to be somewhat higher than the Yagi because of individual loop gain, but not by very much. *E*-plane pattern is slightly broader due to the current distribution on the truncated "elements," whereas *H*-plane pattern is slightly narrower due to the "stacking gain" of the loops. Because of this similarity of Yagi and quad arrays, it is plausible that one can intermix quad loops and Yagi elements to provide a hybrid structure of roughly equal performance. Such a hybrid is known as a "quagi;" if properly constructed, it should provide a pattern and gain intermediate between a similar quad and a similar Yagi. There are obviously an enormous variety of possible quagi configurations; there will remain for some time a challenge to the quagi designer to determine preferred configurations and best dimensions for all radiating elements.

### summary

A number of interesting conclusions have been reached regarding antenna arrays constructed with conducting loops roughly one wavelength in circumference.

1. A single (driven) loop will provide a free-space gain somewhat larger than that of a half-wave dipole. The gain increase comes about through a narrower *H*-plane pattern and a slightly broader *E*-plane pattern.

2. Loop gain varies significantly with shape. For rectangular loops fed in the center of the lower horizontal segment, gain depends on the ratio of height, *H* to width, *W*, varying from 2.15 dBi (equal to a half-wave dipole) if  $H/W = 0$  to about 5 dBi (3.8 dB above a half-wave dipole) as  $H/W$  approaches zero.

3. For equilateral loops, gain depends only on the number of sides (see **table 5**). For the square loop, the free-space gain calculated rather rigorously is 2.99 dBi and driving-point resistance is 120 ohms. It is significant that these properties of the square loop are totally independent of the feed point on the square. As an example, the gain and drive-point resistance for a quad square is *exactly* the same as that of the diamond square.

4. The free-space gain of a quad array is estimated to be somewhat higher than that of an equivalent (single) Yagi. Calculations show this difference depends somewhat on the particular array (see **table 8**), but ranges from about 1 dB for short arrays to less than 0.5 dB for long arrays.

5. Quagi configurations are expected to show performance figures between those of an equivalent Yagi and equivalent quad.

6. A rigorous theory does not yet exist for self and mutual quad loop reactances. Consequently, quad (and quagi) parasitic loops must be experimentally adjusted for correct resonant frequency. It is unlikely that such experimental adjustments can be made with the same precision and confidence that Yagi element lengths can now be specified by present theory. Therefore, the slight gain advantage of the quad over the Yagi shown in **table 8** may well disappear in practice.

### references

1. J. D. Kraus, "Antennas," McGraw-Hill Book Co., Inc., New York, NY.
2. H. Hurwitz, W2HH, Private communication.
3. J. L. Lawson, W2PV, "Yagi Antenna Design," *ham radio*, January, 1980, page 22.
4. J. Lindsay, "Quads and Yagis," *QST*, May, 1968.
5. E. Hallen, "Theoretical Investigations into the Transmitting and Receiving Qualities of Antennae," *Nova Acta Uppsala*, Ser. IV, Vol. 11, No. 4, pages 3-44, 1938.
6. J. L. Lawson, W2PV, "Yagi Antenna Design," *ham radio*, May, 1980, page 18; June, 1980, page 33.
7. P. Viezbicke, "Yagi Antenna Design," *NBS Technical Note 688*, U.S. Department of Commerce, Washington, D.C., December, 1976.

ham radio

# navigation aid

## for small-boat operators

An idea  
for approaching  
harbor entrances  
using two simple  
beacon transmitters  
and a harmonic  
phase detector

Many small-boat operators have probably wished for a simple navigational aid during fog, darkness, or other hazards. The system suggested here provides guidance between two simple low-powered transmitters, which may be located on opposite sides of a channel, breakwater entrance, or even on a wharf that may be the goal of the boat. It's a sort of SHORAN system, with simplifications, which should put it well within the technical ability, as well as the pocketbook, of the average Amateur.

### theory

Consider fig. 1, which shows points **A** and **B**, representing the location of two transmitters, which may be battery powered and in the milliwatt range. Our boat is located at point **C**, and our aim is to guide the boat between points **A** and **B** using signals transmitted from these two points. Transmitters at **A** and

**B** operate on closely chosen radio frequencies, which differ by some arbitrary audio frequency, perhaps several hundred to one thousand Hz. The frequency separation is well within the passband of a receiver located on the boat at point **C**. Receiver output, therefore, is the beat frequency caused by this difference in the transmitted frequencies.

If now, the boat maneuvers so that the path length between it and the higher-frequency transmitter becomes relatively shorter than the path to the lower-frequency transmitter, the phase of the received beat frequency signal will advance. This effect may be generalized by stating that the received beat frequency is phase-variant with the position of point **C**, the point of reception.

### analysis

A number of paths exist along which the receiving point, **C**, can move without changing the phase of the beat note. These paths are a family of hyperbolas, all of which pass between **A** and **B**. On the line **AB**, they will be a half-wavelength apart, but as they appear further from line **AB**, they separate. This, in effect will "funnel" the boat between the two target points. The number of these paths will be a function of the separation between **A** and **B** in wavelengths (fig. 2).

To use this phase-variant characteristic of the beat frequency, a reference signal is needed with which the beat frequency can be compared. The generation and transmission of this signal is a relatively simple process, for which two alternatives exist.

### reference signal

In the antenna feedline of either transmitter, we can insert a directional coupler. While signals from the local transmitter are being radiated from this antenna, signals from the other transmitter will be

By Henry S. Keen, W5TRS, Fox, Arkansas 72501



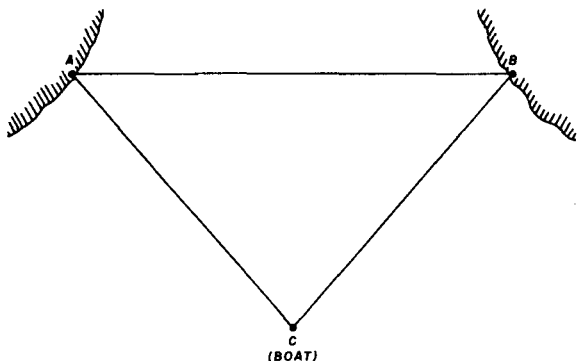

fig. 1. Example of a typical navigational problem. Beacon transmitters are at points A and B at a harbor entrance. Guidance may be provided to a small boat entering the channel using the idea in the text.

picked up. The directivity of this coupler is used to reduce the local signal, while accepting as much as possible of the received signal from the other transmitter.

When detected, a beat note is produced, which is the same frequency as that received at point C, but which is completely independent of the position of point C. In other words, here is our reference signal.

It could be transmitted to point C by using it to modulate a transmitter operating on a third frequency, but this would require a considerable amount of additional equipment both on shore as well as on the boat. Instead, we can double the beat frequency thus produced and use it to amplitude-modulate that transmitter, to a modest percentage, probably below 50 per cent, to avoid distortion. Appropriate filtering built into the modulator system will remove the fundamental.

The second alternative would be to divide the beat frequency by two, and with appropriate filtering, as before, use it to modulate that transmitter. Frequency division by digital methods should produce a symmetrical square wave, which would contain, theoret-

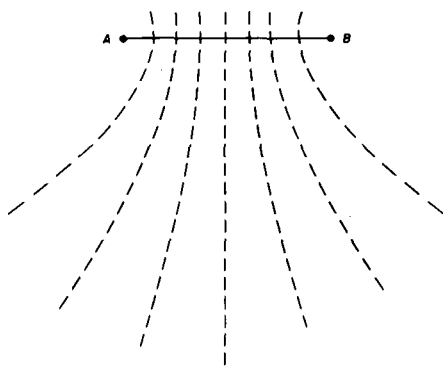

fig. 2. Geometry of equi-phase paths between points A and B of fig. 1. In this example  $AB = 4$  wavelengths. Paths above AB line are the mirror image of those below.

cally, no trace of its second harmonic, which of course is the beat-note fundamental.

This square wave would have to be reduced to a sine wave by some means, such as a low-pass filter to remove harmonics. A square wave contains only odd harmonics, so this doesn't appear too difficult for several stages of RC feedback filtering with a multiple op-amp.

### phase detector

Now let us move to the boat, at point C. Its receiver will be producing two audio frequencies, having a 2:1 frequency relationship, one of which is phase-variant with the boat's position. This audio-frequency signal is now fed into a harmonic phase detector, fig. 3, which responds to two such harmonically related signals, giving 1) a balanced zero voltage when both signals cross the zero axis simultaneously, and 2) a positive or negative voltage, according to which signal crosses the zero axis before the other (reference 1).

The differential voltage produced by the phase

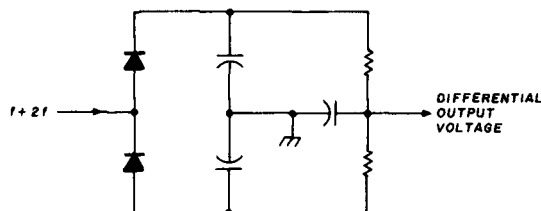

fig. 3. Harmonic phase detector produces a differential voltage that can be used to drive a zero-center meter that will deviate from center in accordance with the boat's deviation from one of the equi-phase paths in fig. 2.

detector is easily amplified to drive a zero-center meter, which will deviate from center in accordance with the boat's deviation from one of the equi-phase paths.

### some final thoughts

I suspect that such a system might operate, for example, in one of the 20-kHz slots that appear in the CB spectrum. This would reduce the acquisition of new equipment by the average boat enthusiast to a bare minimum. If he stayed too late at the fishing grounds, he could call the operator of the marina where he keeps his craft and ask him to set the beacons out by the entrance through the breakwater. The marina operator should enhance his popularity by doing so, not only with his own customers, but with the boating fraternity in general.

### reference

1. Henry S. Keen, W5TRS, "Harmonic Phase Detector," *ham radio*, August, 1974, page 40.

ham radio

# Easy selection.



## 15 memories/offset recall, scan, priority, DTMF

Touch-Tone®

### TR-7800

Kenwood's remarkable TR-7800 2-meter FM mobile transceiver provides all the features you could desire for maximum operating enjoyment. Frequency selection is easier than ever, and the rig incorporates new memory developments for repeater shift, priority, and scan, and includes a built-in autopatch DTMF encoder.

#### TR-7800 FEATURES:

- **Extended frequency coverage**  
143 900-148 995 MHz, in switchable 5-kHz or 10-kHz steps.
- **Built-in autopatch DTMF (Touch-Tone®) encoder**
- **Front-panel keyboard**  
For frequency selection, transmit offset selection, memory programming, scan control, and selection of autopatch encoder tones.
- **Autoscan**  
Entire band (5-kHz or 10-kHz steps) and memories. Automatically locks on busy channel; scan resumes automatically after several seconds, unless CLEAR or mic PTT button is pressed to cancel scan.
- **Up/down manual scan**  
Entire band (5-kHz or 10-kHz steps) and memories, with UP/DOWN microphone (standard).
- **Repeater reverse switch**  
Handy for checking signals on the input of a repeater or for determining if a repeater is "upside down".
- **Separate digital readouts**  
To display frequency (both receive and transmit) and memory channel.
- **Selectable power output**  
25 watts (HI)/5 watts (LOW).
- **LED bar meter**  
For monitoring received signal level and RF output.
- **LED indicators**  
To show +600 kHz simplex, or -600 kHz transmitter offset; BUSY channel; ON AIR.
- **15 multifunction memory channels, easily selectable with a rotary control**  
M1-M13 ... memorize frequency and offset ( $\pm 600$  kHz or simplex)  
M14 ... memorize transmit and receive frequencies independently for nonstandard offset  
M0 ... priority channel, with simplex,  $\pm 600$  kHz, or nonstandard offset operation
- **Internal battery backup for all memories**  
All memory channels (including transmit offset) are retained when four AA NiCd batteries (not Kenwood-supplied) are installed in battery holder inside TR-7800. Batteries are automatically charged while transceiver is connected to 12-VDC source.
- **Priority alert**  
M0 memory is priority channel. "Beep" alerts operator when signal appears on priority channel. Operation can be switched immediately to priority channel with the push of a switch.

- **TONE switch**  
To actuate subaudible tone module (not Kenwood-supplied).
- **Compact size**  
Depth is reduced substantially.
- **Mobile mounting bracket**  
With quick-release levers.

See your Authorized Kenwood Dealer now for details on the TR-7800 ... the remarkable 2-meter FM mobile transceiver!

**NOTE:** Price, specifications subject to change without notice and obligation

#### MATCHING ACCESSORY:

- KPS-7 fixed-station power supply



# Small wonder.



## Processor, N/W switch, IF shift, DFC option

### TS-130S/V

An incredibly compact, full-featured, all solid-state HF SSB/CW transceiver for both mobile and fixed operation. It covers 3.5 to 29.7 MHz (including the three new Amateur bands!) and is loaded with optimum operating features such as digital display, IF shift, speech processor, narrow/wide filter selection (on both SSB and CW), and optional DFC-230 digital frequency controller. The TS-130S runs high power and the TS-130V is a low-power version for QRP applications.

#### TS-130 SERIES FEATURES:

- **80-10 meters, including three new bands**  
Covers all Amateur bands from 3.5 to 29.7 MHz, including the new 10, 18, and 24-MHz bands. Receives WWV on 10 MHz. VFO covers more than 50 kHz above and below each 500-kHz band.
- **Two power versions . . . easy operation**  
TS-130S runs 200 W PEP/160 W DC input on 80-15 meters and 160 W PEP/140 W DC on 12 and 10 meters. TS-130V runs 25 W PEP/20 W DC input on all bands. Solid-state, wideband final amplifier eliminates transmitter tuning, and receiver wideband RF amplifiers eliminate preselector peaking.
- **Built-in speech processor**  
Increases audio punch and average SSB output power, while suppressing sideband splatter.

#### • CW narrow/wide selection

"N-W" switch allows selection of wide and narrow bandwidths. Wide CW and SSB bandwidths are the same. Optional YK-88C (500 Hz) or YK-88CN (270 Hz) filter may be installed for narrow CW.

#### • SSB narrow selection

"N-W" switch allows selection of narrow SSB bandwidth to eliminate QRM, when optional YK-88SN (1.8 kHz) filter is installed. (CW filter may still be selected in CW mode.)

#### • Sideband mode selected automatically

LSB is selected on 40 meters and below, and USB on 30 meters and above. SSB REVERSE position is provided on the MODE switch.

#### • Built-in digital display

Six-digit green fluorescent tube display indicates actual operating frequency to 100 Hz. Also indicates external VFO or fixed-channel frequency, RIT shift, and CW transmit/receive shifts. Also analog subdial for backup frequency indication.

#### • IF shift

Allows IF passband to be moved away from interfering signals and sideband splatter.

#### • Single-conversion PLL system

Improves stability as well as transmit and receive spurious characteristics.

#### • Built-in RF attenuator

For optimum rejection of intermodulation distortion.

#### • Built-in VOX

For convenient SSB operation, as well as semibreak-in CW with sidetone.

#### • Effective noise blanker

Eliminates pulse-type interference such as ignition noise.

#### • Built-in 25-kHz marker

Accurate frequency reference for calibration.

#### • Compact and lightweight

Measures only 3-3/4 inches high, 9-1/2 inches wide, and 11-9/16 inches deep, and weighs only 12.3 pounds. It is styled to enhance the appearance of any fixed or mobile station.



#### Optional DFC-230 Digital Frequency Controller

Allows frequency control in 20-Hz steps with UP/DOWN microphone (supplied with DFC-230). Includes four memories (handy for split-frequency operation) and digital display. Covers 100 kHz above and below each 500-kHz band. Very compact.

Ask your Authorized Kenwood Dealer about the compact, full-featured, all solid-state TS-130 Series.

**NOTE:** Price, specifications subject to change without notice and obligation.

#### MATCHING ACCESSORIES FOR FIXED-STATION OPERATION:

- PS-30 base-station power supply (remotely switchable on and off with TS-130S power switch).
- YK-88C (500 Hz) and YK-88CN (270 Hz) CW filters
- YK-88SN (1.8 kHz) narrow SSB filter
- AT-130 compact antenna tuner (80-10 m, including 3 new bands)
- MB-100 mobile mounting bracket
- SP-120 external speaker
- VFO-120 remote VFO
- MC-50 50kΩ/500Ω desk microphone
- Other accessories not shown:
  - MC-30S and MC-35S noise cancelling hand microphones
  - PC-1 phone patch
  - TL-922A linear amplifier
  - HS-5 and HS-4 headphones
  - HC-10 world digital clock
  - PS-20 base-station power supply for TS-130V



• SP-40 compact mobile speaker

• VFO-230 digital VFO with five memories

# optimum pi-network design

Methods for optimizing bandwidth without using the  $Q$  factor — design parameters and examples are given for this useful circuit

The familiar pi network shown in fig. 1 is both a lowpass filter and a simple impedance-matching network. Stray reactances at source or load may be compensated for by capacitor adjustment. Traditional design methods have used a  $Q$  factor to choose correct component values. This article presents design methods for optimizing bandwidth without using the  $Q$  factor.

The main function of the pi network is to provide a resistive match of source resistance,  $R1$ , with a load resistance,  $R2$ . An infinite number of component possibilities are available; two examples are shown in fig. 2.

This article was rewritten by Leonard H. Anderson, who is a member of the technical staff of Rocketdyne division of Rockwell International, Inc., and is well known for his contributions to *ham radio* in the *Digital Techniques* series. The *ham radio* staff expresses its thanks to Mr. Anderson for his help in interpreting this difficult subject.

## impedance transformation diagrams

Fig. 2 is useful for any simple network. Each resistance circle represents the series-form impedance of the parallel combination of end resistance with shunt reactance. This chart is used in the following manner:

1. Calculate series form  $R + jX$  of one end, including the shunt reactance.
2. Find the intersection on the resistance circle for both  $R$  and  $X$ .
3. Move vertically from this intersection to intercept the other resistance circle.

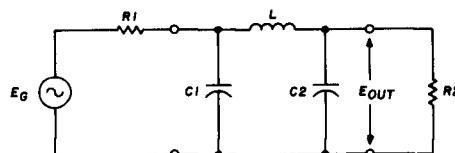

fig. 1. Classic pi network. Circuit is both a lowpass filter and impedance-matching device. Its main function is to provide a resistive match of source resistance,  $R1$ , with a load resistance,  $R2$ .

4. Measure the length of the vertical movement; this total reactance is the series-arm value.
5. Determine the reactance at the second intersection as measured from the zero reactance point ( $R$  axis passing through reactance axis).
6. Take the *opposite* reactance sign and calculate the new combination of parallel resistance and reactance.

The pi network first intersections are shown for the series impedance of  $R1$  and  $C1$ . Total vertical movement is the reactance of series inductor  $L$ . The

By Ulrich Fleischmann, DL9LX, Mollstrasse 6, D-68, Mannheim 1, West Germany

second intersections on the  $R_2$  circle represent the impedance presented to the inductor and  $R_1, C_1$ . To obtain a resistive match, the second intersections must be changed from a positive reactance to negative; this *conjugate* operation moves the  $Z_2$  intersection to the  $R$  axis.

As long as each set of intersections falls on each resistance circle, any component combination will yield a perfect impedance match. One particular combination will give the widest bandwidth, and some network synthesis techniques can be used to find that combination.

### image impedances

The image impedance of a network is the square root of the product of one input impedance with the other end open and the same input impedance with

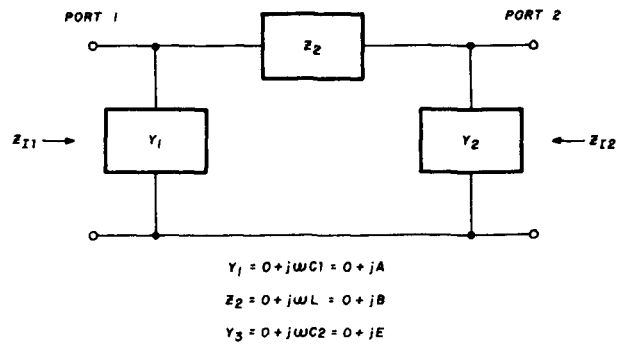

fig. 3. Pi-equivalent circuit composed of pure reactance and susceptances. These parameters at any frequency are derived in the text.

Using these matrix values, image impedance  $Z_{I1}$  becomes:

$$Z_{I1}^2 = Z_{o1}Z_{s1} = \frac{A_{11}A_{12}}{A_{21}A_{22}} = \frac{B(BE-1)}{(AB-1)(A+E-ABE)} \quad (1)$$

Letters  $A, B,$  and  $E$  are the susceptances and reactances at any frequency as given with fig. 3.  $Z_{o1}$  is the impedance into port 1 with port 2 open;  $Z_{s1}$  is the port-1 impedance with port 2 shorted. The image impedance at port 2 is:

$$Z_{I2}^2 = Z_{o2}Z_{s2} = \frac{A_{12}A_{22}}{A_{11}A_{21}} = \frac{B(AB-1)}{(BE-1)(A+E-ABE)} \quad (2)$$

$Z_{o2}$  and  $Z_{s2}$  are the port-2 impedances with port 1 open and shorted respectively. Both right-hand expressions are complex numbers with a zero-value imaginary component.

A broad spectrum plot of both image impedances is shown in fig. 4 for a typical network. It is common to denote frequency in such plots as  $\omega$ , the product of  $2\pi \times \text{frequency}$ . The dash lines indicate a negative-real-part image impedance.

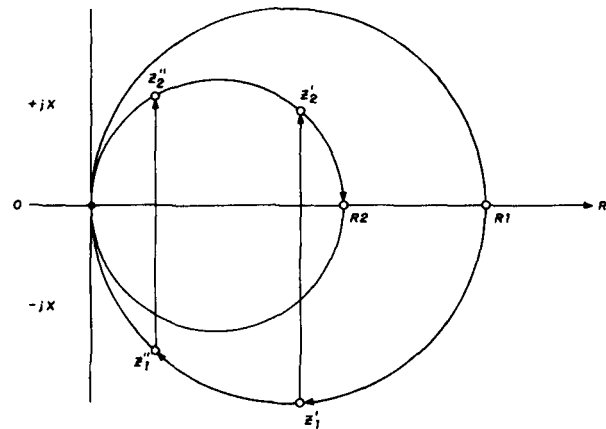

fig. 2. Impedance-transformation diagram. Each resistance circle represents the series-form impedance of the parallel combination of end resistance with shunt reactance.

the other end shorted. An image impedance is not the parameter for direct design but a mathematical tool for achieving the final solution.

The open/shorted opposite-end technique is used in microwave measurements where it's difficult to obtain a pure resistance.<sup>1</sup> At one particular frequency the image impedance will represent the actual input impedance when the opposite end is loaded with a resistance. An example is an infinite length of transmission line: at any frequency the image impedance is equal to the *characteristic impedance* of the line.

Fig. 3 shows the pi-equivalent circuit composed of pure reactance and susceptances. Using a matrix representation of the network, the following is true:

$$\begin{aligned}
 A_{11} &= 1 + Z_2 Y_3 & A_{12} &= Z_2 \\
 A_{21} &= Y_1 + Y_3 + Y_1 Z_2 Y_3 & A_{22} &= 1 + Y_1 Z_2
 \end{aligned}$$

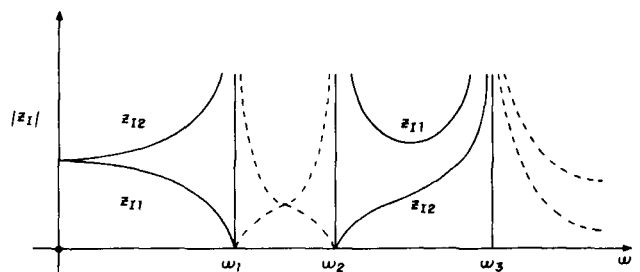

fig. 4. Image impedances at input and output ports as functions of frequency. Frequency is denoted as  $\omega = 2\pi f$ . Dashed lines indicate a negative-real-part image impedance.

Synthesis of component values is not possible between  $\omega_1$  and  $\omega_2$  nor above  $\omega_3$  because of the negative real parts of the impedance. The only choice is below  $\omega_1$  or between  $\omega_2$  and  $\omega_3$ .

### center frequency

### impedance transformation

Assuming that  $R1$  is greater than  $R2$  will exclude any frequency condition below  $\omega_1$ . The range between  $\omega_2$  and  $\omega_3$  is left and shown expanded in fig. 5.

Frequency  $\omega_0$  is the geometric mean of  $\omega_2$  and  $\omega_3$ , expressed as:

$$\omega_0 = \sqrt{\omega_2 \omega_3} \quad (3)$$

The intersection of  $\omega_0$  and each image impedance plot line will give  $R1 = Z_{I1}$  and  $R2 = Z_{I2}$ . Frequency  $\omega_0$  is the network center frequency.

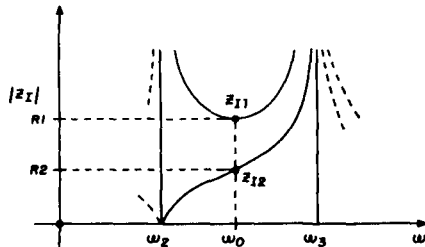

fig. 5. Impedance-transformation relationship to geometric center frequency,  $\omega_0$ , which is the geometric mean of  $\omega_2$  and  $\omega_3$ . Note that  $Z_{I1}$  has the least change at  $\omega_0$ .

Holding to the network center frequency,  $\omega_0$ , the susceptances and reactances of each pi-network arm are defined as:

$$A_0 = \omega_0 C1 \quad (4)$$

$$B_0 = \omega_0 L \quad (5)$$

$$E_0 = \omega_0 C2 \quad (6)$$

Each end resistance can then be related to all component values by substituting eqs. 4, 5, and 6 into eqs. 1 and 2:

$$R1^2 = \frac{B_0(B_0 E_0 - 1)}{(A_0 B_0 - 1)(A_0 + E_0 - A_0 B_0 E_0)} \quad (7)$$

$$R2^2 = \frac{B_0(A_0 B_0 - 1)}{(B_0 E_0 - 1)(A_0 + E_0 - A_0 B_0 E_0)} \quad (8)$$

Defining a ratio,  $m$ , as  $R1$  divided by  $R2$ , an identity is obtained from eqs. 7 and 8:

$$m = \frac{R1}{R2} = \frac{B_0 E_0 - 1}{A_0 B_0 - 1} \quad (9)$$

The relationship of  $\omega_2$  and  $\omega_3$  frequencies must now be established.

### optimizing the design-center frequency

Examination of fig. 5 shows that  $Z_{I1}$  has the least change of value at  $\omega_0$ . This can be proved by taking the derivative of  $Z_{I1}$  as a function of frequency with eq. 1.  $Z_{I2}$  has a relatively constant slope at  $\omega_0$ . Choosing  $\omega_0$  as the design center frequency results in a minimum impedance change at each network port over a given bandwidth.

To find  $\omega_0$  from eq. 3, cut-off frequencies  $\omega_2$  and  $\omega_3$  must be found. Image impedance plots in figs. 4 and 5 will show that  $Z_{I1}$  goes to infinity at each fre-

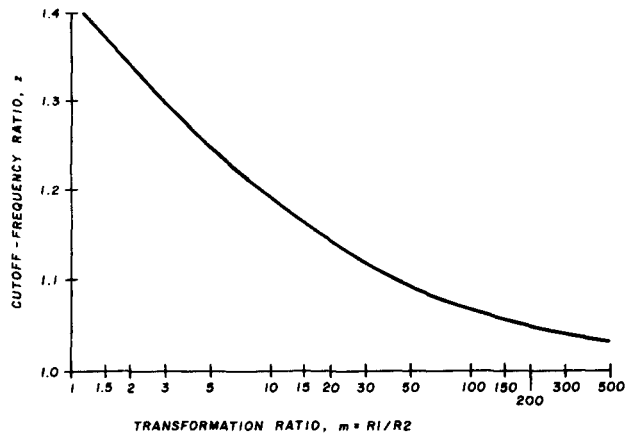

fig. 6. Cutoff frequency ratio,  $z$ , as a function of transformation ratio,  $m$ . Note that  $z$  is an inverse function of  $m$ . A lower resistance ratio will provide greater matching bandwidth; a higher resistance ratio gives a narrow bandwidth.

quency and  $Z_{I2}$  is zero at  $\omega_2$  and infinity at  $\omega_3$ . Examination of eq. 1 shows that the denominator becomes zero if  $AB = 1$ . A zero denominator will yield a result of infinity. Similarly, the numerator of eq. 2 will be zero if  $AB = 1$ . A relationship to  $\omega_2$  now exists, and from the expressions in fig. 3:

$$\omega_2^2 = \frac{1}{C1L} \quad (10)$$

Both image impedances are infinity at  $\omega_3$ . This condition will result if the term  $(A + E - ABE)$  is zero or  $(A + E) = ABE$ . This term is common to eqs. 1 and 2. Using the expressions in fig. 3,

$$\omega_3^2 = \frac{C1 + C2}{C1LC2} \quad (11)$$

Eqs. 10 and 11 are a bit clumsy to handle directly. It

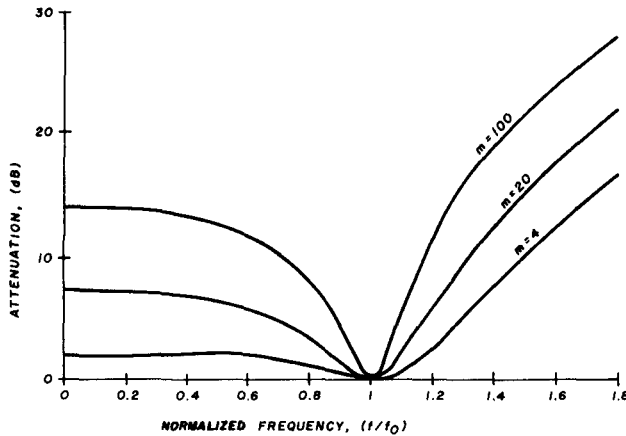

fig. 7. Normalized attenuation characteristic for various transformation ratios. Curves illustrate the difference in response caused by transformation ratio  $m$ .

will be easier to handle if another ratio is used:

$$z = \frac{\omega_3}{\omega_2} \quad (12)$$

Some algebraic manipulation of eqs. 3 through 6 and 12 result in the identities

$$z = A_0 B_0 = \sqrt{\frac{A_0 + E_0}{E_0}} \quad (13)$$

### normalizing the component values

More algebraic manipulation using eqs. 4, 5, 6; 9 through 11; and 13 give the following relationships:

$$A_0 = \frac{\sqrt{m(z+1)}}{R1} \quad \text{and} \quad C1 = \frac{\sqrt{m(z+1)}}{\omega_0 R1} \quad (14)$$

$$B_0 = \frac{z R1}{\sqrt{m(z+1)}} \quad \text{and} \quad L = \frac{z R1}{\omega_0 \sqrt{m(z+1)}} \quad (15)$$

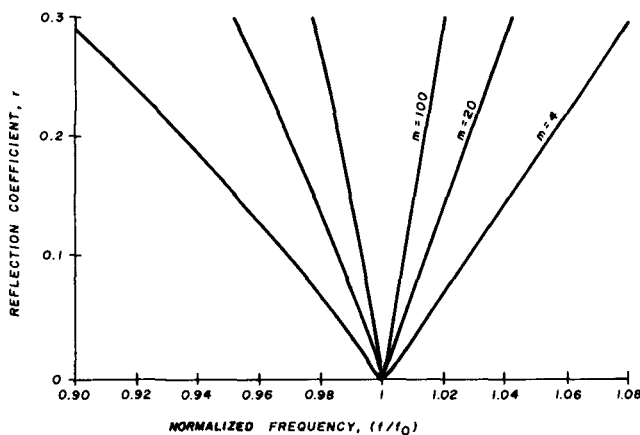

fig. 8. Normalized reflection characteristic for various transformation ratios. Best operation occurs when reflection coefficient  $r < 0.1$ .

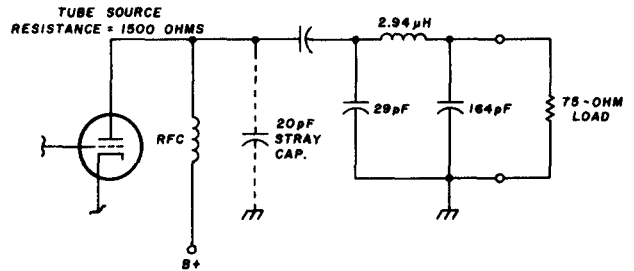

fig. 9. Pi net example for a tube amplifier. Frequency range is between 13.9-14.4 MHz. The reflection coefficient can be checked against fig. 8 for the band edges.

$$E_0 = \frac{1}{R2(z-1)\sqrt{m(z+1)}} \quad (16)$$

$$\text{and } C2 = \frac{1}{\omega_0 R2(z-1)\sqrt{m(z+1)}}$$

Cutoff frequency ratio,  $z$ , can't be selected arbitrarily. It has a definite relationship to end-resistance/transformation ratio  $m$ . Using eqs. 9 and 13 through 16, this is:

$$z^2 - z^2[(m-1)/m] - z[(m+1)/m] + [(m-1)/m] = 0 \quad (17)$$

Fig. 6 is a plot of cutoff frequency ratio,  $z$ , versus transformation ratio,  $m$ . Eq. 17 is valid only for  $m$  greater than unity and  $R1$  greater than  $R2$ .

Note that  $z$  is inversely proportional to  $m$ . A lower resistance ratio will give a greater matching bandwidth; a higher resistance ratio gives a narrow bandwidth. A check on bandwidth is possible by direct analysis of a network versus frequency, but it may be easier to test by mathematical means.

### transfer functions and properties

A *transfer function* is a mathematical expression of a network that allows comparison of input to output vs. frequency. It can also be used to find the *reflection coefficient* at the input port as a check of matching bandwidth. This reflection coefficient is the same as that of a loaded transmission line VSWR expression.

The common transfer function,  $F(\Omega)$ , representing available generator power versus output power, may be expressed in the normalized form for the pi network as:

$$F(\Omega) = \left( \frac{1}{2\sqrt{m}} \right) \left[ A_{11} + \frac{A_{12}}{R2} + A_{21}R1 + A_{22}m \right] \\ = G + jU = \sqrt{\frac{P_0}{P_2}} = \frac{E_g}{2E_{out}\sqrt{m}} \quad (18)$$

where  $A_{11}$ ,  $A_{12}$ ,  $A_{21}$ ,  $A_{22}$  are the matrix terms given previously and

$\Omega = \omega/\omega_0$ , ratio of calculation versus center frequency

$G =$  real part of  $F(\Omega)$

$U =$  imaginary part of  $F(\Omega)$

$P_o =$  available power of generator,  $R_1$

$P_2 =$  power absorbed by  $R_2$

The transfer function,  $F(\Omega)$ , may be expressed in terms of  $\Omega$ ,  $z$ , and  $m$  by:

$$F(\Omega) = \frac{1}{2\sqrt{m}} \left[ \frac{m(z^2 - 1)(1 - \Omega^2 z) + z^2 - \Omega^2 z - 1}{z^2 - 1} + j \frac{\Omega z(2z - \Omega^2 - 1)\sqrt{m(z+1)}}{z^2 - 1} \right] \quad (19)$$

The term  $\frac{1}{2\sqrt{m}}$  is the normalizing factor. Any combination of  $z$  and  $m$  will result in unity magnitude of  $F(\Omega)$  at  $\omega_0$ ; this allows a response comparison without scale shifting.

Eq. 19 may be programmed on a calculator but must be converted to polar form.\* Taken directly, the term in brackets of the normalized transfer function is the generator voltage of fig. 1 divided by the complex output voltage across  $R_2$ . The ratio of complex-output-voltage-to-complex-input-voltage of the network is the inverse of  $F(\Omega)$ , with the result multiplied by  $1/2$ .

Normalized attenuation around design center frequency can be expressed by:

$$e^{2\alpha} = |F(\Omega)|^2 = G^2 + U^2 \quad (20)$$

This response is plotted in fig. 7 showing attenuation as a function of design center frequency. Attenuation in dB is  $20 \log_{10}(e^\alpha)$ . This plot illustrates clearly the difference in response caused by transformation ratio  $m$ .

Reflection coefficient,  $r$ , is the reflected voltage

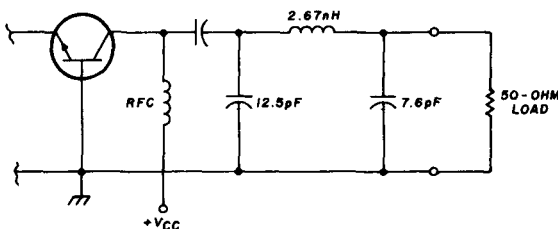

fig. 10. Example showing a transistor amplifier in the range of 1215-1300 MHz. Transistor output impedance is resistive at 12.5 ohms across the frequency band;  $R_1$  is now the load and  $R_2$  is the generator.

\*A rectangular-form expression is usually easier to show in texts. The problem with such expressions is that the complex real part becomes negative! Conversion to polar form gives a positive magnitude with the correct phase angle.

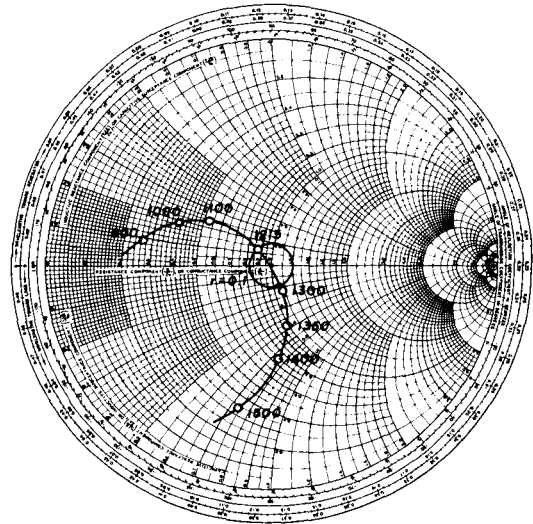

fig. 11. Smith chart showing network output impedance of a transistor amplifier and pi network. Output VSWR is less than 1.25 across the desired bandwidth.

divided by the forward voltage at the generator. Normalized reflection coefficient can be derived from eqs. 19 and 20:

$$r = \sqrt{\frac{e^{2\alpha} - 1}{e^{2\alpha}}} \quad (21)$$

This expression is plotted in fig. 8 for  $m$  values of 4, 20, and 100. Best operation occurs when  $r$  is less than 0.1. Bandwidth again depends on transformation ratio.

### some examples

A vacuum-tube amplifier has an output impedance of 1500 ohms with stray capacitance of 20 pF. It is to be matched to a 75-ohm line over the range of 13.9-14.4 MHz. The geometric center of the range will be the design center frequency:

$$f_0 = \sqrt{13.9 \times 14.4} = 14.15 \text{ MHz}$$

$R_1$  is 1500,  $R_2$  is 75; so the transformation ratio,  $m$ , equals 20. From fig. 6,  $m = 20$ ;  $z = 1.14$ . Eqs. 14, 15 and 16 give the component values after calculation of some common terms:

$$\omega_0 = 2\pi f_0 = 6.283 \times 14.15 \times 10^6 = 88.91 \times 10^6$$

$$\sqrt{m(z+1)} = \sqrt{20 \times 2.14} = 6.542$$

From eq. 14:

$$C_1 = \frac{6.542}{88.91 \times 10^6 \times 1500} = \frac{6.542}{133.4 \times 10^9} = 49.06 \text{ pF}$$

Subtracting the 20-pF stray capacitance gives a component value of 29.06 pF. From eq. 15,

$$L = \frac{1.14 \times 1500}{88.91 \times 10^6 \times 6.542} = \frac{1.710 \times 10^3}{581.6 \times 10^6} = 2.940 \text{ } \mu\text{H}$$



From eq. 16:

$$C2 = \frac{1}{88.91 \times 10^6 \times 75 \times 0.14 \times 6.542}$$

$$= \frac{1}{6.107 \times 10^9} = 163.7 \text{ pF}$$

The tube and network circuit is shown in fig. 9. The cutoff frequencies,  $\omega_2$  and  $\omega_3$ , can be checked with eqs. 10 and 11 as 13.25 MHz and 15.11 MHz respectively.

The reflection coefficient can be checked against fig. 8 for the band edges. The high end is 14.4/14.15 or 1.018 relative to center; low end is 13.9/14.15, or 0.982. The reflection coefficient is approximately 0.12, or 12 per cent.

Another example is a microwave amplifier output circuit (fig. 10). The desired range is 1215-1300 MHz. The transistor must match a 50-ohm load. The transistor output impedance is resistive at 12.5 ohms across the band;  $R1$  is now the load and  $R2$  the generator end. The design center frequency is:

$$f_0 = \sqrt{1215 \times 1300} = 1257 \text{ MHz}$$

Transformation ratio is 50/12.5 or 4, and  $z$  is 1.27 (from fig. 6). Remembering that  $C2$  is next to the generator and  $C1$  next to the load, eqs. 14, 15, and 16 give the following values:

$$C1 = 7.63 \text{ pF}, L = 2.67 \text{ nH}, C2 = 12.45 \text{ pF}$$

A Smith-chart plot of the network output impedance, normalized to 50 ohms, is given in fig. 11. Output VSWR is less than 1.25 across the desired bandwidth.

## group delay and element dissipation

Group delay is the differential phase delay divided by the differential frequency across the desired band. It is the time delay of a signal through the network

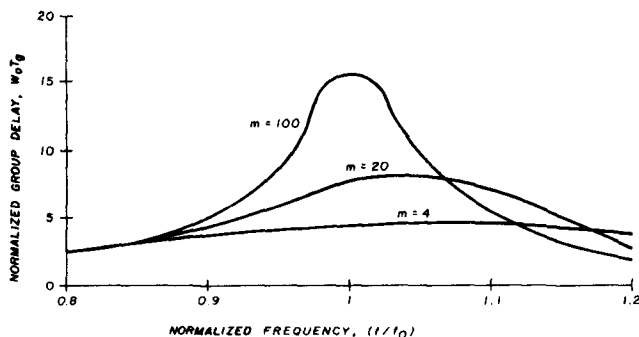

fig. 12. Normalized group delay for three transformation ratios,  $m$ .

and is important for wideband modulation transmission and determination of network dissipation loss. Normalized group delay,  $\omega_0 T_g$ , can be determined from the complex transfer function of eq. 19 as:

$$\omega_0 T_g = \frac{\left(\frac{dU}{d\Omega}\right) G - \left(\frac{dG}{d\Omega}\right) U}{G^2 + U^2} \quad (22)$$

Normalized group delay for three values of  $m$  is plotted in fig. 12. In general, maximum group delay occurs at rapid attenuation versus frequency.\* The pi-network maximums are slightly higher than design center frequency.

Network attenuation other than the transformation ratio is determined by the unloaded  $Q$  of each reactive element. Knowing the element  $Q$  allows determination of loss through the normalized group-delay expression:

$$a_v = \text{loss (in dB)} = \frac{4.343 \omega_0 T_g}{Q_u} \quad (23)$$

Eq. 23 is assisted by the design-center-frequency normalized group delay plotted in fig. 13. Assuming

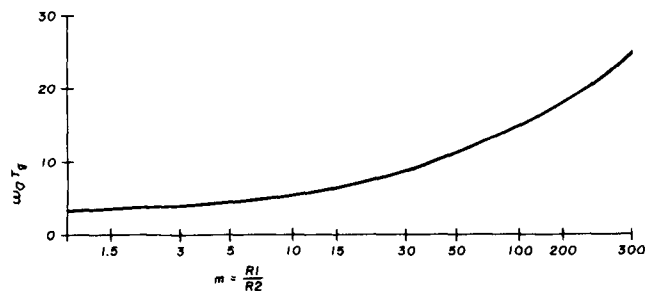

fig. 13. Normalized group delay at center frequency for various transformation ratios.

very high unloaded  $Q$ s of the capacitors, an unloaded  $Q$  of 160 for the inductor, and an  $m$  of 20 (from the first example), additional network loss will be 0.20 dB, a negligible amount.

## summary

The optimum design of a pi network depends on the transformation ratio. Bandwidth is inversely proportional to this ratio. Simple calculation of components is possible with the aid of a few graphs. Reflection coefficient is proportional to transformation ratio and may be used to determine if a network must be retuned for a particular bandwidth.

\*Phase shift through a filter is responsible; all filters have rapid phase changes as amplitude response moves from passband to stopband regions.

## a note on the appendix

Appendix A was included in Mr. Leonard H. Anderson's rewritten version of this article. It discusses the "image impedance" method of network design with respect to matrix notation. Also included are normalized component values and their relationships with respect to eqs. 14, 15, and 16 as well as an explanation of transfer functions with regard to the derivation of eqs. 19, 20, and 22.

Author DL9LX, in his original version of this article, furnished other appended material. This includes a listing of computed pi-network elements as a function of impedance-transforming ratios for various center frequencies (Appendix B); computed values of  $z = f(m)$  from eq. 17 (Appendix C); and a table of normalized network elements for various transformation ratios useful in general network design (Appendix D).

Interested readers may obtain a copy of author DL9LX's appendices from *ham radio* upon receipt of a large self-addressed, stamped envelope with 28 cents postage. The material in these appendices is in the author's original notation.

Editor.

## references

1. George L. Matthaei, Leo Young, and E.M.T. Jones, *Microwave Filters, Impedance-Matching Networks, and Coupling Structures*, McGraw-Hill Book Company, 1964.
2. S.B. Cohn, "Dissipation Loss in Multiple-Coupled-Resonator Design Filters," *Proceedings of the IRE*, August, 1959.
3. H.F. Mayer, "Über die Dämpfung von Siebketten im Durchlässigkeitsbereich," E.N.T., 1925, Band 2.
4. William I. Orr, W6SAI, "Linear Amplifier Design, Part II," *ham radio*, July, 1979.

## bibliography

Temes and Mitra, *Modern Filter Theory and Design*, John Wiley and Sons, 1973.

## appendix A

### image impedance

Modern network theory tends to ignore the "image method" of design. While image methods may be disregarded for complicated structures, they are valid for simple networks and quite useful at frequencies where it's difficult to obtain a purely resistive load.

Many readers will be unfamiliar with network matrix notation. Those who are familiar may be more acquainted with "A, B, C, D" notation instead of the subscripted form. Open and short-circuit impedances are given below, referred to fig. 3.

Port 1 input impedance with port 2 open:

$$Z_{o1} = \frac{Z_2 Y_3 + 1}{Y_1 Z_2 Y_3 + Y_1 + Y_3}$$

Port 1 input impedance with port 2 shorted:

$$Z_{s1} = \frac{Z_2}{Y_1 Z_2 + 1}$$

Port 2 input impedance with port 1 open:

$$Z_{o2} = \frac{Y_1 Z_2 + 1}{Y_1 Z_2 Y_3 + Y_1 + Y_3}$$

Port 2 input impedance with port 1 shorted:

$$Z_{s2} = \frac{Z_2}{Z_2 Y_3 + 1}$$

Multiplication of  $Z_{o1}$  and  $Z_{s1}$  or  $Z_{o2}$  and  $Z_{s2}$  will still give the same result as with matrix notation. The fact that each image impedance expression, while complex, results in an imaginary part of zero comes about by completing the complex division; this can be verified by completing all steps. This also applies to eqs. (7) and (8). Real-part-only complex expressions are common to purely reactive networks.

Image impedances show the individual resonances within the network. They are synthesis tools — not an actual input impedance when loaded. The "missing" expression for network resonance at  $\omega_1$  of fig. 4 is because of the  $(BE - I)$  term of eqs. (1) and (2), where:

$$\omega_1^2 = 1/(C_2 L)$$

### normalized component values and relationships

Eqs. (14), (15), and (16) could have been expressed without the frequency ratio,  $z$ . In fact,  $z$  could have been omitted, but at a price: the usable bandwidth would not be optimized, since the design center frequency could not be located for minimum reflection coefficient, or "goodness of match."

Many readers are under the false assumption that a pi network is a resonant circuit with a quality factor,  $Q$ . It is simply an impedance transformation network with the appearance of resonance due to the sharp cutoff above design frequency. Low-side response behaves more like a conventional asymmetrical lowpass with varying passband response. Since many power amplifiers are still tube types with pi networks, transformation ratios will be high and the network will appear to peak at center frequency. As high-frequency, high-power semiconductor technology improves, transformation ratios will decrease, and the pi network will be treated as the simple lowpass filter it really is.

### transfer functions

Eq. (18) may be found in reference 1, page 37, equations (2.10-1) and (2.10-5), using ABCD matrix descriptors. The transfer function is the generator-voltage-to-load-voltage ratio. The normalizing term will yield "available voltage" at the load; that is, all power from the generator is assumed dissipated in the load,  $RI$ ; none in source resistance,  $RI$ .

Eq. (19) is obtained by substitution of the network arm reactances into eq. (18). The steps of substitution and simplification are too long to be included here; they have been checked independently.

Input/output complex voltage ratio is obtained by deletion of (1/2) from the normalizing term. This yields a condition in which the generator is a constant-current source with a source conductance always present at the network input.

More detail on the attenuation and delay functions may be found in reference 1, sections 3.02 and 3.03. These use the image propagation function,  $\gamma$ , expressed in general terms as:

$$\gamma = \alpha + j\beta = \ln(\sqrt{A_{11}A_{22}} + \sqrt{A_{12}A_{21}})$$

where  $\alpha$  = image attenuation in nepers

$\beta$  = image phase in radians

Eq. (20) is derived by manipulation of this basic expression in terms of eq. (19). Normalized group delay, eq. (22), is derived from the basic group delay expression

$$T_g = \frac{d\beta}{d\omega} = \left( \frac{d\beta}{d\Omega} \right) \left( \frac{d\Omega}{d\omega} \right)$$

With the partial differential  $d\Omega/d\omega = 1/\omega_0$ ,

$$\omega_0 T_g = \frac{d\beta}{d\Omega}$$

which yields eq. (22) in terms of eq. (19).

ham radio

## Amateur Radio

Just getting started? This book is ideal for you. It will help you get your first license. Or if you already have your ticket, the book will serve as your handy station manual. Written by Bill Lowry, W1VV, it includes a brief description of major activities, equipment and procedures to help the new ham decide where to begin, what equipment to buy initially, and how to make contacts with other hams after the station is assembled. Most importantly, this book tells the beginner how to study for the test, and presents the facts that must be learned in order to pass the written part of the exam. It includes complete FCC rules and official study guide for all license classes. Also included is a colorful call-area wall map.

Just \$6.95

• *Amateur Radio Poster.* Add this beautiful poster to your amateur radio station. Rich-in-color lithograph is produced from artwork shown on Amateur Radio book. Suitable for framing.

Just \$3.50

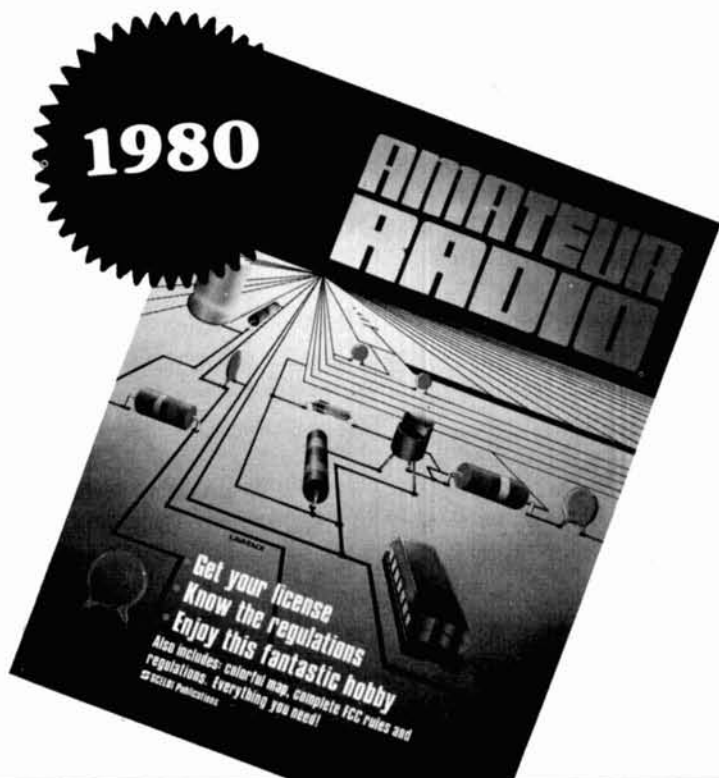

# LOOKING FOR A SPECIAL BOOK?



## Practical Antennas for the Radio Amateur

Brand new antenna book in a new easy-to-read format with big diagrams. You've never seen an antenna book quite like this! Written by well-known author, Robert Myers, W1XT, it tells you how to choose, use and build your antenna system. Here's what you get: How to build practical beams, quads and wire antennas . . . Computer-generated beam headings to every known country in the world . . . Charts and tables to eliminate tricky calculations . . . Practical ideas for the newcomer . . . OSCAR antennas . . . Complete bibliography of magazine articles on antennas . . . Antenna safety . . . Trick antennas for portable work . . . Tips on how to keep your antenna up. Durable vinyl cover. *Only \$9.95*

### Ham Radio's Bookstore

Greenville, NH 03048

Amateur Radio     Poster     Practical Antennas

Name \_\_\_\_\_

Street \_\_\_\_\_

City \_\_\_\_\_ State \_\_\_\_\_ Zip \_\_\_\_\_

Please enclose proper amount for books plus \$1.00 shipping or credit card information.

**Order NOW!!**

# regulated power supply for VHF transceivers

Many of today's 2-meter fm transceivers feature 25 watts (or less) of rf power. When used in the home station, these radios generally require 13.8 Vdc at 7-8 amperes. Since I didn't have a power supply of this capacity, the only solution was to build one!

Simplicity is reliability, so I decided that the circuit couldn't be complicated; but good regulation was a requirement. The circuit shown in fig. 1 features no-load-to-full-load (8.0 amperes) regulation of 0.2 Vdc. Also featured in the circuit is "fold back" current limiting and overvoltage protection.

ton pair. The output voltage (in this case 13.8 Vdc) is set by potentiometer R1. This sampled voltage is applied to U1, a UA723HM voltage regulator, which contains a voltage reference amplifier and an error amplifier. U1 output is applied to Q2 base to adjust the voltage at R1 to its proper value. The low-value resistor, R2, is the current "fold-back limiter." If the power-supply output should exceed 10 amperes (i.e., a short circuit), regulator U1 will bias the transistors to cutoff; thus the output voltage will drop to near zero until the short circuit condition is corrected.

Capacitor C1 and OVP form an over-voltage-protection circuit. The OVP limits the maximum output

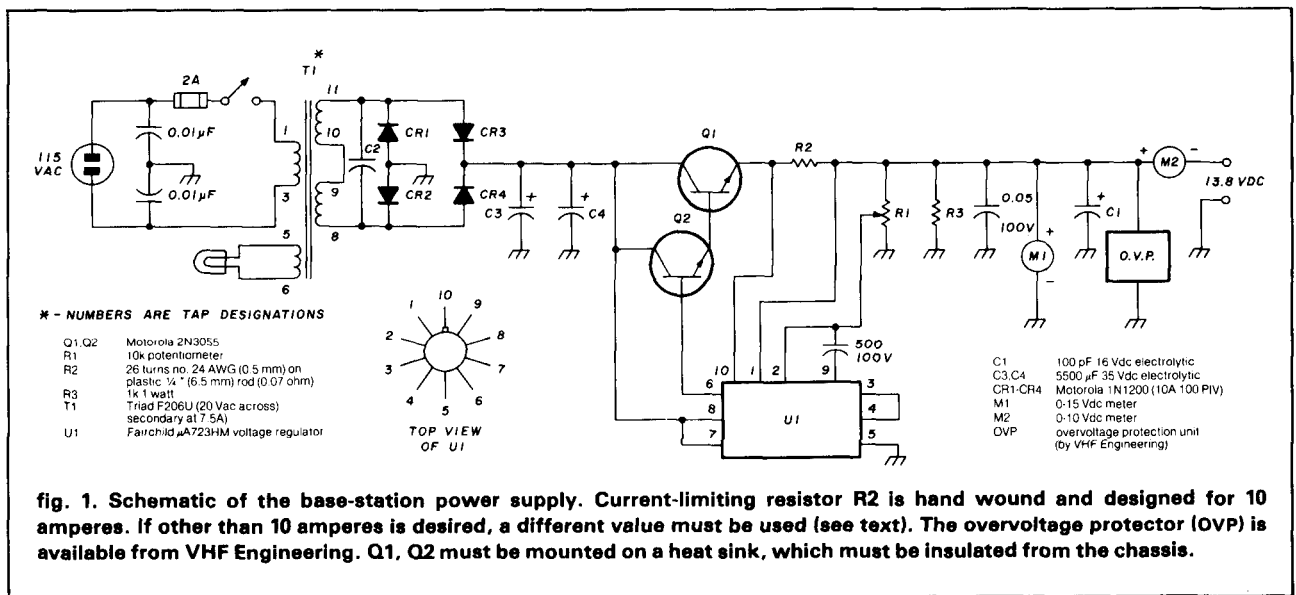

## circuit description

The power supply consists of a full-wave bridge rectifier with capacitor input. Any transformer-capacitor combination that produces 28 volts dc at 7.5 amperes at Q1 collector will work. Voltage at Q1 collector should not be greater than 40 Vdc, otherwise damage to U1 may result. Q1 and Q2 form a Darling-

voltage to + 15 Vdc. (The OVP unit is available from VHF Engineering.) The voltmeter and ammeter are optional, depending on your junk-box supply. The

By Larry Beebe, WA8RXU, 258 Debbie Drive, RD2, Box 519, Gallipolis, Ohio 45631

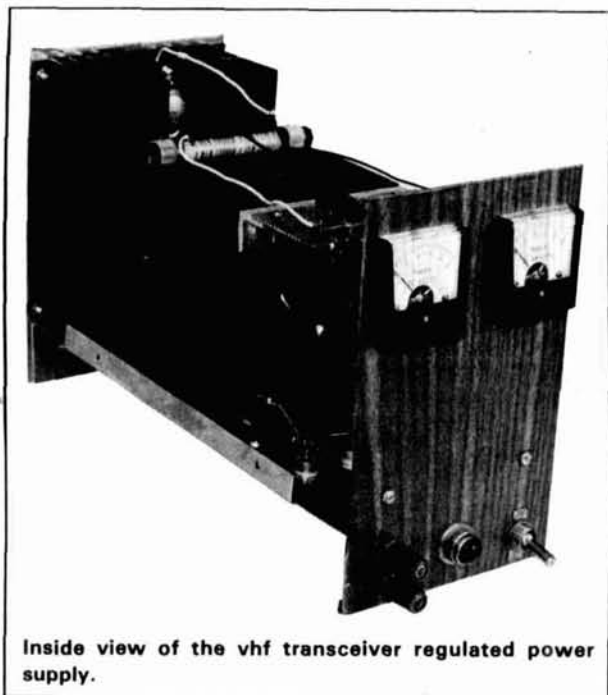

Inside view of the vhf transceiver regulated power supply.

output voltage (determined by R1) is adjustable from about 7-14 Vdc.

### construction details

Component layout isn't critical; there's room for wide variation in this regard. Both Q1 and Q2 must be mounted on a suitable heat sink, which must be insulated from the chassis. "Current foldback" resistor, R2, should be wound on a plastic or Teflon rod of about 1/4 inch (6.5 mm) diameter. Regulator U1 and potentiometer R1 are mounted on a piece of Vector board. If you wish to have the current limited to other than 10 amperes, a different resistor for R2 will have to be wound. To determine the new resistance:

$$R_{limit} = \frac{0.7}{I_{limit}} \quad (1)$$

Where  $R_{limit}$  is the new value resistor (ohms), and  $I_{limit}$  is the maximum desired current (amperes).

### closing comments

Operating results with the power supply have been excellent. If you have a good junk box, or are a good trader at the Hamvention circuits, this supply should cost less than half that of a similar commercial model. Circuit and component layout aren't critical so you have a weekend of fun in constructing your own base-station power supply.

ham radio

State  
of the art



by  
**K.V.G.**

### CRYSTAL FILTERS and DISCRIMINATORS

#### 9.0 MHz FILTERS

XF9-A	2.5 kHz	SSB TX	\$50.60
XF9-B	2.4 kHz	SSB RX/TX	\$68.60
XF9-C	3.75 kHz	AM	\$73.70
XF9-D	5.0 kHz	AM	\$73.70
XF9-E	12.0 kHz	NBFM	\$73.70
XF9-M	0.5 kHz	CW (4 pole)	\$51.55
XF9-NB	0.5 kHz	CW (8 pole)	\$91.35

Export

Inquiries

Invited

Shipping

\$1.75

per filter

#### 9.0 MHz CRYSTALS (Hc25/u)

XF900	9000.0 kHz	Carrier	\$5.95
XF901	8998.5 kHz	USB	\$5.95
XF902	9001.5 kHz	LSB	\$5.95
XF903	8999.0 kHz	BFO	\$5.95
F-05	Hc25/u	Socket Chassis	.50
F-06	Hc25/u	Socket P.C. Board	.50

## ANTENNAS

### UHF LOOP YAGIS

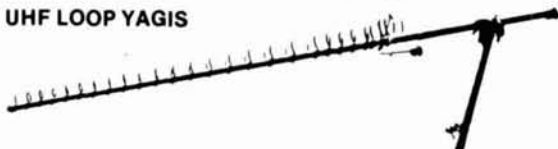

26 LOOPS	GAIN + 20 dBi		
1250-1340 MHz	1296-LY	TYPE N CONNECTOR	\$59.70
1650-1750 MHz	1691-LY	TYPE N CONNECTOR	\$64.70



### 420-450 MHz MULTIBEAMS

48 EL.	GAIN + 15.7 dBd	70/MBM48	\$69.95
88 EL.	GAIN + 18.5 dBd	70/MBM88	\$95.95

### 144-148 MHz J-SLOTS

8 OVER 8 HORIZONTAL POL.	+ 12.3 dBd	D8/2M	\$55.95
8 BY 8 VERTICAL POL.		D8/2M-VERT.	\$65.60
8 + 8 TWIST 8XY/2M			\$57.75



### ANTENNAS

(FOB CONCORD, VIA UPS)

## RECEIVE CONVERTERS



MODELS FOR ALL BANDS 50 MHz  
THRU 1296 MHz. LOW NOISE OP-  
TIONS AT 432 MHz.

Send 30¢ (2 stamps) for full details of KVG crystal products and all your VHF & UHF equipment requirements.

Pre-Selector Filters  
Varactor Triplers  
Decade Pre-Scalers  
Antennas

Amplifiers  
Crystal Filters  
Frequency Filters  
Oscillator Crystals

SSB Transverters  
FM Transverters  
VHF Converters  
UHF Converters



**si**

**Spectrum  
International, Inc.**  
Post Office Box 1084  
Concord, Mass. 01742, USA

# counter mixer

## for the Kenwood TS-520-SE transceiver

This interface circuit  
between your  
transceiver and counter  
provides high accuracy

Most of the digital readout Amateur equipment available today is accuracy-specified to the nearest 100 Hz. This may mean plus or minus 100 Hz, plus or minus the time-base accuracy, and it may include programmed beat frequency oscillator (BFO) allowances. In this case the BFO output is not actually counted, and accuracy will suffer from tolerances of the BFO crystals. Because of linearity problems with the mechanical dial, the digital system will probably be more accurate across the dial, but just barely.

I've used the system described here in various forms and with different gear for the past eight years. It involves mixing the transceiver's three oscillator outputs to produce the operating frequency.<sup>1</sup> To measure the frequency of an incoming carrier, the low i-f is amplified and limited, then substituted for the BFO oscillator output in the mixing scheme. This option is useful for frequency-measuring tests and to calibrate the frequency counter used as a readout by checking WWV.

This particular unit (fig. 1) is for use with a Kenwood TS-520-SE. This transceiver has the oscillator outputs as well as a dc-supply connection available on the back panel. To provide an i-f output, another phono jack is installed on the back panel and an emit-

ter follower is used to bring out a tap to the i-f board. See fig. 2.

### description

Use of this unit with other gear would require providing the proper oscillator, i-f, and power-supply connections. If the rig uses a different mixing scheme, the bandpass circuit between mixers will have to be changed to the new high i-f. Also the input and output coils on the low i-f amplifier and limiter stage will need to be resonated to the different low i-f. The Heath SB-102, for instance, uses the same mixing scheme, and the same coils and capacitors may be used. The six output circuits remain the same, one for each band.

Doubly balanced mixers attenuate unwanted outputs. Separate bandpass circuits cover each frequency range. The 14-15.6-MHz range is covered by one filter as is the entire 10-meter band.

After the bandpass circuits have selected the desired bands, a two-stage broadband amplifier brings up the level to operate a frequency counter.<sup>2</sup> The bandpass circuits are calculated for an  $R$  of 10,000 ohms and were designed after an article by Anderson.<sup>3</sup> The requirements in this application are not strict. The filter caps were changed to the nearest standard value.

### construction

Use good shielding to avoid feedback of the output signal to the receiver input. When used in the signal-measuring mode, feedback is more likely to occur. To operate in this mode, the two isolation amplifiers are necessary to prevent signals from entering the receiver on the heterodyne- and tuning-oscillator cables. Another source of feedback is the frequency counter. The counter should be enclosed in a metal case to prevent radiation of the high-level

By E.R. Lamprecht, W5NPD, Route 3, Box 207, Victoria, Texas 77901

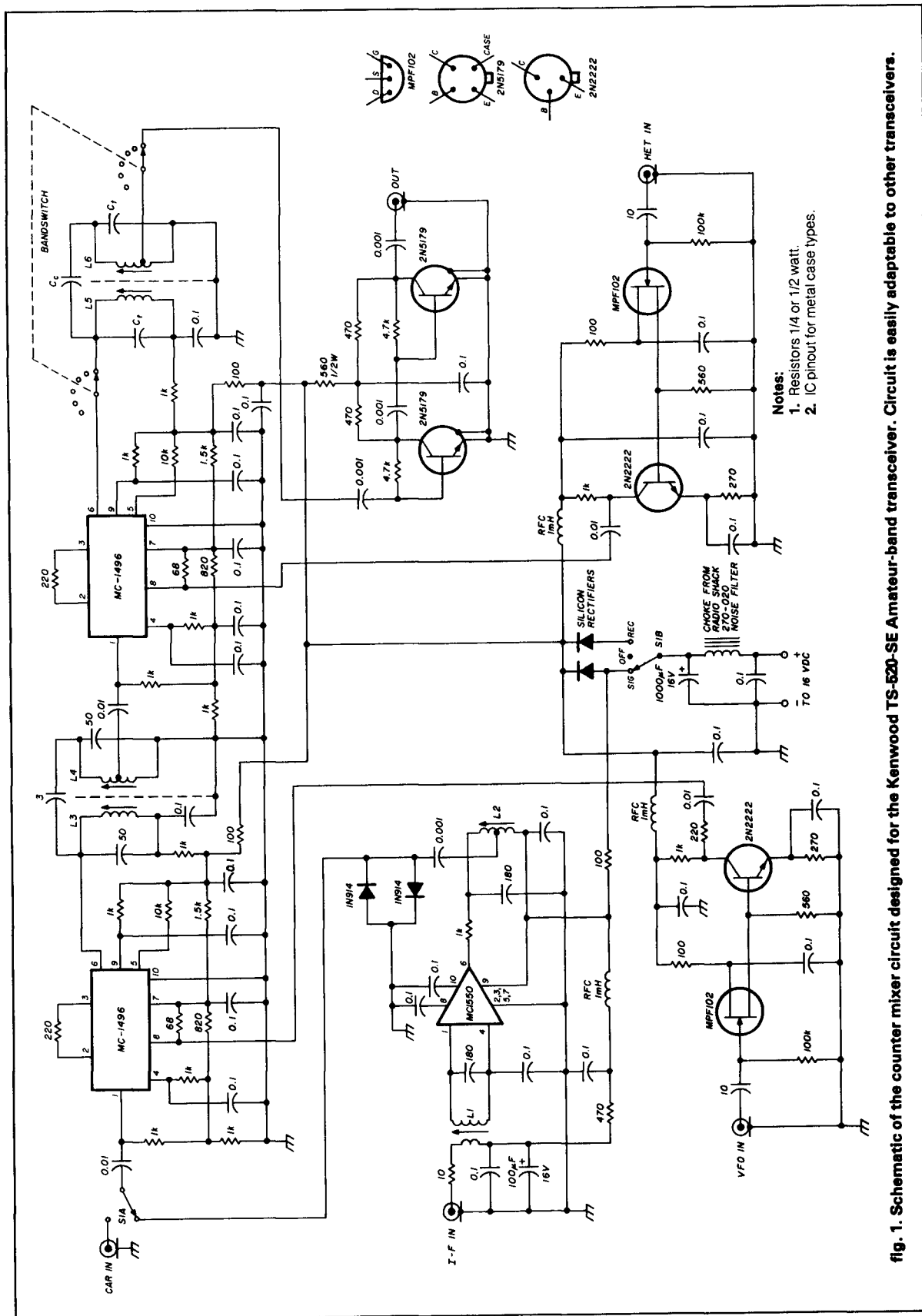

fig. 1. Schematic of the counter mixer circuit designed for the Kenwood TS-520-SE Amateur-band transceiver. Circuit is easily adaptable to other transceivers.

signals in its input circuits. A short cable between the counter and the mixing unit is helpful, as is a short direct chassis-to-chassis connection between all units.

If you need the unit only as a digital readout of the operating frequency, the isolation amplifiers, i-f amplifier, mode switch, and the i-f connection to the transceiver may be omitted.

## operation

When in the operating-frequency mode, the readout changes as the dial is moved. In the signal mode, the readout indicates the frequency of a carrier as long as it is in the passband and of sufficient strength. An S-1 signal will register in the absence of interfering signals. As an example, tuning across WWV results in an unchanging 15 000 000 on the counter. Of course, fading and multipath distortion will alter the reading for some count periods. The counter will count what it sees, and the receiver must provide a countable signal. To help ensure a clean count the receiver should have a CW filter to narrow the passband and separate modulation from the carrier. However, the system will work well with an SSB filter, especially on WWV.

## tune up

The following procedure is for use with the Kenwood TS-520-SE transceiver.

1. Set mode switch to RECEIVE.
2. Adjust L3, L4 (fig. 1) for maximum signal at pin 1 of the second mixer (MC1496) with the transceiver tuned to about band center.
3. Adjust L5, L6 on each band for proper counter operation. Make small adjustments to allow coverage of the entire band. Observation of the counter is probably the best indication of proper tuning.
4. Set mode switch to SIGNAL.
5. Tune in a steady signal, such as that from the calibrator. Adjust L1, L2 for maximum output at the tap on L2. Reduce signal strength as needed to allow peak tuning.

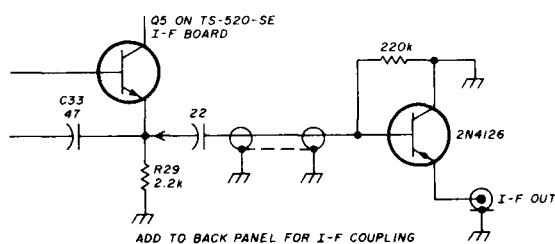

fig. 2. Emitter-follower circuit added to the back panel of the Kenwood TS-520-SE transceiver for i-f signal coupling.

table 1. Coil data for the counter mixer circuit in fig. 1

band (MHz)	L5-L6	L6 tap from bottom (turns)	C <sub>i</sub> (pF)	C <sub>c</sub> (pF)	approximate inductance (μH)
1.8-2.4	no. 32 (0.2 mm) 124 t	10	39	12	109.0
3.5-4.1	no. 32 (0.2 mm) 68 t	6	50	6	32.75
7.0-7.6	no. 32 (0.2 mm) 36 t	3	50	3	8.9
14.0-15.6	no. 30 (0.25 mm) 28 t	3	20	2	5.75
21.0-21.6	no. 30 (0.25 mm) 10 t	1	50	1	1.04
28.0-29.7	no. 30 (0.25 mm) 13 t	1	20	1	1.6
<b>high i-f (MHz)</b>	<b>L3-L4</b>	<b>L4 tap from bottom</b>			
8.295-8.895	no. 32 (0.2 mm) 30 t	7 turns			
<b>low i-f</b>	<b>L1-L2</b>	<b>L2 tap</b>			
3.395	no. 32 (0.2 mm) 42 t	21 turns			

Note: All coils are wound on slug-tuned forms 7/32 inch (5.5 mm) diameter with 1/2 inch (12.5 mm) winding space. Coil is confined to 3/8 inch (9.5 mm) nearest terminals. Windings are layer or scramble wound.

6. As a final check, observe the counter and adjust for readout of the weakest possible signal.

## performance

To give an example of the capabilities of this system, I made sixteen consecutive readings of the WWV carrier at 15 MHz. A count gate time of 100 seconds was used. The readings showed a slow drift above and below the 15-MHz target frequency, with a maximum error of 0.35 Hz. Most likely, the major portion of the error was the result of the oven control, with some error due to propagation delay. The counter is controlled by a 1-MHz crystal in a proportionately controlled oven, which has been on for over five years except for power failures.

Of course I've not approached the point where I can begin to look to WWV as a source of error. But obtaining consistent readings with an error of *less than one part in fifteen million* is quite satisfying.

## references

1. Mac Leish, "A Frequency Counter for the Amateur Station," *QST*, October, 1970.
2. Randall Rhea, WB4KSS, "General-Purpose Wideband rf Amplifier," *ham radio*, April, 1975, pages 58-61.
3. Leonard H. Anderson, "Top-Coupled Bandpass Filter — a Chebyshev Design," *ham radio*, June, 1977, pages 34-40.

ham radio





# the weekender

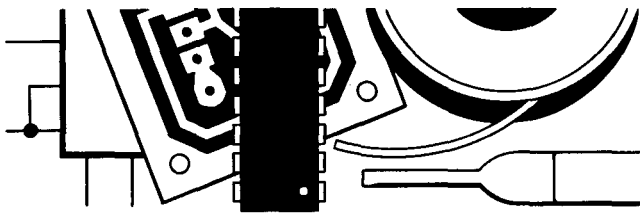

## A simple 40-meter receiver

This article is for those who like to build their own equipment. It is a summary of a solid-state receiver that has performed very well. The receiver is the result of my experience trying to find circuits that work. It's about as simple as you can find. The receiver uses an rf stage, which certainly helps at night when foreign broadcast stations come through on 40 meters.

The most time-consuming part of the project was making the PC boards. I used black PC drafting tape to lay out the boards, which were etched in ferric chloride. Others will probably come up with a better method.

### brief circuit description

Many of the receivers shown in the handbooks don't include an rf stage ahead of the mixer. This receiver was first tried using a double-tuned circuit directly into the mixer. However, the circuit was mounted in the chassis and capacitive coupling wasn't satisfactory. At night the shortwave broadcast stations came through. By using this simple rf stage, the selectivity problem was resolved. You can use whatever toroid forms you can find. The T-80-2 forms are probably too large, but these are what I have used. They have a red core and are about 1 inch (25.5 mm) in diameter. Resonance can be checked by holding a grid-dip oscillator to the hot end or by placing a turn or two of wire around the core and checking with the grid-dip oscillator. The input coil was mounted on the chassis topside and the output coil was mounted underneath. Fig. 1 shows the circuit.

### mixer

The mixer output coil was tuned to 5.5 MHz. It is wound on a 3/8-inch (9.5-mm) ceramic slug-tuned

coil using a fixed 100 pF cap for tuning. L5 (about 13 turns) on the bottom of the coil feeds directly into the Swan crystal filter.

### variable-frequency oscillator

The VFO tunes 12,500-12,800 kHz to cover the 40-meter band. A small cap with two rotary and two fixed plates came out to about 35 pF, which just covers the band. You can pull plates out after the set is going to obtain desired bandspread. Coil L6 was wound on a 3/8-inch (9.5-mm) ceramic slug-tuned coil form. It was wound with silver-plated wire, nylon covered. The two 500-pF caps from the MPF-102 gate to ground are silver micas. A 9-volt zener stabilizes the MPF-102 drain. The two 2N2222 stages are buffers to reduce pulling effect on the VFO and to obtain the 1.5 V rms to feed the mixer.

### i-f stage

Only one i-f stage was necessary for this receiver. L7 is another 3/8-inch (9.5-mm) diameter slug-tuned coil adjusted to 5.5 MHz. It's coupled into the product detector with a 0.001  $\mu$ F cap.

### beat-frequency oscillator

The BFO can be varied about 1 kHz with the 0-30 pF variable cap to adjust the SSB tone. The output coil, L8, is another slug-tuned coil. The 10 pF coupling cap to the product detector should be sufficient, but you can try other values if there isn't enough signal injection.

### construction

I built the receiver starting from the audio stage and worked backward to the front end. I used 2-inch (50-mm) square PC board. I laid out the circuits using black drafting tape and etched the boards with ferric chloride. Parts were mounted on a 7  $\times$  11-inch (178.5  $\times$  280.5-mm) aluminum chassis.\* The VFO was mounted in a partition topside, which was about 3-inches (76.5-mm) square. I used a VTVM and rf probe for tune up.

### performance

I'm amazed at the performance of this little receiver. I frequently operate it from a battery supply during park picnics and wonder how I ever got along without it. Don't ask me how to make a transceiver for CW; so far I've not been able to make a mixer to drive a transmitter section.†

\*Parts that may be useful for construction are available from Radiokit, Box 411H, Greenville, New Hampshire 03048.

†See John Keith's article, "40-Meter Transceiver for Low-Power Operation," *ham radio*, April, 1980, page 12.

By Ed Marriner, W6XM, 528 Colima Street, La Jolla, California 92037

L1 35T NO.26 (0.3mm) TAPPED 10T BOTTOM ON MICROMETALS T-80-2 FORM (RED CORE)  
 L2 3T TAPPED FROM GROUND END OF L1  
 L3 SAME AS L1  
 L4 25T NO.30 (0.25mm) ON 3/8 IN. (9.5mm) CERAMIC FORM  
 L5 13T NO.30 (0.25mm) ON BOTTOM OF L4 (FILTER INPUT)

L6 7T NO.26 (0.3mm) ON 3/8 IN. (9.5mm) CERAMIC FORM  
 L7 25T NO.30 (0.25mm) ON 3/8 IN. (9.5mm) CERAMIC FORM  
 L8 SAME AS L7

NOTES:  
 1. ALL RESISTORS ARE 1/2 WATT  
 2. ALL CAPS 16-25 WVDC

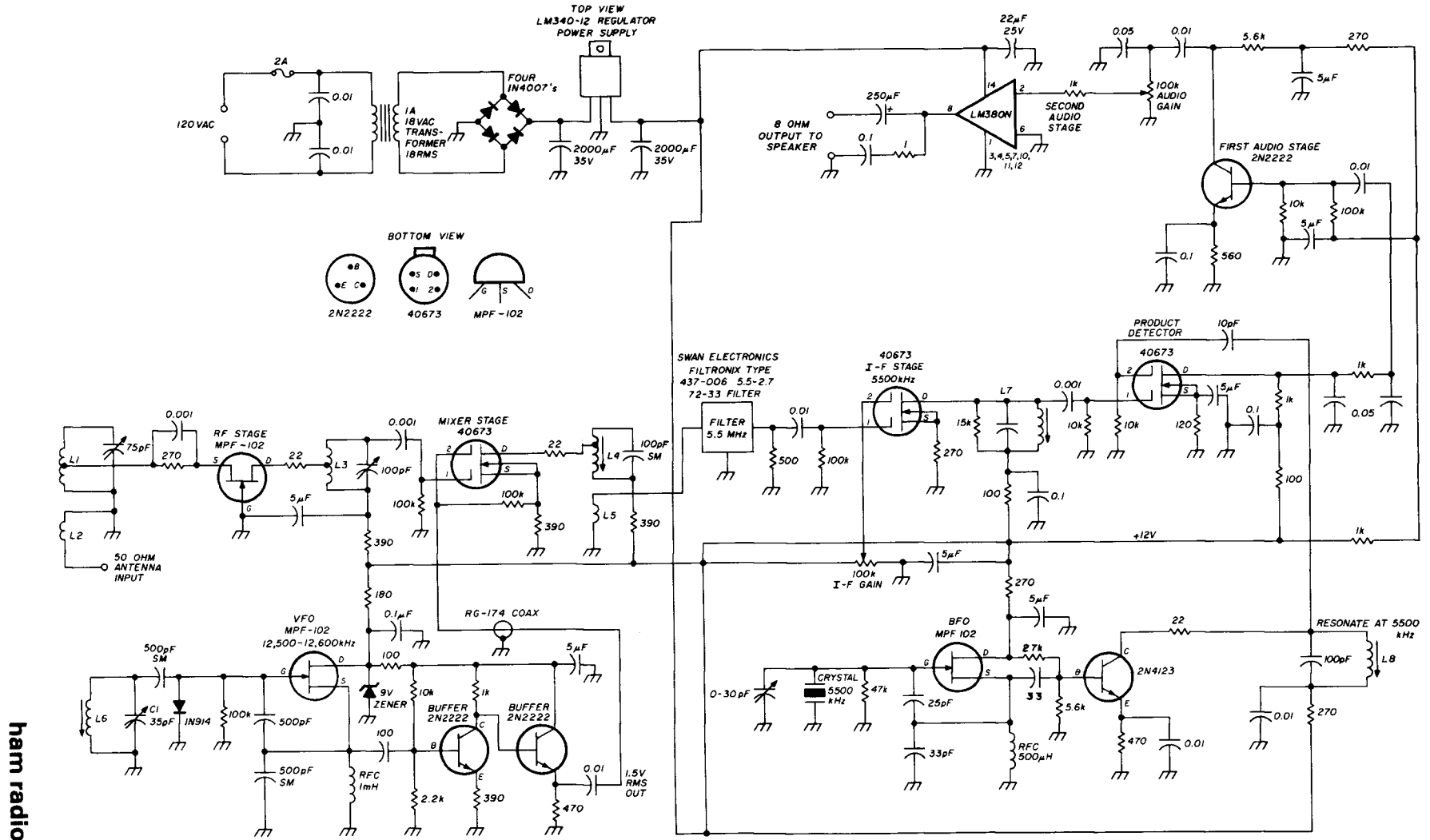

fig. 1. Schematic of the solid-state 40-meter receiver. The MPF-102 rf stage helps selectivity, especially when foreign broadcast stations appear at night. PC boards are used, which were made using the tape-and-etching method. Low-frequency circuits could be mounted on perf boards. The 5.5-MHz filter was picked up at local flea market.

# comments

(Continued from Page 6)

the product of baud speed times  $K$ ,  $K$  being a factor depending on the "goodness" of a circuit. The baud speed of Amateur Hellschreiber is 122.5 which multiplied by a  $K$  factor of 3 gives a bandwidth of 367.5 Hz. The  $K$  factor of 3 comes into the picture because it has long been recognized that a square wave and its third harmonic is perfectly acceptable for normal communications. The bandwidth of a 45.5-baud, 170-Hz shift RTTY computed according to CCIR is 245 Hz.

K6KA is correct in his criticism of the Chinese Hell-Fax signal, lately on 14140 and believed still to be working in the Region 2, 80-meter band. But this is a different system with a baud speed of somewhere in the region of 400, and observedly with little or no attempt at pulse shaping; some channels are even FSK with 800 Hz shift! They are certainly wide band and not to be compared with the Amateur 'hell' in Europe.

Finally, I hold no brief for the Hellschreiber system as such but, as I worked with the system throughout most of its active life and am fully conversant with its advantages and shortcomings, I thought I'd like to put the matter straight.

**Stanley A.G. Cook, G5XB**  
**Radio Society of Great Britain**  
**Reading RG4 9BP, England**

## PCB "threat"

Dear HR:

I noted in "Presstop" in May, 1980, issue your warning regarding the "potentially deadly threat" existing in the form of PCBs or polychlorinated biphenyls, and should like to thank you for bringing the attention of the fraternity to this material.

However, I should like to point out that the PCB hazard has been, like many others, vastly overrated by media exposure. PCB in massive doses fed to lab test animals has been

shown to produce malignant tumors, and repeated applications to the skin of mice has indicated some potential as a dermal carcinogen.

PCB came to the attention of health authorities through two major instances. One was in Japan, where, by error, it was substituted for fish oil in food packaging. The second instance occurred in the U.S., where, in error, it was added in place of vegetable oil, to cattle feed. In both cases severe illness resulted from the consumption of the PCB-contaminated food.

Occasional handling of PCB has shown no deleterious effects on humans. In fact, many Amateurs who are also Industrial Electricians will testify that they have had their hands in it innumerable times, and in big transformer work have literally been immersed in it, with no visible short- or long-term effects.

The properties of PCB, which make it such an excellent electrical insulating fluid, are the qualities that cause the physical and ecological problems. It is heavier than water, non-conductive, and will not break down or decompose at temperatures under 2000°F. In fact it requires the full 3500°F heat of a cement kiln to break it down. Under normal conditions, it is not bio-degradable. This is its biggest hazard. Once spilled, it remains in the ground indefinitely, being propagated by natural ground waters, absorbed unchanged by plants, which are then eaten by animals.

Incidentally, if you have a tube-type television set or refrigerator more than ten years old, fluorescent lights, or a car with brake fluid or hydraulic fluid more than ten years old, you probably have another source of PCB.

Amateurs, building or buying dummy loads without transformer oil, and having gone to their local utility for a gallon of "good, hi-temperature transformer oil" have received a gallon of PCB. All the above is presented to show that PCBs have been around and done a good job for years, and

pose no "potentially deadly threat" in the quantities hams use.

PCBs can be differentiated from mineral or vegetable transformer oils by the following means:

1. The smell of PCBs is somewhat similar to that of moth balls. Ordinary vegetable or mineral transformer oils smell like oil.
2. Pure PCB is heavier than water, and a drop dropped into a bottle of water will sink. Ordinary transformer oil will float on water.

If you have a PCB-filled dummy load that has a leak or a filter capacitor filled with PCBs that shows a leak around the bushings these leaks can be easily repaired using "Weldfast 220" or equivalent epoxy. First clean off all PCB seepage with a good solvent; "Xylene" will do fine. Wear rubber gloves to protect you from both the Xylene and the PCBs, and store contaminated wipers in a sealable can. Mix the epoxy, smear over and around the leak, and let it set. Job done.

Clean up any spilled PCBs well with Xylene and rags. Store rags, rubber gloves, and all contaminated materials in a sealed can. The whole object of the game is to keep the PCB from getting directly into your food and from getting into the food chain via the earth and ground water. A call to your public utility will provide a safe method of disposing of your PCB wastes.

Above all, remember PCBs are a hazardous substance, not a "deadly threat." Inspect your capacitors and ensure they are not leaking PCBs. If they are, repair the leaks and clean up the spills properly, or remove the bad component and clean up the spill properly. Put all contaminated materials in a sealed can, wash your hands well, call your public utility and make the necessary disposal arrangements. Don't panic and throw them in the garbage. If you do, you can be sure of getting your share of them back through the food chain.

**Tom Ruynon, VE5UK**  
**Saskatoon, Saskatchewan**

## speed of light

Dear HR:

In his amusing exposé, W7ITB has drawn before our eyes the frightening picture of all our emissions eventually coming back upon us because of the speed of light becoming negative by the 2100th century.

May I draw your attention to a hint at a much earlier date of this reversal? In the May, 1976, issue of *ham radio* on page 31 VK2ZTB cites the speed of light to be  $290500 \text{ km s}^{-1}$ . Should we all possibly have overlooked this dramatic 3 per cent decrease or could it be a specific development of our fellow Australian hams working towards a "light boomerang?"

Gunter Hoch, KL6WU  
Darmstadt-Eberstadt

## surplus tubes

Dear HR:

I agree with Bill Orr's suggestion in December *ham radio* that one should test surplus tubes as soon as possible after their receipt. However, I object to his blanket condemnation of mail-order surplus houses, that customers have a "fat chance" of getting a refund or replacement for a defective surplus tube purchased via mail order.

We at Fair Radio Sales have been selling used and unused surplus tubes to Radio Amateurs for many years. As a matter of policy, we replace an unsatisfactory tube or refund its price, provided the customer's claim is made within ten days or so of the tube's receipt.

Like any reputable business, we feel that we have the responsibility to make every reasonable effort to satisfy our customers. Undoubtedly there are other surplus dealers who share this commitment to their customers.

Orr's remark was a disservice to the conscientious surplus mail order companies — many of which advertise in *ham radio*.

George Sellati  
Fair Radio Sales  
Lima, Ohio

## short circuits

### Yagi antenna design: performance calculations

The caption for Table 1 on page 25 of the January, 1980, issue of *ham radio* should read: Element reactance for different wavelength-to-radius ratios, K. The caption for fig. 2 should read: Graph showing the relationship between the wavelength-to-radius ratio, K . . . .

### coaxial-line transformers

W6TC reports that on page 17 of the February, 1980, issue of *ham radio*, eight lines below the heading "50/200 ohm transformers," the text should read: ". . . two pairs of RG-58 A/U [not RG-59 A/U] cable."

### Touch-Tone decoder

The schematic of the *Touch-Tone* decoder that appeared in the February, 1980, issue of *ham radio* (page 37) should show a crystal, not a resistor, at pin 2 of U3. Pins 3 and 5 of U10 are tied to +12 volts, with pin 4 tied to D1 of the sequential control outputs. The price of the complete kit is \$140, assembled and tested \$160, from James Wyma, WA7DPX, 12952 Osborne St., Arleta, California 91331.

### capacitance measurement

Fig. 1 of the *Capacitance Measurement* article that appeared on page 44 of the April, 1980, issue of *ham radio* appeared with the HI and LO positions of S1B inadvertently reversed. The open contact, which should be marked HI, is grounded.

### experimental high-gain phased array

In KL7IEH's high-gain phased array article, which appeared on page 44 of the May, 1980, issue of *ham radio*, the reflector elements in figs. 1 and 5 should be broken in the middle, as should the first director in fig. 1. In fig. 4, elements D<sub>1</sub> and D<sub>2</sub> are reversed.

## G133 HF RECEIVER



0.2 to 30 Mhz SSB, AM, CW in thirty continuously tuneable bands. Set is Collins 51S1 repackaged by LTV-Temco for military with added AM BFO, extra filtering, and jack for 14-600 KHz tuner. 50 ohm input impedance; 600 or 4 ohm audio output. 16 tubes. Requires 115/230 VAC 50-400 Hz, 24 VDC for AM BFO. 6 1/4 x 18 1/4 x 13"; 40 lbs. sh. More info upon request. Used, repairable: \$695. Checked: \$850. Collins 51S1 manual. \$15 when purchased with G133. Prices F.O.B. Lima, O. • VISA, MASTERCARD Accepted. Allow for Shipping • Send for New FREE CATALOG! Address Dept. HR • Phone: 419/227-6573

### FAIR RADIO SALES

1016 E. EUREKA • Box 1105 • LIMA, OHIO • 45802

## Isotron Antennas

THE ULTIMATE space savers . . .  
for 80 and 40 meters.

Designed  
and  
proved  
by  
W0BEJA



Hear on  
7245 kHz  
at  
3 & 5 PM  
MDT

80 Meters

4 1/2 ft.  
8 lbs.  
110 kHz\*  
500 coax  
\$54.95

or

Length  
Weight  
Bandwidth  
Feed  
Price

40 Meters

31 in.  
4 lbs.  
250 kHz\*  
500 coax  
\$44.95

\*Limits for 2:1 SWR; center frequency adjustable

Isotron antennas need no radials or matching devices. Feed with 500 coax. For indoor or outdoor mounting. Excellent for all amateur uses.



BILAL COMPANY

(303) 687-3219



STAR ROUTE

FLORISSANT, CO. 80816

## HAM SCAN II

The only full-band scanner with one channel of memory for the following rigs: KENWOOD 7625, 7600, 7400A; KDK 2015R, 2016A; CLEGG FM-28; MIDLAND 13-510; HEATHKIT HW-2036; Others coming soon.

- Adds one channel of memory to any above rig
  - Selectable scan range — up to 4 MHz (— by position of radio's MHz switch)
  - Scan rate 200 kHz/sec. in 10 kHz steps (— 3-second pause on all active channels)
  - Mike-mounted switch provides 3 functions: start/stop, remote frequency incrementing, and transmit interlock while actively scanning.
  - Scanner mounts inside radio — no external box
  - Assembled, tested, & guaranteed — \$59.95 plus shipping
- Ask about our TM-1 timer module, our TC-2 sub-audible tone encoder, and our Ham Scan I for the Yaesu FT227R

## Technical Clinic

P.O. BOX 636

STERLING HTS. MI 48078

Phone Orders Call: (313) 286-4836

### 35w 2m FM AMPLIFIER KIT

3 Watts In—35Watts Out

Great Add-On For  
Hand-Helds

Featured in  
Sept. '79 QST Mag.  
Pages 11-16



\$69.95  
P.P.O.  
USA

MODEL 335-K

COMMUNICATION CONCEPTS INC.

2648 NORTH ARAGON AVE.

DAYTON, OHIO 45420

(513) 296-1411



EFFECTIVE JULY 1, 1980

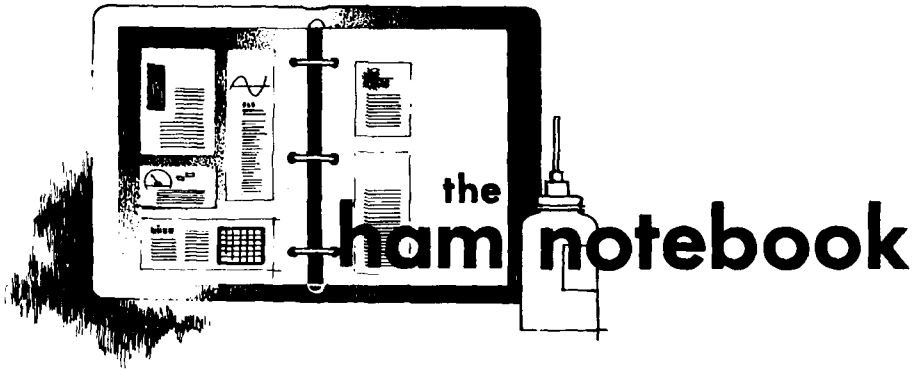

## another improvement for the Ten-Tec Omni-D CW agc

The improved CW agc for the Ten-Tec Omni-D transceiver by Doug McDougall (*ham radio*, January, 1980, page 88) adds a needed feature. However, McDougall's approach using a new switch deck didn't appeal to me because it requires a cooling-off delay and material not in my junk box.

An examination of the circuit sug-

gested that the CW-agc change could be made using diodes instead of a new switch deck. Fig. 1 shows the circuit installed in my radio. The original mute relay circuit seems to be unaffected by the change, and the improved CW agc works as described by McDougall's modification. The 1-k resistor and diodes allow C3 to charge and discharge only in the CW mode.

My thanks to McDougall and *ham radio* for publishing the article, which led to my circuit.

John Bunting, W4NET

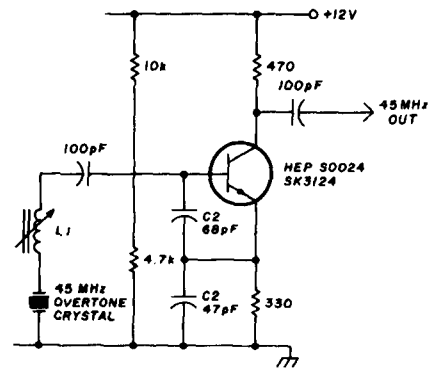
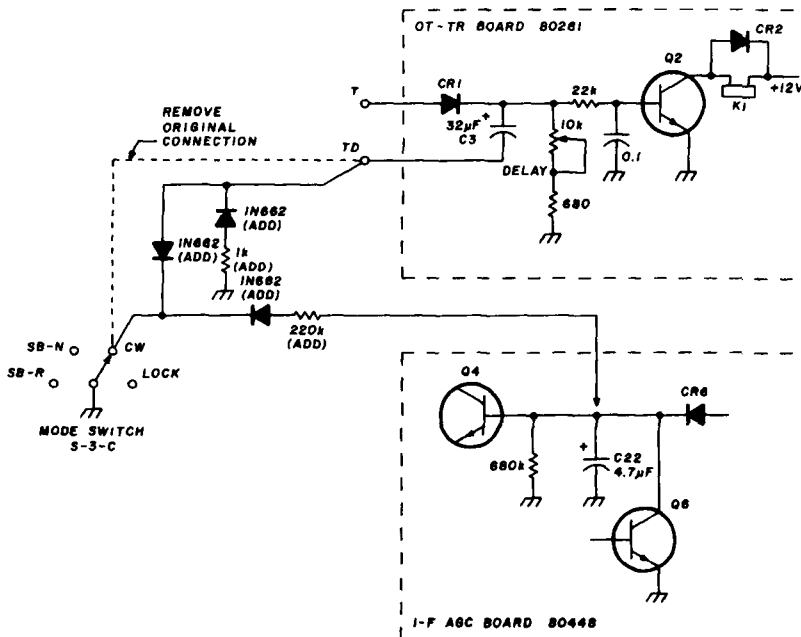

## overtone crystal oscillator

I found WB2EGZ's article, "Quartz Crystals — Gems for Frequency Control," *ham radio*, February, 1979, page 37, very interesting. I had a transmitter on my bench with a crystal fault. The transmitter had been modified so that it would operate on 144 MHz; however, the oscillator wouldn't operate in the overtone mode of the crystal. While the article by WB2EGZ was first-class, this is one type of oscillator he didn't cover, although he had a variation of it in his fig. 4. So it was a case of finding out what was happening in my transmitter.

I found that the critical part in the circuit (fig. 2) was inductance L1 in series with the crystal. With the crystal shorted out L1 will resonate with C1, C2, C3 at or near the crystal overtone frequency when the oscillator is operating as an overtone circuit. When the short circuit across the crystal is removed, the crystal will operate in its overtone mode. If L1 is tuned to a much lower frequency, the crystal will operate in its fundamental mode.

The overtone circuit appears to operate as a crystal-locked Clapp oscillator; with the crystal shorted, it becomes a Clapp oscillator.

B.E.G. Goodger, ZL2RP

## impedance of a random-length antenna

Several parameters must be established to provide input for this calculation. There are the wire size and its height above ground, from which the characteristic impedance of the wire as a length of transmission line parallel to the ground is computed. The height above ground must also be expressed in terms of wavelength to establish the radiation resistance of a typical half-wave dipole. This information is found in many texts from Terman, (*Radio Engineers' Handbook*) to publications such as the ARRL *Antenna Book* or *Handbook*.

A change from one band to another will have a major effect on this last parameter. So as a starting point, to illustrate the method, I decided to consider a No. 12 (2.1-mm) wire, 37.5 feet (11.4 meters) above ground, which yields the convenient characteristic impedance of 600 ohms. The 20-meter band was chosen, where the height of 0.57 wavelength results in a radiation resistance to a half-wave dipole of 68 ohms. This number was divided by two, assigning 34 ohms to each quarter wavelength.

After all these preliminaries we have two numbers: 600 ohms and 34 ohms as the wire characteristic impedance; and we have the radiation resistance of a quarter wavelength (68 ohms). We now shift our attention to the Smith chart (fig. 3). If the length of our wire is zero, its impedance must be infinite. This is plotted on the Smith chart as point 0. The 34-ohms radiation resistance of a quarter wavelength, when normalized to 600 ohms, is 0.05666, which was rounded off to 0.057 and plotted on the real axis of the Smith chart as point 1. Points between zero and a quarter wavelength lie on a spiral connecting these two points, which, for simplicity, was approximated by a semicircle centered on the real axis and passing through those two points lying in the left-hand, or capacitive, side of the chart.

The VSWR of point 1 is the inverse

of 0.05666, or 17.65. From this number, the reflection coefficient,  $\Gamma$ , is computed as 0.893.\*

The wire length is now increased to two quarter wavelengths. The reflection coefficient is now the second power of 0.893 or 0.797, corresponding to a VSWR of 8.85. This is plotted as point 2, and is connected to point 1 by a semicircle, centered on the real axis as before, but this time lying in the right-hand half of the chart because it is inductive.

In a like manner, successive values for  $\Gamma$  are computed, as the length of wire is increased by successive quarter wavelength additions, and connected by semicircles, as before.

Although this method is only an approximation, it does afford considerable insight into the characteristics of a long- or random-length wire antenna. For example, suppose you're considering erecting a full-wave antenna fed a quarter wavelength from one end. The quarter-wave end section will have a radiation resistance of about 34 ohms, while the three-quarter-wave end section will present a

radiation resistance of about 100 ohms. Your chances of balancing your feed system to prevent feedline radiation have just gone out the window! It will still radiate effectively, but the opportunity for complications is enhanced.

Using a chart of this type is simple enough. You might become confused with the markings of wavelength on the circumference of the Smith chart if you're not careful. Suppose, for example that you want to make an educated guess about this wire at a length of, say, 1.2 wavelengths. This point would lie between four and five quarter wavelengths and would be located by a radius from the center of the chart to where the inner scale reads 0.05 wavelength. Unfortunately, our starting point (0) is marked 0.25 wavelength, rather than 0, and you must be aware of the possible foul-up. A straight edge marking out this radius intersects the spiral at about 0.296-j0.296. Multiplying these values by 600 ohms gives 177.6-j177.6 as our estimate of what we would have to match to load such an antenna. All of this may seem merely academic, but it should put us in the ball park when it comes to designing a matching network.

Henry S. Keen, W5TRS

$$\Gamma = \frac{VSWR - 1}{VSWR + 1} \quad (1)$$

$$Z_0 = 138 \log \frac{4h}{d}$$

where  $h$  = height above ground  
 $d$  = diameter of wire

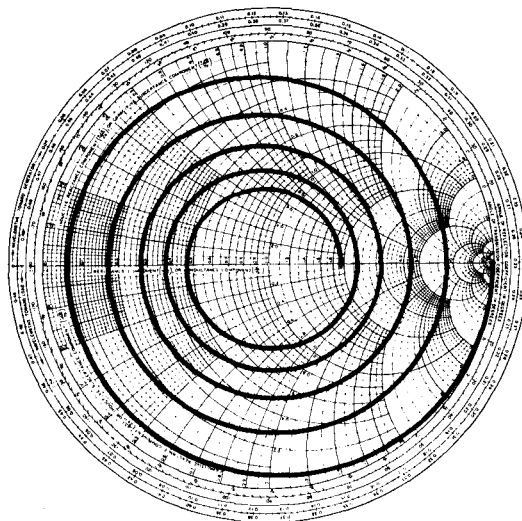

## LARSEN MOBILE ANTENNAS

### Larsen Mount, LM Series

LM-150	2 meter 5/8 wave whip and coil; Reg. \$27.00	\$24.30
LM-MM	Super magnetic mount; Reg. \$16.50	14.16
LM-TLM	Trunk lid mount; Reg. \$15.90	13.59
LM-K	Permanent mount (3/4" hole); Reg. \$7.20	6.15
Q	Quarter wave whip (132-512 MHz)	2.90

### Larsen NLA Mount Series

NLA-150	2 meter 5/8 wave whip and coil; Reg. \$28.90	\$24.74
NLA-MM	Super magnetic mount; Reg. \$17.90	15.30
NLA-TLM	Trunk lid mount; Reg. \$15.90	13.59
NLA-K	Permanent mount (3/4" hole); Reg. \$7.20	6.15
NLA-Q	Quarter wave whip (132-512 MHz); Reg. \$7.60	6.44
NLA-27	Loaded 1/4 wave (27-31 MHz); Reg. \$31.20	26.74

### Larsen Motorola Mount NMO Series

NMO-150	2 meter 5/8 wave whip and coil; Reg. \$28.90	\$24.74
NMO-MM	Super magnetic mount; Reg. \$18.60	15.87
NMO-TLM	Trunk lid mount; Reg. \$19.90	17.01
NMO-K	Permanent mount (3/4" hole); Reg. \$11.00	9.44
NMO-Q	Quarter wave whip (132-512 MHz) Reg. \$7.60	6.44
NMO-27	Loaded 1/4 wave (27-31 MHz); Reg. \$31.20	26.74

### ALSO IN STOCK

Antenna Components • Hustler Mobile Antennas • Palomar Engineers • Centurion International Rubber Duck Antennas

WRITE FOR A FREE COPY OF OUR CATALOG

MASTER CHARGE

VISA

All items F.O.B. Lincoln, \$1.00 minimum shipping. Prices subject to change without notice. Nebraska residents please add 3% tax.

**g & c Communications**  
730 Cottonwood Lincoln, Nebraska 68510

## FAST SCAN ATV

### WHY GET ON FAST SCAN ATV?

- You can send broadcast quality video of home movies, video tapes, computer games, etc. at a cost that is less than slocan.
- Really improves public service communications for parades, RACES, CAP searches, weather watch, etc.
- DX is about the same as 2 meter simplex -- 15 to 100 miles.

### ALL IN ONE BOX



**TC-1 Transmitter/Converter** . . . Plug in camera, ant., mic, and TV and you are on the air. Contains AC supply, T/R sw, 4 Modules below . . . \$399 ppd

### PUT YOUR OWN SYSTEM TOGETHER

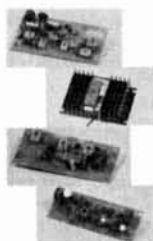

**TXA5 ATV Exciter** contains video modulator and xtal on 434 or 439.25 mHz. All modules wired and tested . . . \$84 ppd

**PA5 10 Watt Linear** matches exciter for good color and sound. This and all modules run on 13.8 vdc. . . . \$79 ppd

**TVC-1B Downconverter** tunes 420 to 450 mHz. Outputs TV ch 2 or 3. Contains low noise MRF901 preamp. . . \$49.50 ppd

**PACKAGE SPECIAL** all four modules \$225 ppd

**FMA5 Audio Subcarrier** adds standard TV sound to the picture . . . \$25 ppd

### SEND FOR OUR CATALOG, WE HAVE IT ALL

Modules for the builder, complete units for the operator, antennas, color cameras, repeaters, preamps, linears, video ider and clock, video monitors, computer interface, and more. 19 years in ATV.

Credit card orders call (213) 447-4565. Check, Money Order or Credit Card by mail.



### P.C. ELECTRONICS

Maryann  
WB6YSS

2522 PAXSON  
ARCADIA, CA 91006

Tom  
W6ORG



## Microcraft's New RTTY READER



**Decodes RTTY signals directly from your receiver's loudspeaker. • Ideal for SWLs, novices & seasoned amateurs. • Completely solid state and self-contained. Compact size fits almost anywhere. No CRT or demodulator required. . . . Nothing extra to buy! • Built-in active mark & space filters with tuning LEDs for 170, 425 & 850 Hz FSK. • Copies 60, 67, 75, & 100 WPM Baudot & 100 WPM ASCII. • NOW you can tune in RTTY signals from amateurs, news sources & weather bulletins. The RTTY READER converts RTTY**

signals into alphanumeric symbols on an eight-character moving LED readout. Write for details or order factory direct.

RTTY READER KIT, model RRK . . . . . \$189.95

RTTY READER wired and tested, model RRF . . . . . \$269.95

Send check or money order. Use your VISA or MasterCard. Add \$5.00 shipping and handling for continental U.S. Wisconsin residents add 4% Wisconsin State Sales Tax.

**Microcraft**

Corporation Telephone: (414) 241-8144  
Post Office Box 513HR, Thiensville, Wisconsin 53092

## COAXIAL CABLE

SEND FOR FREE CATALOG

MIL SPECS — POLYETHYLENE

32¢/ft. RG213 noncontaminating	32¢/ft.
25¢/ft. RG8U 95% shield	25¢/ft.
25¢/ft. RG11A/U 75 ohms	25¢/ft.
10¢/ft. RG62A/U 93 ohms	10¢/ft.

LOW LOSS FOAM

18¢/ft. RG8U 80% shield	18¢/ft.
20¢/ft. RG11U	20¢/ft.
8¢/ft. RG58U	8¢/ft.
8¢/ft. RG59U 100% foil shield	8¢/ft.

ROTOR CABLE

17¢/ft. 2-18ga 6-22ga	17¢/ft.
— shipping \$3 first 100 ft., \$1 ea. add'l. 100 ft.	

CONNECTORS

PL-259 10/\$5.49	S0-239 10/\$5.49 ea.
PL-258 (barrel) 89c ea.	Elbow \$1.59 ea.
UG-175 or 176	UHF T (M358) \$2.39
Reducer 10/\$1.59	— shipping 30c/pkg.

**NEMAL ELECTRONICS**



Dept. RH  
5685 S.W. 80th ST  
MIAMI, FL 33143  
TEL: (305) 661-5534

NO COIL HEATING — RESETTABLE TO EXACT FREQUENCY

### ANTECK, Inc.

BOX 415, ROUTE 1  
HANSEN, IDAHO 83334  
PHONE (208) 423-4100

### MOBILE OPERATORS

LOOKING FOR VALUE, HIGH PERFORMANCE, AND EASE OF OPERATION?

The **MT-1 MOBILE ANTENNA, GENERAL COVERAGE**, 3.2 to 30 MHz. 750 Watts C.W., 1500 P.E.P., CENTER LOADED, Tune to EXACT RESONANCE. NO COIL HEATING. 50 OHMS INPUT. FULL OUTPUT from SOLID STATE FINALS. BASE TUNED WITH LOGGING SCALE AND CORRELATION CHART for ease of resetting. Max. length 116 inches at 3.2 MHz, 92.5 inches at 30 MHz. FITS ANY STD. MOUNT (3/8 X 24 THREAD.) Send for free brochure. MAX. DIA. OF COIL 1.125 INCH.

Check with your LOCAL DEALER OR ORDER DIRECT **\$129.95 PLUS UPS**  
**MT-1A HEAVY DUTY STAINLESS STEEL MARINE UNIT \$179.95 PLUS UPS**

NO COILS TO CHANGE — POSITIVE TUNING LOCK — LESS THAN 1.5 VSWR



STAINLESS STEEL WHIP — FIBERGLASS LOADING COIL

BASE TUNED WITH LOG — NO TUNERS REQUIRED

**1981  
1981  
CALLBOOKS  
HANDBOOK  
1981  
COMING  
SOON!**



# Now a Complete Line of Antenna Accessories

From Barker & Williamson, Inc.

## Model CC-50

Rugged cast aluminum weatherproof dipole center connector.



## Model 370-1

Antenna traps for 5 Band antenna (80 thru 10 meters) with complete instructions for antenna assembly.



## Model 370-2

Antenna traps for 4 Band antenna (40 thru 10 meters) with complete instructions for antenna assembly.



## Model 370-5

Heavy duty antenna insulator. Over 1000 lb. pull strength.



## Model 370-7

140 ft. #14 Copperweld antenna wire.



## Model 370-8

50 ft. RG-8 Type coax cable.



## BC-1

Professional quality BROADBAND BALUN. 50 ohms balanced to 50-75 ohms unbalanced. 2.5 KW-5KW PEP.



## BC-2

Professional quality BROADBAND BALUN. 50-70 ohms unbalanced to 200-300 ohms balanced. 2.5 KW-5 KW PEP.



Available at your B & W Dealer or Write: Barker & Williamson, Inc. 10 Canal Street, Bristol, Pa. 19007

## DEALERS WANTED

### TOWERS

by ALUMA  
HIGHEST QUALITY  
ALUMINUM  
& STEEL

60 Ft. Aluminum.  
Crank-Up  
Model T-60-H

40' Steel  
Crank-Up  
Model SHD-40

- ★ TELESCOPING (CRANK UP)
  - ★ GUYED (STACK-UP)
  - ★ TILT-OVER MODELS
- Easy to install. Low Prices.  
Crank-ups to 100 ft.

EXCELLENT FOR  
HAM COMMUNICATIONS

SPECIAL  
Four Section 50 Ft.  
Van Mounted Crank-Up  
Aluma Tower

Over 36 types aluminum  
and steel towers made—  
specials designed and  
made—write for details



**ALUMA TOWER CO.**  
Box 2806HR  
VERO BEACH, FLA. 32960  
PHONE (305) 567-3423  
TELEX 80-3405

## STEP UP TO TELREX

Professionally Engineered Antenna Systems

Single transmission line "TRI-BAND® ARRAY"

MONARCH  
TB5EM/4KWP

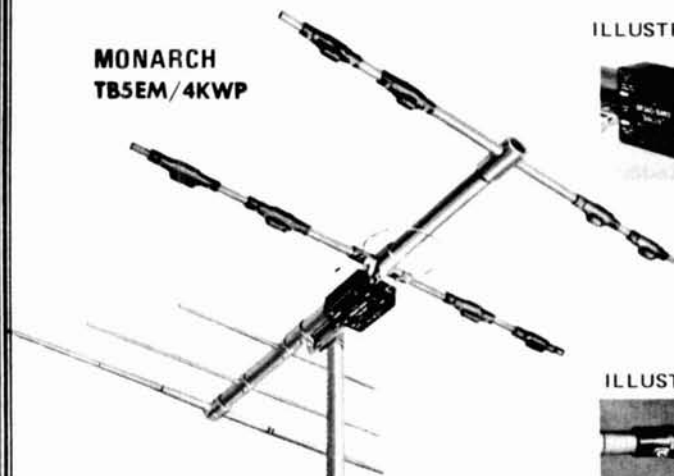

ILLUSTRATION BALUN



ILLUSTRATION TRAP



By the only test that means anything . . . on the air comparison . . . this array continues to outperform all competition . . . and has for two decades. Here's why . . . Telrex uses a unique trap design employing 20 HiQ 7500V ceramic condensers per antenna. Telrex uses 3 optimum-spaced, optimum-tuned reflectors to provide maximum gain and true F/B Tri-band performance.

For technical data and prices on complete Telrex line, write for Catalog PL 7

COMMUNICATION SYSTEMS SINCE 1921 **telrex** Laboratories  
ASBURY PARK, NEW JERSEY 07712, U.S.A.

# Heath/Zenith Instruments:



Heath/Zenith instruments are professional units that give you good value for your money. A wide selection to let you choose the unit with the features you need — without paying for a lot of bells and whistles you don't. Manufactured to strict Heath/Zenith standards. Inspected at every step of assembly to assure performance to specifications. They're built to last; built to give

you reliable service. 61 U.S. and Canadian locations offer service, should it ever be necessary. Whether you need a test instrument for electronics service work, manufacturing and design, or serious hobby applications, Heath/Zenith instruments are a good choice. The selection offered here is just part of our total instrument line. Order TOLL FREE 800-253-0570.

**NEW**

## New 10 Hz-225 MHz Frequency Counter



**\$159<sup>95</sup>**

- 10 mV typical sensitivity
- Single input gives entire range
- Crystal-controlled time base
- 0.1, 1.0 second dual time gates
- Full voltage protection
- Easy-to-read 8-Digit display
- 3.38" H x 7.25" W x 9.0" D

SM-2410 ..... 159.95  
(\$2.30 shipping & handling)  
SMA-2400-1, Antenna ..... 9.95  
(\$1.60 shipping & handling)

**NEW**

## New 5 Hz-512 MHz Frequency Counter



**\$299<sup>95</sup>**

- Ideal for 2-way UHF work
- Ovenized, high-stability, crystal timebase
- 8-Digit resolution
- 10 mV typical sensitivity
- .01, .1, 1, 10 second gate times to fit your needs
- Trigger level control
- Frequency ratio function
- Period function
- 4.25" H x 10.0" W x 13.0" D

SM-2420 ..... 299.95  
(\$2.75 shipping & handling)  
SMA-2400-1, Antenna ..... 9.95  
(\$1.60 shipping & handling)

**NEW**

## New Hand-held 512 MHz Counter



**\$179<sup>95</sup>**

- Easy-to-read 7-digit display
- 10 mV typical sensitivity
- Includes nickel-cadmium batteries
- AC or battery operation
- .1 second and 1 second time gates with automatic decimal point placement
- Leading zero blanking
- Crystal-controlled time base
- Full voltage protection
- 2.0" H x 3.38" W x 8.25" D

SM-2400 ..... 179.95  
(\$1.90 shipping & handling)  
PS-2404 120V Battery Eliminator/  
Charger (required) ..... 4.95  
(\$1.60 shipping & handling)  
PS-2405 240V Battery Eliminator/  
Charger (required) ..... 12.95  
(\$1.60 shipping & handling)  
SMA-2400-1 Telescopic  
Antenna ..... 9.95  
(\$1.60 shipping & handling)

## Hand-held Multimeter gives 0.1% accuracy

**\$129<sup>95</sup>**

- Measure voltage, current, resistance
- Easy-to-read Liquid Crystal Display
- Five DC voltage ranges — 200mV-1000V
- Five AC voltage ranges — 200mV-750Vrms
- Four DC current ranges — 2mA-2000mA
- Four AC current ranges — 2mA-2000mA
- Six resistance ranges — 200Ω-20MΩ
- Uses one 9V battery or 120/240 VAC
- 2.0" H x 3.5" W x 7.5" D

SM-2215 ..... 129.95  
(\$1.75 shipping & handling)  
IMA-2215-1 Leather Carrying Case .. 14.95  
(\$1.60 shipping & handling)  
PS-2350 120VAC Battery Eliminator .. 4.95  
(\$1.60 shipping & handling)  
PS-2450 240VAC Battery Eliminator .. 14.95  
(\$1.60 shipping & handling)



# professional quality, excellent value

## General-purpose Power Supply



\$210<sup>00</sup>

- Supplies B+, C- and filament voltages
- 0-400 VDC output at 0-100 mA continuous (125 mA intermittent)
- Output variation less than 1% from no load to full load for 100-400VDC
- Ripple less than 10 mVrms
- Output impedance 10 Ω from DC-1 MHz
- C- Voltage 0 to -100 VDC at 1mA
- Filament voltage 6.3 VAC at 4 amp.
- 5.5" H x 13.38" W x 11.25" D

SP-2717 ..... 210.00  
(\$4.40 shipping & handling)

## Tri-Power Supply



\$185<sup>00</sup>

- Fixed 5 VDC at 1.5A and two continuously-adjustable 0-20 VDC at 500mA
- Interconnect outputs in any combination
- Clutch-coupled 20 VDC supplies for dual-tracking operation
- All outputs short-circuit proof
- Ripple and noise less than 5 mVrms
- Load or live regulation provides less than 0.1% (20 mV) variation on 20V supplies and less than 2% variation on 5V supply
- 4.5" H x 10.75" W x 9.0" D

SP-2718 ..... 185.00  
(\$3.15 shipping & handling)

## Sine-square wave Audio Generator

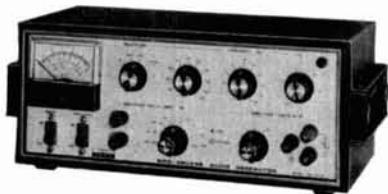

\$185<sup>00</sup>

- 1 Hz-100 kHz frequency range
- 0.003-10 Vrms sine wave output (10k Ω load)
- 0.003-1 V sine wave output (600 Ω load)
- Meter calibrated in volts and dB
- -62 to +22 dB ranges
- 0.1-10 V square wave output (2000 Ω load)
- 50 nanosecond risetime
- 5.13" H x 13.25" W x 7.0" D

SG-5218 ..... 185.00  
(\$2.85 shipping & handling)

## Dual-trace DC-10 MHz Oscilloscope

\$650<sup>00</sup>

- Two vertical input channels with 10 mV/cm sensitivity
- 11-step attenuator for 10mV/cm to 20V/cm deflection factors
- 19-step horizontal time base from 0.2 sec/cm to 0.2 usec/cm
- Vertical accuracy within 3%
- X5 horizontal expansion
- Calibrated 1V peak-to-peak square wave signal
- 35 ns vertical rise time
- Automatic triggering
- 120/240 VAC, switch-selectable
- 6.9" H x 12.9" W x 19.3" D

SO-4550 ..... 650.00  
(\$5.50 shipping & handling)



## Combination x1, x10 Scope Probe

\$29<sup>95</sup>

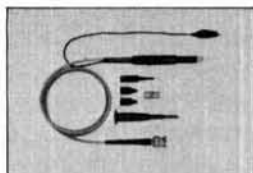

- Switch-selectable x1 and x10 attenuation at probe tip
- Center (ground) switch position allows quick zero level check
- DC to 15 MHz (x1) and DC to 80 MHz (x10) bandwidths
- 4.0 nS (x10) rise time
- Insulating tip, BNC tip adapter, IC tip, insulated compensation capacitor adjustment tool, vinyl case

PKW-105 ..... 29.95  
(\$1.60 shipping & handling)

**Order TOLL-FREE:**  
**800-253-0570**

8:00 AM to 8:00 PM Eastern Time M-F. Sorry, toll-free service not available in Alaska, Hawaii or Michigan. Call 616-982-3411, 24 hours a day, seven days a week. TLX: 72-9421

**HEATH**  
**ZENITH**

**Instruments**

For information on other Heath/Zenith Instruments write:  
Dept. 122-698, Benton Harbor, MI 49022  
GX-383

To receive your order faster, charge it!  
Use your Visa, MasterCard or Heath Revolving Charge.  
Please have your card or account number handy when you call.



61 Service locations throughout the United States and Canada

Heathkit Electronic Centers in the U.S.\* and Canada are listed in phone directory white pages.

\*Units of Veritechnology Electronics Corporation.





# NEW products

## RTTY Reader

A new radioteletype code reader has been introduced by Microcraft Corporation for SWLs, Novices, and veteran radio operators. It is completely self-contained, featuring an eight-character moving LED display, separate, active, mark and space filters, and tuning LEDs. All text characters — letters, numbers, and punctuation, are shown sequentially on the display. It features an extremely versatile decoding system capable of handling 170, 425, and 850 Hz FSK with RTTY speeds of 60, 67, 75, and 100 WPM Baudot and 100 WPM ASCII. All that is required for operation is to connect it to the loudspeak-

er of a communications receiver — no CRT is needed. It is compact, measuring 7.375 x 5.75 x 3.375 inches (18.73 x 14.6 x 8.57 cm), and weighs 4 pounds (1.8 kg). The kit version, RRR, recommended only for intermediate to advanced builders, costs \$189.95. The wired and tested version, RRF, is \$269.95. An optional 220 Vac, 50/60 Hz transformer is available for an additional \$6.00. Shipping and handling in the Continental United States is an additional \$5.00. Shipments are made worldwide and requests for quotes are invited. Contact Microcraft Corporation, P.O. Box 513, Thiensville, Wisconsin 53092.



## Spectrum Communications vhf transceivers

Spectrum Communications Corporation has introduced its Professional Communications Line of base-station and mobile transceivers.



The PCL250 mobile unit and the PCL300 base station are 30-watt (nominal) transceivers covering the 136-174 MHz range. Features include: excellent receiver sensitivity (0.3  $\mu$ V), very wide receiver dynamic range for superior intermodulation rejection, eight-pole crystal filters and four-pole ceramic filters, "super-rugged" housing (1/8" aircraft aluminum), six channels, and high quality design, components, and workmanship throughout.



The PCL300 base station has a built-in ac power supply with optional auto-switchover to dc battery power, front-panel status indicator lights, optional receiver scanning function, pre-amp desk or hand-held microphone, and wood grain housing.

For further information, write Spectrum Communications Corp., 1055 W. Germantown Pike, Norristown, Pennsylvania 19401.

## heavy-duty line filters

New heavy-duty, ac power-line filters that handle up to 15 amperes have been introduced by the J.W. Miller Division of Bell Industries in Compton, California.

Sensitive equipment can be protected from interference by these filters. They are ideal for preventing power-line interference from virtually all sources such as copying machines, small computers, and appliances.

Model C-515-L1 (110-120 Vac) and Model C-516-L2 (220-240 Vac) five-section LC-network filters provide 50 dB attenuation or better for 500 kHz to 300 MHz.

In use, the equipment causing the interference is plugged into the filter, and the filter is plugged into an ac outlet. Also, the filter can be plugged in between equipment to be protected and the ac power.

Additional information may be obtained from Jerry Hall, J.W. Miller Division, Bell Industries, 19070 Reyes Avenue, Compton, California 90221.

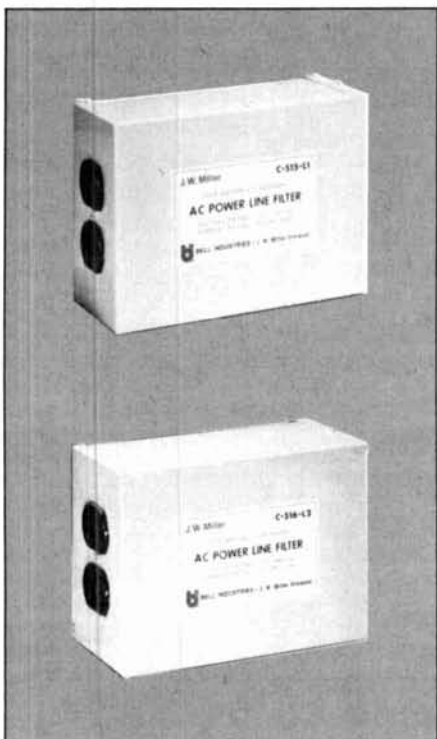

# Antenna Tuner



## New low profile design.

Here is the famous Palomar Engineers high power tuner in a new compact size. Only 5½" x 14" x 14" yet it has all the features, works from 160 through 10 meters, and works with coax, single wire and balanced lines. And it lets you tune up without going on the air!

### WE INVESTIGATED

All tuners lose some rf power. We checked several popular tuners to see where the losses are. Mostly they are in the inductance coil and the balun core.

So we switched from #12 wire for the main inductor to ¼" copper tubing. It can carry ten times the rf current. And we've moved the balun from the output, where it almost never sees its design impedance, to the input where it always does. Thus more power to your antenna.

### IMPOSSIBLE FEAT

The biggest problem with tuners is getting them tuned up. With three knobs to tune on your transceiver and three on the tuner and ten seconds to do it (see the warning in your transceiver manual) that's 1½ seconds per knob.

We have a better way; a built-in 50-ohm noise bridge that lets you set the tuner controls without transmitting. And a switch that lets you tune your transmitter into a dummy load. So you can do the whole tuneup without going on the air. Saves that final; cuts QRM.

### BROCHURE AVAILABLE NOW

For further details on this exciting new high-power low-loss, easy-to-use tuner send for our new brochure. Or visit your Palomar Engineers dealer.

**Model PT-3000, \$349.50. To order send \$10.00 shipping/handling. California residents add sales tax.**



# Palomar Engineers

Box 455, Escondido, CA. 92025 • Phone: [714] 747-3343

# Handful of POWER

Ask about our 50 and 100 watt amplifiers for use with low-power hand-held radios!



Give your low-power 2-meter rig real punch by delivering a potent 25-watt signal with only two watts of drive (also available set up for 200 milli-watts drive). Compact and convenient to mount VoCom's Model 2C025 is ideal for car, boat, or anywhere you've got a 12 VDC source. At only \$84.95 (\$99.95 for 200 mW drive), it's the perfect companion for your Drake, Encomm, Henry, Icom, Kenwood, Motorola, Standard, Wilson, Yaesu or other 2-meter FM portable!

- 2 or 2 watt nominal drive (specify)
- 2 watt model delivers 15-20 watts with only one watt of drive
- 10 MHz bandwidth for CAP or MARS
- Meets all applicable FCC specifications
- 200 mW drive model permits operating Icom IC-2A or Yaesu FT-207R on their battery-saving low-power mode
- Only \$84.95 (\$99.95 for 200 mW drive)

Available now from your local amateur radio dealer or order direct:

**VoCom** Box 219, Prospect Heights, IL 60070  
**PRODUCTS CORPORATION** (312) 459-3680

# 1981

**A  
R  
R  
L  
H  
A  
N  
D  
B  
O  
O  
K**

**S  
O  
O  
N**

## KLM circularly polarized antenna

KLM's new 420-450-18C antenna will bring all the advantages of circular polarity to the uhf bands. Flutter and multipath fading can now be reduced for optimized satellite and terrestrial communications. For efficient use of the new Phase III-B OSCAR satellite, the 18C will be a virtual necessity. Its broadband character, in the KLM tradition, also permits the 18C to meet the critical needs of DXers, ATVers, and the 440-450 FM group. According to KLM, gain is conservatively rated at 12 dB.

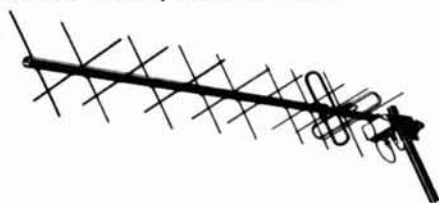

New design and construction techniques have been used to meet the strict electrical requirements for good circularity at uhf. The reflector and director elements of the 420-450-18C pass through the center of the boom and are secured with integral polyethylene insulators and locking snap-rings. Folded dipoles are used for the driven elements. They provide excellent bandwidth and maintain perfect element symmetry. Circularity is held within 1 dB, 430-440 MHz, and 3 dB, 420-450 MHz.

Electrically, the 18C has nine elements in the vertical plane and nine, offset by 1/4 wave, in the horizontal plane. Feed impedance of each section is 50 ohms balanced. Two coaxial baluns are supplied.

The optional CS-2 Circularity Switcher, mounted on the antenna, features fingertip control of circularity (RHC-LHC) in the shack and a built-in power divider, for single-feedline convenience.

Price of the 420-450-18C is \$59.95; the CS-2 is \$49.95. For more information on the 18C and other Phase III related products, contact KLM Electronics, P.O. Box 816, Morgan Hill, California 95037.

### DIPOLE ANTENNA CONNECTOR



**HYE-QUE (HQ-1)** dipole connector has coax SO-239 socket molded into glass filled plastic body to accept coax PL-259 plug on feedline. Drip-cap keeps coax fittings dry. Instructions included. Guaranteed. At your dealers or \$5.95 postpaid. Companion insulators \$1.25/pr.

**BUDWIG MFG. Co.** PO Box 829, Ramona, CA 92065  
 Ca. Res. add 6% Sales Tax

### I PAY CASH

for your military surplus electronics

If you have or know of availability:

TT-98 TT-76 Teletypewriter  
 phone me collect

Dave — (213) 760-1000

## TROUBLE FREE TOUCH TONE® ENCODER

POSITIVE TOUCH (KEYS DEPRESS) • MOBILE • HANDHELD • POSITIVE MOUNT • NO RFI • NO POTTED PARTS (SERVICEABLE) • MIL-SPEC COMPONENTS • SELF CONTAINED • XTAL CONTROLLED • LEVEL ADJUSTMENT FROM FRONT • 4.5 - 60 V.D.C. • WILL OPERATE ANY SYSTEM • LETTERING OPTIONAL

Supplied with: Instructions, schematic, template, hardware. PP-1A designed for Standard Communications Handhelds. (California orders add 6% sales tax.)

**NEW PRICES**

PP-1 = \$49.00 PP-2 = \$53.00 PP1-A = \$58.00  
 PP-1K = \$55.00 PP-2K = \$59.00  
 K-series = Self Contained Delay Relay  
 M-Series - Detached Frame for irregular installations

Available at: Ham Radio Center ..... (800) 325-3636  
 Henry Radio, Los Angeles ..... (213) 272-0861  
 Electronic Equipment, Virginia ..... (703) 938-3350  
 CW Electronics, Denver ..... (303) 893-5525  
 C & A Electronics, Long Beach ..... (213) 834-5868

Send For Complete Dealers List & Catalog

PATENTED

® AT&T

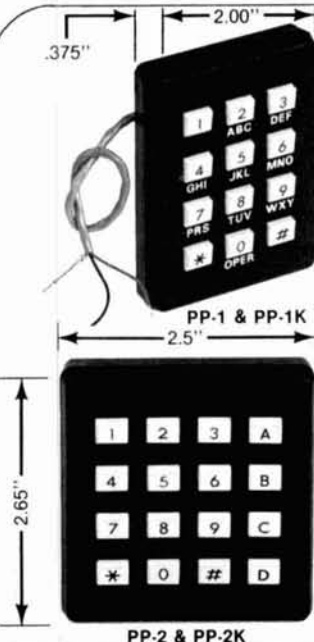

Mail Order To **Pipo Communications**  
 Emphasis is on Quality & Reliability

P.O. Box 3435  
 Hollywood, California 90028  
 213/852 1515

## microprocessor controlled repeater

A line of repeaters covering the 144, 220, and 450 MHz bands has just been introduced by Micro Control Specialties. The new Mark 3CR repeaters combine all the features of the popular Mark 3C repeater controller plus transmitter, receiver, and power supply in a rack-mount cabinet, ready for immediate service. The microprocessor-based repeater provides 39 tone-accessible functions, including autopatch, autodial, redial, reverse patch, external outputs, and secure control-operator commands. Crystal-controlled digital tone-decoding assures stable and reliable function access. To keep users informed of its status, the repeater generates thirteen different Morse messages, several of which are custom programmed to user specifications. Basic repeater operations such as timeout, tail, and ID timing are also directed by the microprocessor so the repeater can discriminate intelligently against noise and "kerchunkers." Several operations can be modified remotely by command functions.

The repeater receiver uses dual-gate MOSFETS in both rf amplifier and mixer stages for high sensitivity (20 dB quieting with only 0.25  $\mu$ V of input signal) and freedom from overload in the presence of 0.5-volt signals. Crystal filtering and double conversion are both used to obtain 65 dB rejection of off-frequency signals.

Transmitter output is 2 watts, but optional amplifiers are available to increase the power output to any desired level. Transmitter and receiver oscillators are temperature compensated to meet commercial frequency-stability requirements. The audio circuits combine generous amounts of feedback with symmetrical clipping for virtually transparent audio quality.

For further information, write Micro Control Specialties, 23 Elm Park, Groveland, Massachusetts 08134.

## ICM TV-4200

# SATELLITE GROUND RECEIVER



International incorporates advanced technology at its best in a fully packaged and assembled receiver covering all satellite channels 3.7-4.2 GHz band. Standard dual audio outputs provided at 6.2 and 6.8 MHz. Other available.

### FULLY TUNABLE

Covers all satellite channels 3.7-4.2 GHz band.

### DUAL AUDIO OUTPUTS

6.2 and 6.8 MHz audio standard. Others available.

### EASY TO USE

Simple tuning  
Built-in LNA power supply  
Output levels compatible with video monitor or VTR input.

### OPTIONS (Availability to be announced)

AFC  
Remote tuning  
Additional audio frequencies

### DIMENSIONS

4 $\frac{1}{2}$ "H x 14 $\frac{1}{8}$ "W x 12D



The ICM TV-4200 Satellite Receiver is completely assembled and includes power supply, tuner control circuitry and power cable. Available now. Shipping Weight 12 lbs.

PRICE \$1,995 1-9 QUANTITY



INTERNATIONAL CRYSTAL MANUFACTURING CO., INC.  
10 N. Lee, Oklahoma City, Oklahoma 73102, 405-236-3741

# MHz electronics

## 1900 MHz to 2500 MHz DOWN CONVERTER

This receiver is tunable over a range of 1900 to 2500 mc and is intended for amateur radio use. The local oscillator is voltage controlled (i.e.) making the i-f range approximately 54 to 88 mc (Channels 2 to 7).

PC BOARD WITH CHIP CAPACITORS 13 .....	\$44.99
PC BOARD WITH ALL PARTS FOR ASSEMBLY .....	\$79.99
PC BOARD ASSEMBLED AND TESTED .....	\$120.00
POWER SUPPLY KIT .....	\$44.99
POWER SUPPLY ASSEMBLED AND TESTED .....	\$59.99
YAGI ANTENNA 4' LONG APPROX. 20 TO 23 dB GAIN .....	\$59.99
YAGI ANTENNA 4' WITH TYPE (N, BNC, SMA Connector) .....	\$64.99
<b>2300 MHz DOWN CONVERTER</b>	
Includes converter mounted in antenna, power supply, antenna, 75' and 3' RG59 cable with connectors, 75 to 300 ohm adapter, Plus 90 DAY WARRANTY .....	\$299.99
OPTION #1 MRF902 in front end. (7 dB noise figure) .....	\$349.99
OPTION #2 2N6603 in front end. (5 dB noise figure) .....	\$400.00
<b>2300 MHz DOWN CONVERTER ONLY</b>	
10 dB Noise Figure 23 dB gain in box with N conn. Input F conn. Output .....	\$149.99
7 dB Noise Figure 23 dB gain in box with N conn. Input F conn. Output .....	\$169.99
5 dB Noise Figure 23 dB gain in box with SMA conn. Input F conn. Output .....	\$189.99
DATA IS INCLUDED WITH KITS OR MAY BE PURCHASED SEPARATELY .....	\$15.00

### Shipping and Handling Cost:

Receiver Kits add \$1.50, Power Supply add \$2.00, Antenna add \$5.00, Option 1/2 add \$3.00, For complete system add \$7.50.

### Replacement Parts:

MRF901	\$5.00	.001 chip caps	\$2.00
2N6603	\$12.00	PC Board only	\$25.00 with data
MBD101	\$2.00		

## 3.7 to 4.2 Gc SATELLITE DOWN CONVERTER

70 MHz i-f (40 MHz @ 1 dB)	10 dB min. IMAGE REJECTION	
15 dB max. Noise Figure	25 dB Gain	
ASSEMBLED AND TESTED WITH SMA CONNECTOR FOR INPUT AND F CONNECTOR FOR OUTPUT .....		\$499.99
PC BOARD FOR 3.7 TO 4.2 Gc SATELLITE CONVERTER WITH DATA .....		\$100.00
PC BOARD FOR IF AMPLIFIER WITH DATA .....		\$40.00
PC BOARD FOR DEMOD WITH DATA .....		\$55.00
2 FOOT DISH WITH FEED AND MOUNT .....		\$59.99
PC BOARD WITH ALL PARTS FOR ASSEMBLY PLUS 2N6603 .....		\$89.00
<b>I-F AMPLIFIER FOR ABOVE 70 MHz</b>		
45 dB Gain — 30 MHz @ 3 dB — ASSEMBLED AND TESTED F CONNECTOR .....		\$129.99
<b>DEMOD FOR ABOVE 70 MHz</b>		
COMPOSITE VIDEO OUTPUT (NO RF) — ASSEMBLED AND TESTED .....		\$179.99

### TERMS:

**WE REGRET WE NO LONGER ACCEPT BANK CARDS.**

PLEASE SEND POSTAL MONEY ORDER, CERTIFIED CHECK, CASHIER'S CHECK OR MONEY ORDER.  
PRICES SUBJECT TO CHANGE WITHOUT NOTICE. WE CHARGE 15% FOR RESTOCKING ON ANY ORDER.

ALL CHECKS AND MONEY ORDERS IN US FUNDS ONLY.

ALL ORDERS SENT FIRST CLASS OR UPS.

ALL PARTS PRIME AND GUARANTEED.

WE WILL ACCEPT COD ORDERS FOR \$25.00 OR OVER, ADD \$1.50 FOR COD CHARGE.

PLEASE INCLUDE \$1.50 MINIMUM FOR SHIPPING OR CALL FOR CHARGES.

WE ALSO ARE LOOKING FOR NEW AND USED TUBES,  
TEST EQUIPMENT, COMPONENTS, ETC.

WE ALSO SWAP OR TRADE.

FOR CATALOG SEE JANUARY, 1980, 73 Magazine, 10 Pages.

(602) 242-3037

(602) 242-8916

2111 W. Camelback  
Phoenix, Arizona 85015



# MHz electronics

## FAIRCHILD VHF AND UHF PRESCALER CHIPS

95H90DC	350 MHz Prescaler Divide by 10/11	\$9.50
95H910C	350 MHz Prescaler Divide by 5/6	9.50
11C90DC	650 MHz Prescaler Divide by 10/11	16.50
11C91DC	650 MHz Prescaler Divide by 5/6	16.50
11C83DC	1 GHz Divide by 248/256 Prescaler	29.90
11C70DC	600 MHz Flip/Flop with reset	12.30
11C58DC	ECL VCM	4.53
11C44DC/MC4044	Phase Frequency Detector	3.82
11C24DC/MC4024	Dual TTL VCM	3.82
11C08DC	UHF Prescaler 750 MHz D Type Flip/Flop	12.30
11C05DC	1 GHz Counter Divide by 4	74.35
11C01FC	High Speed Dual 5-4 Input NO/NOR Gate	15.40

## WISPER FANS

This fan is super quiet, efficient cooling where low acoustical disturbance is a must. Size 4.68" x 4.68" x 1.50", Impedance protected, 50/60 Hz. 120 Vac.

\$9.99

## TRW BROADBAND AMPLIFIER MODEL CA615B

Frequency response 40 MHz to 300 MHz  
Gain: 300 MHz 16 dB Min., 17.5 dB Max.  
50 MHz 0 to -1 dB from 300 MHz

Voltage: 24 volts dc at 220 ma max. \$19.99

## CARBIDE — CIRCUIT BOARD DRILL BITS FOR PC BOARDS

Size: 35, 42, 47, 49, 51, 52	\$2.15
Size: 53, 54, 55, 56, 57, 58, 59, 61, 63, 64, 65	1.85
Size: 66	1.90
Size: 1.25 mm, 1.45 mm	2.00
Size: 3.20 mm	3.58

## CRYSTAL FILTERS: TYCO 001-19880 same as 2194F

10.7 MHz Narrow Band Crystal Filter  
3 dB bandwidth 15 kHz min. 20 dB bandwidth 60 kHz min. 40 dB bandwidth 150 kHz min.  
Ultimate 50 dB: Insertion loss 1.0 dB max. Ripple 1.0 dB max. Ct. 0 +/- 5 pf 3600 ohms. \$5.95

## MURATA CERAMIC FILTERS

Models: SFD-455D 455 kHz	\$3.00
SFB-455D 455 kHz	2.00
CFM-455E 455 kHz	7.95
SFE-10.7 10.7 MHz	5.95

## TEST EQUIPMENT — HEWLETT PACKARD — TEKTRONIX — ETC.

<b>Hewlett Packard:</b>		
491C	TWT Amplifier 2 to 4 Gc 1 watt 30 dB gain	\$1150.00
608D	10 to 420 mc. 1 uV to .5 V into 50 ohms Signal Generator	500.00
612A	450 to 1230 mc. 1 uV to .5 V into 50 ohms Signal Generator	750.00
614A	900 to 2100 mc Signal Generator	500.00
616B	1.8 to 4.2 Gc Signal Generator	400.00
618B	3.8 to 7.2 Gc Signal Generator	400.00
620A	7 to 11 Gc Signal Generator	400.00
623B	Microwave Test Set	900.00
624C	Microwave Test Set	950.00
695A	12.4 to 18 Gc Sweep Generator	900.00
1702A	Storage Oscilloscope	1800.00
8691A	1 to 2 Gc Plug In For 8690A Sweeper	800.00
8692A	2 to 4 Gc Plug In For 8690A Sweeper	800.00
8693A	4 to 8 Gc Plug In For 8690A Sweeper	800.00
8742A	Reflection Test Unit 2 to 12.4 Gc	1800.00

<b>Alltech:</b>		
473	225 to 400 mc AM/FM Signal Generator	750.00

<b>Singer:</b>		
MF5/VR-4	Universal Spectrum Analyzer with 1 kHz to 27.5 mc Plug In	1200.00

<b>Keltek:</b>		
XR630-100	TWT Amplifier 8 to 12.4 Gc 100 watts 40 dB gain	9200.00

<b>Polarad:</b>		
2038/2436/1102A	Calibrated Display with an SSB Analysis Module and a 10 to 40 mc Single Tone Synthesizer	1500.00

## HAMLIN SOLID STATE RELAYS

120 Vac at 40 Amps.  
Input Voltage 3 to 32 Vdc.

240 Vac at 40 Amps.  
Input Voltage 3 to 32 Vdc.  
Your Choice \$4.89

## RF TRANSISTORS

TYPE	PRICE	TYPE	PRICE	TYPE	PRICE
2N1561	\$15.00	2N5590	\$8.15	MM1550	\$10.00
2N1562	15.00	2N5591	11.85	MM1552	50.00
2N1692	15.00	2N5637	22.15	MM1553	56.50
2N1693	15.00	2N5641	6.00	MM1601	5.50
2N2832	45.00	2N5642	10.05	MM1602/2N5842	7.50
2N2857JAN	2.52	2N5643	15.82	MM1607	8.65
2N2876	12.35	2N5645	12.38	MM1661	15.00
2N2880	25.00	2N5784	27.00	MM1669	17.50
2N2927	7.00	2N5842	8.78	MM1943	3.00
2N2947	18.35	2N5849	21.29	MM2605	3.00
2N2948	15.50	2N5862	51.91	MM2608	5.00
2N2949	3.90	2N5913	3.25	MM8006	2.23
2N2950	5.00	2N5922	10.00	MMCM918	20.00
2N3287	4.30	2N5942	46.00	MMT72	1.17
2N3294	1.15	2N5944	8.92	MMT74	1.17
2N3301	1.04	2N5945	12.38	MMT2857	2.83
2N3302	1.05	2N5946	14.69	MRF304	43.45
2N3304	1.48	2N6080	7.74	MRF420	20.00
2N3307	12.60	2N6081	10.05	MRF450	11.85
2N3309	3.90	2N6082	11.30	MRF450A	11.85
2N3375	9.32	2N6083	13.23	MRF454	21.83
2N3553	1.57	2N6084	14.66	MRF458	20.68
2N3755	7.20	2N6094	7.15	MRF475	5.00
2N3818	6.00	2N6095	11.77	MRF476	5.00
2N3866	1.09	2N6096	20.77	MRF502	1.08
2N3866JAN	2.80	2N6097	29.54	MRF504	6.95
2N3866JANTX	4.49	2N6136	20.15	MRF509	4.90
2N3924	3.34	2N6168	38.80	MRF511	8.15
2N3927	12.10	2N6265	75.00	MRF901	3.00
2N3950	26.86	2N6266	100.00	MRF5177	21.62
2N4072	1.80	2N6439	45.77	MRF8004	1.60
2N4135	2.00	2N6459/PT9795	18.00	PT4186B	3.00
2N4261	14.60	2N6603	12.00	PT4571A	1.50
2N4427	1.20	2N6804	12.00	PT4612	5.00
2N4429	7.50	A50-12	25.00	PT4628	5.00
2N4430	20.00	BFR90	5.00	PT4640	5.00
2N4957	3.62	BLY588C	25.00	PT8659	10.72
2N4958	2.92	BLY588CF	25.00	PT9784	24.30
2N4959	2.23	CD3495	15.00	PT9790	41.70
2N4976	19.00	HEP78/S3014	4.95	SD1043	5.00
2N5090	12.31	HEPS3002	11.30	SD1116	3.00
2N5108	4.03	HEPS3003	29.88	SD1118	5.00
2N5109	1.66	HEPS3005	9.95	SD1119	3.00
2N5180	3.49	HEPS3006	19.90	TA7993	75.00
2N5179	1.05	HEPS3007	24.95	TA7994	100.00
2N5184	2.00	HEPS3010	11.34	TRWMA2023-1.5	42.50
2N5216	47.50	HEPS5026	2.56	40281	10.90
2N5583	4.55	HP35831E/		40282	11.90
2N5589	6.82	HXTR5104	50.00	40290	2.48
		MM1500	32.20		

## CHIP CAPACITORS

	1pf	27pf	220pf	1200pf
	1.5pf	33pf	240pf	1500pf
	2.2pf	39pf	270pf	1800pf
	2.7pf	47pf	300pf	2200pf
	3.3pf	56pf	330pf	2700pf
	3.9pf	68pf	360pf	3300pf
	4.7pf	82pf	390pf	3900pf
	5.6pf	100pf	430pf	4700pf
	6.8pf	110pf	470pf	5600pf
	8.2pf	120pf	510pf	6800pf
	10pf	130pf	560pf	8200pf
	12pf	150pf	620pf	.010mf
	15pf	180pf	680pf	.012mf
	18pf	180pf	820pf	.015mf
	22pf	200pf	1000pf	.018mf

## ATLAS CRYSTAL FILTERS FOR ATLAS HAM GEAR

5.52-2.7/8  
5.595-2.7/8/U  
5.595-.500/4/CW  
5.595-2.7/LSS  
5.595-2.7/USB  
5.645-2.7/8  
9.0USB/CW

YOUR CHOICE \$24.95

# MHz electronics

**MOTOROLA Semiconductor The RF Line**

## MRF454

\$21.83

### NPN SILICON RF POWER TRANSISTORS

... designed for power amplifier applications in industrial, commercial and amateur radio equipment to 30 MHz.

- Specified 12.5 Volt, 30 MHz Characteristics –  
Output Power = 80 Watts  
Minimum Gain = 12 dB  
Efficiency = 50%

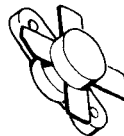

## MRF458

\$20.68

### NPN SILICON RF POWER TRANSISTOR

... designed for power amplifier applications in industrial, commercial and amateur radio equipment to 30 MHz.

- Specified 12.5 Volt, 30 MHz Characteristics –  
Output Power = 80 Watts  
Minimum Gain = 12 dB  
Efficiency = 50%
- Capable of Withstanding 30:1 Load VSWR @ Rated P<sub>out</sub> and V<sub>CC</sub>

### NPN SILICON RF POWER TRANSISTOR

... designed primarily for use in large-signal output amplifier stages. Intended for use in Citizen-Band communications equipment operating at 27 MHz. High breakdown voltages allow a high percentage of up-modulation in AM circuits.

- Specified 12.5 V, 27 MHz Characteristics –  
Power Output = 4.0 Watts  
Power Gain = 10 dB Minimum  
Efficiency = 65% Typical

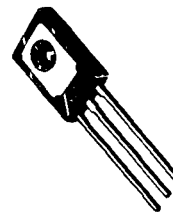

## MRF472

\$2.50

## MRF475

### NPN SILICON RF POWER TRANSISTOR

... designed primarily for use in single sideband linear amplifier output applications in citizens band and other communications equipment operating to 30 MHz.

- Characterized for Single Sideband and Large-Signal Amplifier Applications Utilizing Low-Level Modulation.
- Specified 13.6 V, 30 MHz Characteristics –  
Output Power = 12 W (PEP)  
Minimum Efficiency = 40% (SSB)  
Output Power = 4.0 W (CW)  
Minimum Efficiency = 50% (CW)  
Minimum Power Gain = 10 dB (PEP & CW)
- Common Collector Characterization

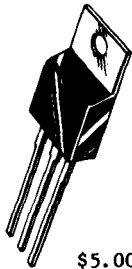

\$5.00

## MHW710 - 2

\$46.45

440 to 470MC

### UHF POWER AMPLIFIER MODULE

... designed for 12.5 volt UHF power amplifier applications in industrial and commercial FM equipment operating from 400 to 512 MHz.

- Specified 12.5 Volt, UHF Characteristics –  
Output Power = 13 Watts  
Minimum Gain = 19.4 dB  
Harmonics = 40 dB
- 50 Ω Input/Output Impedance
- Guaranteed Stability and Ruggedness
- Gain Control Pin for Manual or Automatic Output Level Control
- Thin Film Hybrid Construction Gives Consistent Performance and Reliability



## Tektronix Test Equipment

B	Wideband High Gain Plug In	\$ 51.00
CA	Dual Trace Plug In	150.00
K	Fast Rise DC Plug In	63.00
N	Sampling Plug In	200.00
R	Transistor Rise-time Plug In	116.00
W	High Gain Differential Comparator Plug In	283.00
TU-2	Test Load Plug In for 530/540/550 Main Frames	50.00
1A2	Wideband Dual Trace Plug In	216.00
151	Sampling Unit With 350PS Rise-time DC to 1GHZ	730.00
2A61	AC Differential Plug In	133.00
353	Dual Trace Sampling DC to 1GHZ Plug In	250.00
3576	Dual Trace Sampling DC to 875MHZ Plug In	250.00
3777A	Sampling Sweep Plug In	250.00
3E10	Spectrum Analyzer 1 to 36MHZ Plug In	1000.00
50	Amplifier Plug In	50.00
51	Sweep Plug In	50.00
53B	Wideband High Gain Plug In	25.00
53/54B	Wideband High Gain Plug In	45.00
53/54C	Dual Trace Plug In	112.50
53/54D	High Gain DC Differential Plug In	38.00
53/54G	Wideband DC Differential Plug In	68.00
53/54L	Fast Rise High Gain Plug In	68.00
84	Test Plug In for 580/581 Main Frames	75.00
107	Square Wave Generator, 4 to 1MHz	48.00
RM122	Preamplifier 2Hz to 40KHZ	63.00
123	AC Coupled Preamplifier	25.00
127	Power Supply For 2 Plug In's	148.00
131	Current Probe Amplifier	50.00
184	Time Mark Generator	363.00
R240	Program Control Unit	150.00
280	Trigger Countdown Unit	84.00
455	Portable Dual Trace 50MHZ Scope	2000.00
465	Portable Dual Trace 100MHZ Scope	2500.00
503	DC to 450KHZ Scope Rack Mount	250.00
535A	DC to 15MHZ Scope Rack Mount	263.00
543	DC to 33MHZ Scope	300.00
561	DC to 10MHZ Scope Rack Mount	150.00
561A	DC to 10MHZ Scope Rack Mount	200.00

## Scopes with Plug-ins

567	Digital Readout Scope with a 6R1A Digital Unit and a 3S3 Dual Trace DC to 1GHZ Sampling Plug In and a 3777A Sweep Plug In.	750.00
561A	DC to 10MHZ Scope with a 3576 Dual Trace DC to 875MHZ Sampling Plug In and a 3777A Sweep Plug In. Rack Mount	600.00
565	DC to 10MHZ Dual Beam Scope with a 2A63 Diff. and a 2A61 Diff. Plug In's.	900.00
581	DC to 80MHZ Scope with a 82 Dual Trace High Gain Plug In	650.00
661	Sampling Scope with a 513 Timing Plug In and a 452 Dual Trace DC to 3.5GHZ Sampling Plug In.	575.00

## Tubes

2E26	\$ 5.00	4CX350FJ	\$116.00	6146W	12.00
3-5002	102.00	4CX1000A	300.00	6159	10.50
3-1000Z	266.00	4CX1500B	350.00	6161	75.00
3B2B/866A	5.00	4CX1500DA	750.00	6293	18.50
3X2500A3	150.00	4E27	50.00	6360	6.95
4-65A	45.00	4X150A	41.00	6907	40.00
4-125A	58.50	4X150D	52.00	6939	14.75
4-250A	68.50	4X150G	74.00	7360	12.00
4-400A	71.00	5Z2B/T160L	39.00	7984	10.40
4-1000A	194.00	6LF6	5.00	8072	49.00
5-500A	145.00	6L06	5.00	8106	2.00
4CX250B	65.00	811A	12.95	8156	7.85
4CX250F/G	55.00	813	29.00	8226	127.70
4CX250K	113.00	5894/A	42.00	8295/PL172	328.00
4CX250R	92.00	6146	5.00	8458	25.75
4CX300A	147.00	6146A	6.00	8560A/AS	50.00
4CX350A	107.00	6146B/8298A	7.00	8908	9.00
				8950	9.00

## MICROWAVE COMPONENTS

## COMPUTER I.C. SPECIALS

### ARRA

2416	Variable Attenuator	\$ 50.00
3614-60	Variable Attenuator 0 to 60dB	75.00
KU520A	Variable Attenuator 18 to 26.5 GHz	100.00
4684-20C	Variable Attenuator 0 to 180dB	100.00
6684-20F	Variable Attenuator 0 to 180dB	100.00

### General Microwave

Directional Coupler 2 to 4GHz 20dB Type N	75.00
---	-------

### Hewlett Packard

H487B	100 ohms Neg. Thermistor Mount (NEW)	150.00
H487B	100 ohms Neg. Thermistor Mount (USED)	100.00
477B	200 ohms Neg. Thermistor Mount (USED)	100.00
X487A	100 ohms Neg. Thermistor Mount (USED)	100.00
X487B	100 ohms Neg. Thermistor Mount (USED)	125.00

J468A	100 ohms Neg. Thermistor Mount (USED)	150.00
478A	200 ohms Neg. Thermistor Mount (USED)	150.00
8478A	200 ohms Balanced Neg. Thermistor Mount (USED)	175.00
J382	5.85 to 8.2 GHz Variable Attenuator 0 to 50dB	250.00
X382A	8.2 to 12.4 GHz Variable Attenuator 0 to 50dB	250.00

X885A	8.2 to 12.4 GHz Phase Shifter +/- 360°	250.00
394A	1 to 2 GHz Variable Attenuator 6 to 120dB	250.00
NK292A	Waveguide Adapter	65.00
K422A	18 to 26.5 GHz Crystal Detector	250.00
K375A	18 to 26.5 GHz Variable Attenuator	300.00
8436A	Bandpass Filter 8 to 12.4 GHz	75.00

8439A	2 GHz Notch Filter	75.00
8471A	RF Detector	50.00
342A	VHF Noise Source	100.00
X347A	8.2 to 12.4 GHz Noise Source	250.00
H532A	7.05 to 10 GHz Frequency Meter	300.00
G532A	3.95 to 5.85 GHz Frequency Meter	300.00
J532A	5.85 to 8.2 GHz Frequency Meter	300.00

809A	Carriage with a 444A Slotted Line Untuned Detector Probe and 809B Coaxial Slotted Section 2.6 to 18 GHz	175.00
809B	Carriage with a 442B Broadband Probe 2.6 to 12.4 GHz and a X810B Slotted Section	200.00
809B	Carriage with a X810B Slotted Section and a PRD 250A Detector Mount 2.4 to 12.4 GHz	200.00

### Merrimac

AU-25A/	801115 Variable Attenuator	100.00
AU-26A/	801162 Variable Attenuator	100.00

### Microlab/FXR

Y410A	Frequency Meter 12400 - 18000 MC	250.00
N414A	Frequency Meter 3950 - 11000 MC	350.00
6638S	Horn 8.2 - 12.4 GHz	60.00
601-B18	X to N Adapter 8.2 - 12.4 GHz	35.00
Y610D	Coupler	75.00

### Narda

3095/	22909 Directional Coupler 7 to 12.4 GHz 10dB Type N	250.00
4013C-10/	22540A Directional Coupler 2 to 4 GHz 10dB Type SMA	90.00
4014-10/	22538 Directional Coupler 3.85 to 8 GHz 10dB Type SMA	90.00
4014C-6/	22876 Directional Coupler 3.85 to 8 GHz 6dB Type SMA	90.00
4015C-10/	22539 Directional Coupler 7.4 to 12 GHz 10dB Type SMA	95.00
4015C-30/	23105 Directional Coupler 7 to 12.4 GHz 30dB Type SMA	95.00
3044-20	Directional Coupler 4 to 8 GHz 20dB Type N	125.00
3040-20	Directional Coupler 240 to 500 MC 20dB Type N	125.00
3041-20	Directional Coupler 500 to 1000 MC 20dB Type N	125.00
3043-20/	22006 Directional Coupler 1.7 to 4 GHz 20dB Type N	125.00
3003-10/	22011 Directional Coupler 2 to 4 GHz 10dB Type N	75.00
3003-30/	22012 Directional Coupler 2 to 4 GHz 30dB Type N	75.00
3042-20	Directional Coupler 950 to 2 GHz 20dB Type N	125.00
3043-30/	22007 Directional Coupler 1.7 to 3.5 GHz 30dB Type N	125.00
22574	Directional Coupler 2 to 4 GHz 10dB Type N	125.00
3033	Coaxial Hybrid 2 to 4 GHz 3dB Type N	125.00
3032	Coaxial Hybrid 950 to 2 GHz 3 dB Type N	125.00
784/	22380 Variable Attenuator 1 to 90dB 2 to 2.5 GHz Type SMA	550.00
22377	Waveguide to Type N Adapter	35.00
720-6	Fixed Attenuator 8.2 to 14.4 GHz 6 dB	50.00
3503	Waveguide	25.00

### PRD

U101	12.4 to 18 GHz Variable Attenuator 0 to 60dB	300.00
X101	8.2 to 12.4 GHz Variable Attenuator 0 to 60dB	200.00
C101	Variable Attenuator 0 to 60dB	200.00
205A/367	Slotted Line with Type N Adapter	100.00
195B	8.2 to 12.4 GHz Variable Attenuator 0 to 50dB	100.00
185B1	7.05 to 10 GHz Variable Attenuator 0 to 40dB	100.00
196C	8.2 to 12.4 GHz Variable Attenuator 0 to 45dB	100.00
170B	3.95 to 5.85 GHz Variable Attenuator 0 to 45dB	100.00
588A	Frequency Meter 5.3 to 6.7 GHz	100.00
140A,C,D,E	Fixed Attenuators	25.00
109J,I	Fixed Attenuators	25.00
WEINSCHEL ENG.	2692 Variable Attenuator +30 to 60dB	100.00

### MEMORY

MEMORY	DESCRIPTION	PRICE
2708	1K x 8 EPROM	\$ 7.99
2716/2516	2K x 8 EPROM 5Volt Single Supply	20.00
2114/9114	1K x 4 Static RAM 450ns	6.99
2114L2	1K x 4 Static RAM 250ns	8.99
2114L3	1K x 4 Static RAM 350ns	7.99
4027	4K x 1 Dynamic RAM	3.99
4060/2107	4K x 1 Dynamic RAM	3.99
4050/9050	4K x 1 Dynamic RAM	3.99
2111A-2/8111	256 x 4 Static RAM	3.99
2112A-2	256 x 4 Static RAM	3.99
2115AL-2	1K x 1 Static RAM 55ns	4.99
6104-3/4104	4K x 1 Static RAM 320ns	14.99
7141-2	4K x 1 Static RAM 200ns	14.99
MCM6641L20	4K x 2 Static RAM 200ns	14.99
9131	1K x 1 Static RAM 300ns	10.99

### C.P.U.'s ECT.

MC6800L	Microprocessor	13.80
MCM6810AP	128 x 8 Static RAM 450ns	3.99
MCM68A10P	128 x 8 Static RAM 360ns	4.99
MCM68B10P	128 x 8 Static RAM 250ns	5.99
MC6820P	PIA	8.99
MC6820L	PIA	9.99
MC6821P	PIA	8.99
MC68B21P	PIA	9.99
MCM6830L7	Microbug	14.99
MC6840P	PTM	8.99
MC6845P	CRT Controller	29.50
MC6845L	CRT Controller	33.00
MC6850L	ACIA	10.99
MC6850P	ACIA	4.99
MC6852P	SSDA	5.99
MC6852L	SSDA	11.99
MC6854P	ADLC	22.00
MC6860CJCS	0-600 BPS Modem	29.00
MC6862L	2400 BPS Modem	14.99
MK3850N-3	F8 Microprocessor	9.99
MK3852P	F8 Memory Interface	16.99
MK3852N	F8 Memory Interface	9.99
MK3854N	F8 Direct Memory Access	9.99
8008-1	Microprocessor	4.99
8080A	Microprocessor	8.99
Z80CPU	Microprocessor	14.99
6520	PIA	7.99
6530	Support For 6500 series	15.99
2650	Microprocessor	10.99
TMS1000NL	Four Bit Microprocessor	9.99
TMS4024NC	9 x 64 Digital Storage Buffer (FIFO)	9.99
TMS6011NC	UART	9.99
MC14411	Bit Rate Generator	11.99
AY5-4007D	Four Digit Counter/Display Drivers	8.99
AY5-9200	Repertory Dialler	9.99
AY5-9100	Push Button Telephone Diallers	7.99
AY5-2376	Keyboard Encoder	19.99
AY3-8500	TV Game Chip	5.99
TR1402A	UART	9.99
PR1472B	UART	9.99
PT1482B	UART	9.99
8257	DMA Controller	9.99
8251	Communication Interface	9.99
8228	System Controller & Bus Driver	5.00
8212	8 Bit Input/Output Port	5.00
MC14410CP	2 of 8 Tone Encoder	9.99
MC14412	Low Speed Modem	14.99
MC14408	Binary to Phone Pulse Converter	12.99
MC14409	Binary to Phone Pulse Converter	12.99
MC1488L	RS232 Driver	1.00
MC1489L	RS232 Receiver	1.00
MC1405L	A/D Converter Subsystem	9.00
MC1406L	6 Bit D/A Converter	7.50
MC1408/6/7/8	8 Bit D/A Converter	4.50
MC1330P	Low Level Video Detector	1.50
MC1349/50	Video IF Amplifier	1.17
MC1733L	LM733 OP Amplifier	2.40
LM565	Phase Lock Loop	2.50

# MHz electronics

(602) 242-3037

(602) 242-8916

2111 W. Camelback

Phoenix, Arizona 85015

## These CRYSTAL FILTERS are for you!

### 600 Hz 6-Pole First -IF Filter for Drake R-4C

Optimum bandwidth, low loss. Improve the early-stage selectivity. Eliminate those high pitched beat notes from signals that leak around the switchable second -IF filter. Improve ultimate rejection to better than 140 dB. Eliminate the chance of strong signals overloading the second mixer, causing intermodulation and desensitization. Both the existing filter and our CF-600/6 can be mounted in the receiver and relay switched to retain phone capabilities. CF-600/6 \$80.00. Relay switch kit: \$39.00.

### Superior 8-Pole CW Selectivity for TR-4s

350 Hz at -6 dB, 850 Hz at -60 dB. Cuts ORM. More selective than 6-pole CW filter in TR-4Cw. For all TR-4s: S/N 26,000 and above. CF-350/8 \$120.00. Switch and mounting kit: \$10.00.

### Signal/One CX-7, CX-11 8-Pole CW Filter

All purpose CW bandwidth, low loss, 350 Hz. Ideal for RTTY. CS-350/8. \$120.00.

ATLAS OWNERS: Upgrade or repair your rig with our 2200- or 2700- Hz 8-pole crystal filters. Wider bandwidth identical to original Atlas filter. Narrower bandwidth for today's ORM. CA-2.7K/8 or CA-2.2K/8. \$80.00.

European amateurs: please contact Ham Radio, Postfach 120, CH-5702, Niederlenz, in Switzerland, and Ingomplex, Postfach 24 49, D-8070, Ingolstadt, West Germany, for the rest of the continent.

### 16-Pole R-4C SSB!

New plug-in 16-pole second-IF filter. Optimum bandwidth, low loss. Improve selectivity, reduce ORM. Ideal for DX and contest work. Maximum skirt selectivity with maximum intelligibility. Shape factor 1.3. Less than 2000 Hz at -6 dB, less than 2600 Hz at -60 dB. Plugs directly into accessory socket on rear of set. CF-2K/16 \$135.00.

### 3kHz 8-Pole Filter for R-4C, R-7, TR-7

Sharpest AM filter, also wideband SSB in 7-line. Optional two AM filter relay switch kit for R-4C. \$39.00. CF-3K/8 for R-4C, CD-3K/8 for R-7, TR-7. \$80.00.

### Sherwood Engineering Inc.

1268 South Ogden St.  
Denver, Colo. 80210  
(303) 722-2257

Money back if not satisfied

Add \$3 per order shipping;  
\$6 overseas air

Dealer Inquiries Welcome



## SL-56 AUDIO ACTIVE FILTER



\$79.00

ppd  
USA &  
Canada

## FOUR FILTERS IN ONE AT THE SAME TIME

Call, Write or SEE  
Another ISSUE for Details

ELECTRONICS RESEARCH CORP. OF VIRGINIA  
P. O. BOX 2394  
VIRGINIA BEACH, VIRGINIA 23452  
TELEPHONE (804) 463-2659

# Radio World

CENTRAL NEW YORK'S FASTEST GROWING HAM DEALER



Featuring Yaesu, Icom, Drake, Ten-Tec, Swan, DenTron, Kenwood, KDK, MFJ, Microwave Module, Tempo, Astron, KLM, Hy-Gain, Mosley, Larsen, Cushcraft, Hustler, Mini Products, Bird, DSI, Mirage, Vibroplex, Bencher, Info-Tech, Universal Towers, Callbook, ARRL, Astatic, Shure. We service everything we sell! Write or call for quote. You Won't be Disappointed. We are just a few minutes off the NYS Thruway (I-90) Exit 32

ONEIDA COUNTY AIRPORT TERMINAL BUILDING  
ORISKANY, NEW YORK 13424

Warren  
K2IXN  
Call Toll Free: 1-800-448-7914

Bob  
WA2MSH  
New York State Residents Call 315-337-2622 or 315-337-0203

## SYNTHESIZED SIGNAL GENERATOR



- Covers 100 to 179,999 MHz in 1 kHz steps with thumb-wheel dial
- Accuracy .00001% at all frequencies
- Internal frequency modulation from 0 to over 100 kHz at a 1 kHz rate
- Spurs and noise at least 60dB below carrier
- RF output adjustable from 50 to 500mv across 50 ohms
- Operates on 12vdc @ 1/2 amp
- Price \$299.95 plus shipping.

In stock for immediate shipping. Overnight delivery available at extra cost. Phone: (212) 468-2720.

**VANGUARD LABS**  
196-23 Jamaica Ave. Hollis, NY 11423



VJ90SSB

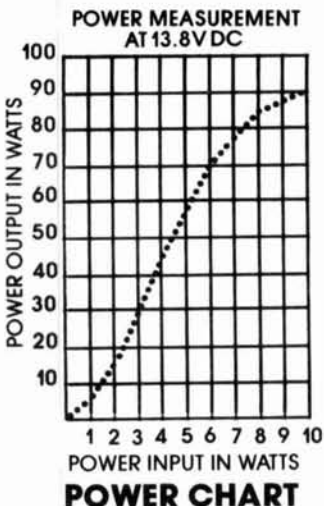

## POWER-UP FOR ONLY \$79.95 AMPLIFIER ONLY

### SPECIAL PACKAGE DEAL

### FACTORY DIRECT ONLY

That's right - 90 watts of linear power for 2 meters for only \$79.95. Check out the VJ90SSB Power Chart, and you'll see the real value - 8 watts out for one watt drive, 16 out with two watts drive! Now you can put that new HT to mobile use, for only \$79.95. As a special deal, we've designed a 19dB gain in-line preamp with integrated T/R relay. A \$29.95 value, for only \$20.00 when purchased with the VJ90SSB Amplifier.

But that's not all! We've built a 15 amp (20 amp surge) 13.8VDC power supply just for this combo, the VJ15. When you buy the VJ90SSB and Preamp, we'll sell you this super power supply for only \$79.95. It all adds up to over \$225.00 worth of gear for only \$179.90. Don't wait. Order Today!



VJ15

Each VJ Product component is hand wired and individually tuned for maximum reliability and performance. VJ Products are guaranteed to be free of defects in parts or workmanship for 1 year from the date of purchase. POWER TRANSISTORS ARE EXCLUDED. BUT WARRANTED FOR 90 DAYS. Visa accepted. Immediate shipment guaranteed by VJ Products, Inc.

Please ship:  VJ90SSB @ \$79.97 + \$2.00 shipping  
 VJ90SSB/Preamp @ \$99.95 + \$3.50 shipping  
 VJ15 P/S @ \$79.95 + \$2.50 shipping

Name \_\_\_\_\_ Call \_\_\_\_\_  
Street \_\_\_\_\_  
City \_\_\_\_\_ State \_\_\_\_\_ Zip \_\_\_\_\_  
Send Check, M/O, or Visa # \_\_\_\_\_ Exp. Date \_\_\_\_\_

# flea market



SB-102 w/SB-600 ps, \$350.00; R-390, \$350.00; HW-101 w/HP23 ps, \$275.00. After 5:00 PDT (707) 526-6276.

**SPECIAL SALE:** Alliance HD-73 Heavy Duty Rotor \$99.99 plus \$3.00 shipping Continental USA. MC and Visa accepted. Scanner World, USA., 10-H New Scotland Ave., Albany, NY 12208. 518-436-9606.

**BUY, SELL, TRADE** ham, computer, miscellaneous new, used electronic gear. Over 1000 items each month. Subscription \$5.00. Free classified ad with subscription. Dealer inquiries invited. Nuts & Volts, Box 1111-F, Placentia, California 92670.

**RECONDITIONED TEST EQUIPMENT** for sale. Catalog \$5.00. Walter, 2697 Nickel, San Pablo, CA 94806.

**DRAKE "B" line** in mint condition. R4B, T4XB, AC4, MS4 with 10M, 160M, and 10 MHz crystals. \$700.00. Rick Markey, WB3CFG, Lebanon, PA. 717-272-8763.

**HP 416A Ratio Meter \$10.** HP 415A SWR Meter \$22. HP 430A Power Meter, defective \$15. Transformer 3 KV CT, 35 lbs. Kurt Bittmann, WB2YVY, 147 McGaw Ave., Centereach, NY 11720. (516) 585-9775.

**WANTED:** Microwave Dish 6 feet or larger. Willis, W9FGJ, 402 E. Cole St., DuQuoin, Il. 62832. (618) 542-2274.

**STOP LOOKING** for a good deal on amateur radio equipment — you've found it here — at your amateur radio headquarters in the heart of the Midwest. Now more than ever where you buy is as important as what you buy. We are factory-authorized dealers for Kenwood, Drake, Yaesu, Collins, Wilson, Ten-Tec, ICOM, DenTron, MFJ, Tempo, Regency, Hy-Gain, Mosley, Alpha, CushCraft, Swan and many more. Write or call us today for our low quote and try our personal and friendly Hoosier Service. HOOSIER ELECTRONICS, P.O. Box 2001, Terre Haute, Indiana 47802. (812) 238-1458.

**CB TO 10 METER PROFESSIONALS:** Your rig or buy ours — AM/SSB/CW. Certified Communications, 4138 So. Ferris, Fremont, Michigan 49412; (616) 924-4561.

**MOTOROLA ALL SOLID-STATE MOTRAN RADIOS.** Model X43LSN-2170, 70 frequency, transmit 150 MC (30W), receive 450 MC. Will operate in Ham Bands. No modification required. Large stock available. \$150.00 each. Omni Communications. Call (312) 852-0738.

**QSL'S:** No stock designed! Your art or ours; photos, originals, 50¢ for samples & details (refundable). Certified Communications, 4138 So. Ferris, Fremont, Michigan 49412.

**HAM RADIO REPAIR,** alignment. Prompt, expert, reasonable. "Grid" Gridley, W4GJO, Route 2, Box 138B, Rising Fawn, GA 30738.

**TRANSMITTER TECHNICIANS:** Voice of America has opportunities for qualified technicians at VOA stations near Delano, California, and Greenville, North Carolina. Duties include operations/maintenance of high power shortwave transmitters and related facilities on shift basis. Minimum qualifications: 3-years chief broadcast engineer 5 to 50 KW, or 3-years supervisor of operations/maintenance high power military transmitting plant, or equivalent. U.S. citizenship required. Starting salary \$18,700. Submit standard Federal application form, SF-171, to International Communication Agency, MGT/PDE (1-78) Washington, D.C. 20547. An Equal Opportunity Employer.

**NEED HELP** for your Novice or General ticket? Recorded audio-visual theory instruction. No electronic background required. Free information. Amateur License, P.O. Box 6015, Norfolk, VA 23508.

**ANTIQUE (PRE-1950) TELEVISION SETS WANTED.** Will pay top dollar for unusual or pre-WWII sets, Arnold Chase, 9 Rushleigh Road, West Hartford, Connecticut 06117 (203) 521-5280.

**WANTED:** Early Hallicrafter receivers, transmitter, accessories, parts, manuals for my collection. Special interest in silver colored panel receivers and ones with "airplane" dials. Also need "ultra Skyriider" SX-10, "Skyriider Commercial" SX-12 and others. Chuck Dachis, WD5EOG, 4500 Russell, Austin, TX 78745.

**RADIO BROADCAST TECHNICIANS:** Voice of America has opportunities in Washington, D.C. for qualified Radio Broadcast Technicians. These positions require a comprehensive background in the recording, maintenance, studio and field areas. Salary range: \$10.59-\$14.87 per hour depending on qualifications. U.S. citizenship required. Submit standard Federal application form, SF-171, to International Communication Agency, MGT/PDE (1-78) Washington, D.C. 20547. An Equal Opportunity Employer.

**WANTED:** EICO #720 or #723 xmtr, Hallicrafter HT40 xmtr and HA5 vfo. J. Titus, Box 242, Blacksburg, VA 24060 (703) 952-2684.

**VARIABLE POWER SUPPLY KITS**  
 12-28 VDC ADJ @ 250 MA  
 5-12 VDC ADJ @ 500 MA  
**PARTS INCLUDED ARE:**  
 \* TRANSFORMER \* PC BOARD  
 \* POT & RESIS. \* HEAT SINK  
 \* 1000UF35VDC \* DIODES  
 \* REG. 7805-7812 \* HARDWARE  
 \* OSC. SUP. CAP. \* INSTRUCTION  
 12-28VDC PS-0074 \$7.95  
 5-12VDC PS-0073 \$7.95

**Miniature Toggle Switches**  
 1 EA. 10 EA.  
 SPDT \$1.00 \$8.95  
 DPDT \$1.50 \$12.95

**DIODES**

PIV AMP	COST
100	5/\$1.00
100	12 3/\$1.00
100	40 \$1.35
600 450	\$18.50

**2200UF 16VDC 25¢**

**LED JUMBO'S** RED  
 1 FOR \$1.00  
 100 FOR \$7.95

**SOUND ALERT**  
 6-28 VDC  
 3-14 MA  
 \$4.95

SEND FOR NEW CATALOG

**FANS** 100 CFM  
 115VAC 60HZ  
 4.5" X 1.5"  
 USED \$6.95  
 GUARANTEED  
 NEW \$12.95

**MPF-131**  
 N-CHANNEL DUAL GATE  
 MOS-FET GOOD FOR 60  
 & 200MHZ. DATA SHEET  
 INCLUDED. MARKED. **50¢**

**Touch-Tone Housing.**  
 BLACK only...\$3.50

**50 ohm COAX**  
 RG 174U 25 FT.  
 \$1.75

**.1OHM 5WATT RESISTORS**  
 5 FOR \$1.00

**BRIDGES**  
**25 AMP.**  
 50 PIV  
 \$1.75 EA. 3 FOR \$5.00

**POWER SUPPLY MODULE**  
 RATED AT 12V @ 2.5A. CAN  
 BE MODIFIED BY CHANGING  
 THE ZENER.  
 PARTS: 4-3A DIODES, 1-2.5A  
 FUSE, 1-2200MF @ 35V CAP,  
 1-12V ZENER, 1-PASS TRANS.  
 WITH HEAT SINK. \$4.95

**HIGH VOLTAGE SUPPLY**  
 15KVDC @ 30 WATTS  
 INPUT 115VAC 60HZ  
 \$9.95

**COAX RELAY**  
 12 VDC SPDT  
 450 OHM @ 100 WATTS  
 COAX BNC 2 POS. 1/8" DIA  
 CONTACT. \$6.95

**ANTENNAS**

**ANTENNAS**

ANS PTBS	BNC STRAIGH
ANS PTUS	UHF STRAIGH
ANS PTB90	BNC 90° ELBOW
ANS PTU90	UHF 90° ELBOW
ANS PTBAJ	BNC ADJ ELBOW
ANS PTUAJ	UHF ADJ ELBOW

**\$7.95**  
 ALL ANTENNAS ARE FOR TWO METERS

**UHF 90° F/M** M359 \$2.50  
**UHF 12° F/M** M358 \$2.95  
**BNC 90° F/M** UG306 \$3.75  
**BNC 12° F/M** UG274 \$4.00  
**UHF-M/UHF-M** DM-1 \$2.50  
**UHF-F/UHF-F** PL258 \$1.50  
**BNC-M/BNC-M** UG491 \$3.85  
**BNC-F/BNC-F** UG914 \$2.25  
**BNC-F/CABLE** UG1094 \$1.00  
**BNC-M/CABLE** UG88 \$1.35  
**BNC-F/UHF-M** UG273 \$3.00  
**BNC-M/UHF-F** UG255 \$3.50

**MIX & MATCH**  
 10-\$6.00

**UHF-25P/PANEL** \$1.65  
**UHF-M/CABLE** \$1.65  
**BNC-12° F/M** \$1.50  
**BNC-90° F/M** \$1.25

**Marlin P. Jones & Assoc.**  
 P.O. Box 12685-E  
 Lake Park, Fl. 33403  
 (305) 848-8236

MC, VISA, COD ACCEPTED  
 \*ADD \$1. ORDERS UNDER \$10. \*FLA. RES. 4% SALE TAX  
 PLEASE ADD SUFFICIENT POSTAGE

**RATES** Non-commercial ads 10¢ per word; commercial ads 60¢ per word both payable in advance. No cash discounts or agency commissions allowed.

**HAMFESTS** Sponsored by non-profit organizations receive one free Flea Market ad (subject to our editing). Repeat insertions of hamfest ads pay the non-commercial rate.

**COPY** No special layout or arrangements available. Material should be typewritten or clearly printed (not all capitals) and must include full name and address. We reserve the right to reject unsuitable copy. Ham Radio cannot check each advertiser and thus cannot be held responsible for claims made. Liability for correctness of material limited to corrected ad in next available issue.

**DEADLINE** 15th of second preceding month.

**SEND MATERIAL TO:** Flea Market, Ham Radio, Greenville, N.H. 03048.

**10-40 MHz SYNTHESIZER** provides continuous coverage 1-31 MHz in 100 Hertz steps with your 9-MHz I-F. PCB, kit, or wired. SASE for data sheet. Petlit Logic Systems, P.O. Box 51, Oak Harbor, WA 98277.

**WANTED:** Millen ant. bridge model 90672, complete. For sale: Ten-Tec Omni D "digital" series "B." filters, N.B., 20 amp supply, manual & cartons. \$1135.00. Jim Gysan, W1VYB (617) 922-3850 after 5:30 PM.

**MOBILE HF ANTENNA** 3.2-30 MHz inclusive, 750 watts PEP, center loaded, tuned from the base, eliminating coil changing or removing from mount. Less than 1.5 to 1 VSWR thru entire coverage. \$129.95 ea. plus shipping. Contact your local dealer, if none in your area order direct. Anteck, Inc., Route One, Hansen, Idaho 83334. (208) 423-4100. Master Chg., and VISA accepted. Dealer and factory rep. inquiries invited.

**XTAL FILTERS:** C-F Networks 9 MHz SSB filter — 2.1 kHz BW, similar to KVG XF9-B, \$25 postpaid. K8DRN, J. Wiggenhorn, 1878 NW 84th Dr., Coral Springs, FL 33065. 305-752-7444.

**VERY in-ter-est-ing!** Next 3 issues \$1. "The Ham Trader", Wheaton, IL 60187.

## Foreign Subscription Agents for Ham Radio Magazine

Ham Radio Austria  
 F. Baerl  
 Hauptplatz 5  
 A-2700 Wiener Neustadt  
 Austria

Ham Radio Holland  
 MRI Electronics  
 Postbus 58  
 NL-2204 Delft  
 Holland

Ham Radio Belgium  
 Stereohouse  
 Brusselsesteenweg 418  
 B-8218 Gent  
 Belgium

Ham Radio Italy  
 G. Vulpetti  
 P.O. Box 37  
 I-22063 Cantu  
 Italy

Ham Radio Canada  
 Box 400, Goderich  
 Ontario, Canada N7A 4C7

Ham Radio Switzerland  
 Karin Ueber  
 Postfach 2454  
 D-7850 Loerrach  
 West Germany

Ham Radio Europe  
 Box 444  
 S-194 04 Upplands Vasby  
 Sweden

Ham Radio UK  
 P.O. Box 83, Harrow  
 Middlesex HA3 6HS  
 England

Ham Radio Germany  
 Karin Ueber  
 Postfach 2454  
 D-7850 Loerrach  
 West Germany

Holland Radio  
 143 Greenway  
 Greenside, Johannesburg  
 Republic of South Africa

**FREE!**  
**RADIO AMATEURS**  
**WORLD ATLAS**  
 with purchase of famous  
**CALLBOOK**  
**MAP LIBRARY!**

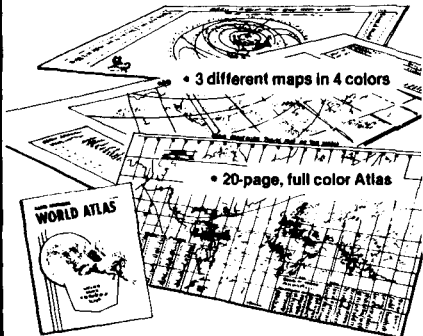

Here's an offer you can't refuse! You receive three, information-packed, Amateur Callbook maps, folded, plus the World Atlas for only \$4.50 plus \$1.50 shipping and handling. If purchased separately, total value of map/atlas offer would be \$7.50 plus shipping. You save \$3.00 and get these invaluable radio amateur aids!

- 1. Prefix Map of the World, folded.** World-wide prefixes. Shows 40-zone map on one side, 90-zone map on the other. Size 40" x 28"
- 2. Map of North America, folded.** Includes Central America and Caribbean to the Equator. Shows call areas, zone boundaries, prefixes, etc. Size 30" x 25"
- 3. Great Circle Chart of World, folded** Centered on 40° N, 100° W. Shows cities, latitude, longitude, great circle bearings and more! Size 30" x 25"

**Plus special FREE bonus!**  
 The Callbook's own Radio Amateur World Atlas, FREE with the purchase of the 3 maps. Contains eleven full color maps of the world, looking at things from the radio amateurs point of view.

Callbook Map Library	\$4.50
Shipping	1.50
<b>Total</b>	<b>\$6.00</b>

**Special Offer!**  
**Amateur Radio Emblem Patch**  
 only \$2.50 prepaid



Pegasus on blue field, red lettering. 3" wide x 3" high. Great on jackets and caps. Sorry, no call letters.

**ORDER TODAY!**

Order from your favorite electronics dealer or direct from the publisher. All direct orders add \$1.50 for shipping. Illinois residents add 5% Sales Tax.

**RADIO AMATEUR**  
**callbook inc.**  
 Dept. FN  
 925 Sherwood Drive  
 Lake Bluff, Ill. 60044

**KLM Echo II** with factory installed preamp, 15 w. final, LSB \$185.00. Also, new 4-125A's \$20.00 each. Ray Schall, 1850 Olive Barber Rd., Coos Bay, OR 97420.

**MANUALS** for most ham gear 1937/1970. Send 25¢ for "Manual Catalog." H.I., Inc., Box H864, Council Bluffs, Iowa 51502.

**DECODE** Morse automatically. Improve speed, measure difficult signals. Microcomputer electronics, features unavailable commercially. SASE: Seastron, Box 1185, East Dennis, MA 02641.

**MOBILE IGNITION SHIELDING** provides more range with no noise. Available most engines. Many other suppression accessories. Literature, Estes Engineering, 930 Marine Dr., Port Angeles, WA 98362.

**FOR SALE:** Shakespeare 2m fiberglass antenna, model #58-03, 6dB gain, \$40.00, like new. Cushcraft AFM-4D 2m, four pole array, 9dB gain, 1 kW, \$50.00. ADC Audio Equalizer, like new, \$45.00. TRS-80, system desk, \$150.00 new. Mitchell Rakoff, 64-33 98th St., Rego Park, NY 11374.

**BUY-SELL-TRADE.** Send \$1.00 for catalog. Give name address and call letters. Complete stock of major brands new and reconditioned amateur radio equipment. Call for best deals. We buy Collins, Drake, Swan, etc. Associated Radio, 8012 Conser, Overland Park, KS 66204. (913) 381-5900.

**G.E., RCA, MOTOROLA** low band factory manuals, \$5 each. 2 Way radio & microwave test equipment, SASE for list. G.E. prog. control & cable \$10. T-supply \$8. K6KZT, 2255 Alexander, Los Osos, CA 93402.

**CW/SSB FILTERS:** IC audio install in any radio, sharp CW, stagger tuned SSB — \$15, \$32. SASE info: W8CBR, 80 W. Mennonite, Aurora, OH 44202.

**DRAKE R4B, T4XB, C4, LB4,** complete \$1200. Sound Technology ST-1000A FM/MPX Gen., \$1000. Like new. Will ship UPS. W9HFR, 414-646-3686 Eves. 1236 Mill Road, Delafield, WI 53018.

**FREE HAM/COMPUTER NEWSLETTER:** Send self-addressed stamped envelope for your copy. W5YI, P.O. Box #10101; Dallas, Texas 75207.

**SATELLITE TELEVISION:** Build or buy your own earth station. Article gives much hard to find, necessary information. Send \$3.00. Satellite Television, R.D. 3, Box 140, Oxford, NY 13830.

**THE MOR-GAIN HD DIPOLES** are most advanced, highest performance multi-band HF dipole antennas available. Patented design provides length one-half of conventional dipoles. 50 ohm feed on all bands, no tuner or balun required. Can be installed as inverted VEE. Thousands in use world wide. 22 models available including two models engineered for optimum performance for the novice bands. The Mor-Gain HD dipoles N/T series are the only commercial antennas specifically designed to meet the operational requirements of the novice license. Our 1-year warranty is backed by nearly 20 years of HD dipole production experience. Write or call today for our 5-page brochure. (913) 682-3142. Mor-Gain, P.O. Box 329H, Leavenworth, KS 66048.

**KENWOOD INTERNATIONAL USER'S CLUB.** Details S.A.S.E. NBRT, Pohorence, 9600 Kickapoo Pass, Streetsboro, OH 44240.

**DX, YOU BET! THE DX BULLETIN** — Best weekly DX info in the world. For FREE sample copy, send business-size SASE to: The DX Bulletin, 308 Vernon Avenue, Vernon, Connecticut 06066.

## Coming Events

**NEW JERSEY:** South Jersey Radio Association's 32nd annual Hamfest on September 7th at the Pennsauken Senior High School, Pennsauken, NJ. Flea market, prize drawings, contests, food and drink available. Indoor facilities if inclement weather. Admission: \$3.00. Starts: 9:00 AM. Talk-in on 146.52 simplex, 146.22/82 Repeater. More info: Edwin T. Kephart, 4309 Willis Ave., Pennsauken, NJ 08109.

**NEW YORK:** HAM-O-RAMA '80 on September 12th and 13th at the Erie County Fairgrounds in Hamburg. Exhibits, tech programs, prizes, flea market. Plenty of free parking, free RV hookups. Advance tickets \$3 — contact Ron Brodowski, KC2P, 260 Hilltop Drive, Elma, NY 14059. (716) 652-6754.

**NEW HAMPSHIRE:** C.V.F.M. Hamfest on September 28 at the King Ridge Ski Area, Sutton, NH (follow signs off of I-93). Admission: \$3.00. Giant flea market, florist exhibit for the girls, dealer's exhibit, food, overnight camping available, door prizes and much more. More info: C.A. Breuning, 54 Myrtle St., Newport, NH 03773.

## Alaska Microwave Labs

4335 E. 5TH STREET  
 ANCHORAGE, ALASKA 99504  
 (907) 338-0340

### TRANSISTORS

MRF901 FT4.5GHZ	\$ 3.25
8FR00 FT5.0GHZ	\$ 3.00
NEC 02137 FT4.5GHZ	\$ 3.25

### HOT CARRIER DIODES

MBD101 UHF—MICROWAVE	\$ 1.50
ND4131 4GHZ NF—5.75 DB	\$13.25
4GHZ NF— 6.5 DB	\$ 2.00

### CHIP CAPACITORS

10( )47( )100( )1000( ) P1	\$ .60
----------------------------	--------

### RF - IF I.C. AMP

MWA-110	
RF—IF AMPLIFIER I.C.	
1 TO 400 MC 14 DB GAIN TYP	
3 TERMINAL IN, OUT, & GROUND	\$ 7.95

### DUAL GATE MOSFET

RCA 40673	\$ 1.50
-----------	---------

### COAX CONNECTORS

BNC CHASSIS MOUNT SQUARE FLANGE	\$ 1.87
BNC PLUG FOR RG—58	\$ 1.87
SMA CHASSIS MOUNT SQUARE FLANGE	\$ 5.90
SMA PLUG FOR RG—58	\$ 6.57
SMA PLUG FOR RG—174	\$ 6.57
TYPE N CHASSIS MOUNT SQUARE FLANGE	\$ 3.20
TYPE N PLUG FOR RG—9/RG—8	\$ 3.69

### FEED-THRU CAPACITORS

500 PF	\$ .50
--------	--------

### TEFLON CIRCUIT BOARD

APPROX. 3.5" x 5.0" x .010	\$ 5.50
APPROX. 3.5" x 5.0" x .0312	\$ 6.50

### CHIP RESISTORS

50 OHM 1/2 WATT	\$ 1.50
-----------------	---------

### PISTON TRIMMERS

Triko 201—01M.5—3PF( )1—8PF( )	\$ 2.50
--------------------------------	---------



**OPEN AT 8PM EST**  
**CLOSED AT 8PM PST**

**IF YOU DO NOT SEE**

**WHAT YOU WANT ASK**

**ORDERS ARE POSTAGE PAID**  
**COD—VISA—MASTERCHARGE**

# NEW FROM GLB

A complete line of **QUALITY 50 thru 450 MHz TRANSMITTER AND RECEIVER KITS.** Only two boards for a complete receiver. 4 pole crystal filter is standard. Use with our **CHAN-NELIZER** or your crystals. Priced from \$69.95. Matching transmitter strips. Easy construction, clean spectrum, **TWO WATTS** output, unsurpassed audio quality and built in **TONE PAD INTERFACE.** Priced from \$29.95.

**SYNTHESIZER KITS** from 50 to 450 MHz. Prices start at \$119.95.

Now available in **KIT FORM** — **GLB Model 200 MINI-SIZER.**

Fits any HT. Only 3.5 mA current drain. Kit price \$159.95 Wired and tested. \$239.95

Send for **FREE 16 page catalog.**

We welcome Mastercharge or VISA

**GLB ELECTRONICS**  
 1952 Clinton St., Buffalo, N. Y. 14206

# Hobbyists:



Here is an interesting general electronics hobby magazine. It's loaded with lots of interesting ideas, not only about simple circuits and radio, but in all phases of electronics including test gear, audio, remote control and security systems. We are sure that you will find a number of worthwhile projects in this British magazine. While projects in this British magazine. For a sample copy, please send \$1 to cover postage and handling costs. Your dollar is applied to the cost of the subscription when ordered.

**1 Year (12 issues) \$20.00**  
**Radio & Electronics Constructor**  
 Greenville, NH 03048

**MICHIGAN:** Five County Swap-N-Shop on September 21 at the Southwestern High School, 1420 W. 12th St., Flint, Michigan. Food, free parking, prizes and more. Tickets: \$2.00 per person advance and \$3.00 at door. More info: Bob Ross, P.O. Box 7671, Flint, Michigan 48507. (313) 239-0397.

**VIRGINIA STATE ARRL CONVENTION:** The Fifth Annual Tidewater Hamfest and ARRL Virginia State Convention will be in the great new Virginia Beach, Virginia Arts and Conference Center, October 4 and 5, 1980. ARRL, Traffic, DX Forums, XYL free bingo and lounge. Admission \$3.50. Advance admission ticket drawing for Kenwood FM transceiver. Flea market spaces \$3.00 day. Ticket and information - TRC, P.O. Box 7101, Portsmouth, Virginia 23707 SASE.

**INDIANA:** Porter County Amateur Radio Club's annual Hamfest at the Porter County Fairgrounds, Valparaiso, Indiana, on September 14. Flea market, door prizes, dealers, plus more. Talk-in on 147.96/36 and 146.52 MHz. Advanced tickets: \$1.50. At gate: \$2.00. More info or tickets: Charles Baker, P.O. Box 251, Portage, Indiana 46368.

**GEORGIA:** Lanierland Amateur Radio Club's HAMNIC at Lake Lanier Islands on September 28th. Large covered pavilion and parking area for Swap Shop and exhibits. Food available. No entry fee for HAMNIC. Lanier Islands charge \$2.50 entry fee per car. Picnic, hiking and swimming for kids. Trailer hook-ups and camping available on site. Many prizes. Talk-in on .07/67. More info: Fred Runkle, 25 Stonehedge Dr., Buford, GA 30518.

**FLORIDA:** 15th annual Hamfest of the Platinum Coast Amateur Radio Society on September 6 and 7 at the Melbourne Civic Center. Swap tables, meetings, forums, and more. For info, swap tables, or reservations: PCARS, P.O. Box 1004, Melbourne, FL 32901.

**PENNSYLVANIA:** Skyview Radio annual Swap and Shop on September 21, 12:00 to 4:00 PM at Sokol Camp, Lower Burrell, Pennsylvania. Registration: \$1.00, XYL's, YL's and children free. More info: Jim Jackson, RD #1, Box 7A, Apollo, PA 15613.

**PENNSYLVANIA QSO PARTY** sponsored by NARC on September 13 and 14. One of the "Granddaddys" of the state contests. For more info: Walt Supina, 525 W. Ridge Ave., State College, Pennsylvania 16801.

**PENNSYLVANIA:** Fort Venango Mike and Key Club will sponsor an expedition to Venus, Pennsylvania, on September 6 and 7. Operations on Novice and General portions of the band. All modes, all bands including 2 meter FM on 147.12-147.72. Operation will be in Clarion county. Certificate available S.A.S.E. required. More info: Joseph Szabat, 228 Plummer St., Oil City, PA 16301.

**NEW YORK:** Elmira Amateur Radio Association's 5th annual International Hamfest at Chemung Co. Fairgrounds on September 27. Starts at 8:00 AM. FCC and ARRL forums, flea market, many door prizes and food available. Dealer displays also. Contact: John Breese, 340 West Ave., Horseheads, New York 14845.

**NEW YORK:** Tu-boro A.R.C.'s auction on September 18 at the Odd Fellows Hall, 149-14 14th Ave., Whitestone, NY. For info call Walt, WB2PFO at (212) 539-5732. Talk-in on 146.52.

**YLRL's HOWDY DAYS** on September 10 at 1800 UTC through September 12 at 1800 UTC. Start the fall season by chatting with old friends and finding new ones. Extend invitation to join YLRL. For more info: lone O'Donnell, WA2DMK, YLRL Vice-President, Newcomb, NY 12852.

**DELTA QSO PARTY** sponsored by the Delta Division of the ARRL on Sept. 27 (from 1800Z) to Sept. 28 (2400Z). No time or power restrictions. Amateurs outside the Delta Division will try and contact as many amateurs inside of the Delta Division (Ark-La-Miss-Tenn) as possible. Delta amateurs try for as many inside and outside Delta Division. For more info: Malcolm P. Keown, W5XX, 213 Moonmist, Vicksburg, MS 39180.

**EX-KZ5 REUNION** for all former KZ5s for 48 hours beginning 0001Z, September 27. Listen within the lowest 25 kHz of the CW and phone segments of the U.S. General Class portion on each band. More info: John B. Barham, PSC Box 4481, APO Miami, FL 34001.

**DXPO '80** on September 27 and 28 at the Ramada Inn, Tysons Corner, Virginia. Sponsored by the National Capital DX Association. DXPO program, Attitude Adjustment Party (with ALC), DXPO International Banquet and prizes. More info: Dick Vincent, Rte. 1 Box 230, Bryantown, MD 20617.

**VIRGINIA:** Lynchburg's Kaleidoscope Festival from September 22-28. CW operation will be 50 kcs up from the bottom of each band and SSB 10 kcs inside the General portion of the phone band. Obtain certificate QSL by sending 28¢ postage or 2 IRC's to K4HEX Manager, 212 Sandown Circle, Lynchburg, VA 24503.

## GEM-QUAD FIBRE-GLASS ANTENNA FOR 10, 15, and 20 METERS

Two Elements \$159.00  
 Extra Elements \$113.00  
 Price is F.O.B. Transcona  
**INCLUDES U.S. Customs Duty**



**KIT COMPLETE WITH**  
 \*SPIDER  
 \*ARMS  
 \*WIRE  
 \*BALUN KIT  
 \*BOOM WHERE NEEDED

WINNER OF MANITOBA DESIGN INSTITUTE AWARD OF EXCELLENCE

*Buy two elements now — a third and fourth may be added later with little effort.*

*Enjoy up to 8 db forward gain on DX, with a 25 db back to front ratio and excellent side discrimination.*

*Get maximum structural strength with low weight, using our "Tridetic" arms. Please inquire directly to:*

**GEM QUAD PRODUCTS LTD.**  
 Box 53  
 Transcona Manitoba  
 Canada R2C 2Z5  
 Tel. (204) 866-3338

## S-LINE OWNERS ENHANCE YOUR INVESTMENT

### TUBESTERS™

Plug-in, solid state tube replacements

- S-line performance—solid state!
- Heat dissipation reduced 60%
- Goodbye hard-to-find tubes
- Unlimited equipment life

TUBESTERS cost less than two tubes, and are guaranteed for so long as you own your S-line.

### SKYTEC

Box 535  
 Talmage, CA 95481

Write or phone for specs and prices.  
 (707) 462-6882

## FACSIMILE

COPY SATELLITE PHOTOS, WEATHER MAPS, PRESS!

The Faxes Are Clear — on our full size (18-1/2" wide) recorders. Free Fax Guide.

## TELETYPE

RTTY MACHINES, PARTS, SUPPLIES

ATLANTIC SURPLUS SALES (212) 372-0349  
 3730 NAUTILUS AVE BROOKLYN NY 11224

**39<sup>95</sup>** ADD \$2.50 FOR POSTAGE

**30 CHANNEL CABLE TV CONVERTER**

**FREE!** UNUSUAL 96 PAGE ELECTRONIC PARTS & IDEAS CATALOG!

ORDER No. 185AE047  
 ENCO ROUTE 9N, PLATTSBURGH, N.Y. 12901  
 Tel. (518) 561-8700.

## RADIO WAREHOUSE

No Frills, Just Low Prices



\$899<sup>95</sup>

TEN-TEC OMNI-D



\$545<sup>95</sup>

KENWOOD TS-520 SE

ICOM IC-255 A \$309<sup>95</sup>  
 HM-8 TOUCHTONE® MIKE \$34<sup>95</sup>



\$199<sup>95</sup> ICOM IC-2A "TALKIES"

Call or Write for Quote  
 All Major Brands

P.O. BOX 2728  
 DALLAS, TX 75201  
 Telephone: (817) 496-9000

# Hungup in Homebrew?

## RADIOKIT Is Back

Operating under new management for all  
your radio parts needs:

- Amphenol connectors
- B&W coils and switches
- Chassis and enclosures
- Coaxial switches
- Jackson dials and drives
- J.W. Miller parts
- Knobs and shaft couplers
- Millen components
- Padders and variable capacitors
- Resistors, capacitors, inductors
- Roller inductors and dials
- Semiconductors
- Toroids, cores and beads
- Wire and cable

**KITS:** Split-Band Speech Processor (hr. 9/79), 40-Meter Transceiver (hr. 4/80), RF Noise Bridge (hr. 2/77), IARU Rx and Tx (QST, 4/78 & 12/78), W1JR Broadband Balun (hr. 9/78), Memory Accu-Keyer (hr. 4/79), and many more.

NEW SEPTEMBER CATALOG  
Send 25 cents

# RADIOKIT

Box 411H, Greenville, NH 03048  
(603) 878-1033

Kantronics Announces

## Gold Label Series Tapes

- Choosing and Using the Best Antenna**  
Find out how a better antenna adds power and versatility to your station. C-60 \$6.95

- Ins and Outs of Running Your Own Ham Station**  
Learn the tricks of operating a station that make ham radio more fun. Set of 2 C-60 Tapes \$11.95

- Sounds of Shortwave**  
Hear examples and explanations of many strange signals you've heard, plus a discussion of antennas and receivers. C-60 \$6.95

- Understanding the Mysterious Ionosphere**  
Learn more about the ionized layers and improve your contacts. C-60 \$6.95

- General Class Q and A Tape**  
Review theory and regulations covered on the General- or Technician-Class exam. C-60 \$6.95

- The New Extra-Class Study Cassette**  
The basics to understand before taking the new Extra-Class exam. C-60 \$6.95

Please add \$1.00 shipping for one tape and \$2.00 shipping for 2 or more tapes.

**Kantronics**  
(913) 842-7745  
1202 E. 23rd Street  
Lawrence, Kansas 66044

**NEW YORK:** Yonkers Amateur Radio Club's annual flea market and Hamfest at Redmond Field in Yonkers, New York, on October 5, rain date: October 12. 9:00 A.M. - 5:00 P.M. Door prizes every hour and a giant final door prize. Giant auction starting at 3:00 P.M. Free parking, refreshments, picnic tables and more. Bring the family. For all Hams, CB'ers, SWL'ers, HI-FI'ers and Comp-Buffs. Admission: \$1.50 per person. Under 12 free. Sellers: \$3.00 per parking space. Talk-in on 146.865/52 simplex. CB'ers, Channel 4 at 8:00 A.M. Advanced registration and more info: (914) 969-1053 (after 3:00). Ask for Otto.

**IOWA:** Cedar Valley Amateur Radio Club's hamfest on October 5th at the Hawkeye Downs Exhibition Hall in Cedar Rapids. Technical talks, large flea market, manufacturers and dealers. Tickets: \$2.00 advance, \$3.00 at door. Write CVARC Hamfest, Box 994, Cedar Rapids, IA 52406.

**ALABAMA:** Calhoun County Amateur Radio Association's hamfest on September 27 and 28 at the Municipal Auditorium, 1128 Gurnee Ave., Anniston, Alabama. 9 AM - 5 PM on Saturday and 9 AM - 3 PM on Sunday. Free admission, parking, bingo, and overnight self-contained RV parking. Over 8,000 sq. ft. air-conditioned exhibit area. Hourly drawings and final drawing on Sunday for great grand prizes. Donations for door prizes: \$1 or 6 for \$5. Talk-in on 69/09. Tables: \$3.00 for one day, \$5.00 for both. Contact: CCARA, P.O. Box 1624, Anniston, AL 36202. (205) 820-3619.

**TEXAS:** Houston Con-Vention 80 on October 3-5 at the Marriott Brookhollow Hotel, Houston, Texas. Commercial exhibitors, technical sessions, DX and contest activities, covered flea market, banquet, transmitter hunt, and much more. Host: Texas DX Society. Banquet speaker: Roy Neal, K6NUE, science editor for NBC news. Special hotel rate of \$30 per day per room (four people) for convention attendees. Plenty of parking. More info: HHC, P.O. Box 79252, Houston, TX 77024.

**LOUISIANA:** New Orleans Hamfest-Computerfest (AMACOM '80) on October 10-12 at the Airport Hilton Inn, Kenner, Louisiana, across the street from the New Orleans International Airport. One of the largest gatherings of electronics hobbyists in the Deep South.

**ILLINOIS:** Sangamon Valley Radio Club's hamfest on September 28th at the Sangamon County Fairgrounds, New Berlin, 12 miles west of Springfield on Rt. 36. Indoor display and covered pavilion. Randy Rowe, N0TG talks on the Navassa DXpedition! Exhibits, kids activities and food available. Overnight camping. First prize: Kenwood TR-2400 H/T. Tickets: \$1.50 advance, \$2.00 gate. Info: Joe Suarez, WB9RRC, S.V.R.C., 1025 S. 6th, Springfield, IL 62703.

**SOUTH CAROLINA:** York County Amateur Radio Society's hamfest on October 5, at Joslin Park in Rock Hill. B-B-Q dinner and snack bar in park. For registration and prize info: Y.C.A.R.S., P.O. Box 414CRS, Rock Hill, SC 29730.

**COLORADO:** Boulder Amateur Radio Club's BARCFEST '80 on September 28th beginning at 9:00 A.M. at the Boulder National Guard Armory on North Broadway at the city limits. Auction, snack bar. \$2.00 admission per family includes door prizes and swap space. Talk-in on 146.1070 and 52/52. More info: Mark Call, N0MC, 4297 Redwood Ct., Boulder, CO 80301. (303) 442-2616.

**GREATER DELAWARE VALLEY — 80 HAMFEST** will be held October 19, 1980, in Pennsauken, New Jersey, at the Nashville East Cotillion Ballroom on Rt. 73 from 8 AM to 5 PM. Over 19,000 square feet of exhibit space (no hallways). Seminars, YL/XYL activities, and films. Door prizes hourly until 3:30. Talk-in 146.22/82. Tailgating is \$3.00/10' space, indoor tables are \$5.00. Tickets are \$2.50 at the gate and \$2.00 in advance. For reservations, maps or tickets write GDV-80, 15 East Camden Avenue, Moorestown, New Jersey 08057 or call 609-234-3926.

**RADIO EXPO "80"** Lake County fair grounds, Rt. 45 & 120. Sept. 6 & 7 — advanced tickets \$2.00, \$3.00 at gate. Write: Radio Expo Tickets, P.O. Box 1532, Evanston, IL 60204. Exhibitor information call (312) BST-EXPO.

**MICHIGAN:** Adrian Amateur Radio Club's 8th annual Hamfest on September 28 at the Lenawee County Fairgrounds, Adrian, Michigan. Tickets, tables, info: Adrian Amateur Radio Club, Inc., P.O. Box 26, Adrian, Michigan 49221.

**FINDLAY HAMFEST:** The 38th Annual Findlay Hamfest greets you on Sept. 7th with a fine new indoor/outdoor location, The Hancock Recreational Center, just east of I-75 exit 161, on the north edge of Findlay, 40 miles south of Toledo. Main Prizes: a TS-120s W/supply, two TR-2400's, and an AT-120 matcher. Tickets \$2.00 advance and \$2.50 at the door. Reserve your tables early: \$2.50 per 1/2. Open Saturday 17:00 till 22:00 for forums and set-up, Sunday at 05:00. Join the over 6000 people attending Findlay Hamfest this year and spend your bucks on the best! For tickets, info, and reservations send S.A.S.E. to P.O. Box 587, Findlay, Ohio 45840.

## OCTOBER Features in

# hr

- Voice Band Equalizer
- 40 M Quad
- Transmission Lines
- Antenna Radials
- And More!

Don't miss the exciting October issue. Available soon in your local radio store. Not there? Then subscribe today. Just \$15 for 12 big issues.

**HAM RADIO**  
GREENVILLE, NH 03048

## MINIATURE AUTOMATIC MORSE CODE RADIO STATION IDENTIFIER MODEL — 97813



**REDUCED 40%, NOW \$59.95**

- COMPLIES WITH NEW FCC RULES, PARTS 89, 91, 93, 95
- **MULTI-MODE OPERATION:** MANUAL, SEMI-AUTO AND AUTO.
  - MANUAL MODE** — A pushbutton switch triggers the identifier which keys the transmitter for the duration of the ID cycle.
  - SEMI-AUTO MODE** — The PTT line activates the ID'er if the repeat interval time has elapsed and keeps the transmitter keyed throughout the duration of the ID cycle.
  - AUTO MODE** — The identifier will key the transmitter and ID every time the repeat interval time has elapsed.
- **CONNECTS DIRECTLY TO MICROPHONE AND PTT INPUTS OF MOST TRANSMITTERS. MINIATURE SIZE MAKES IT FEASIBLE TO MOUNT INSIDE THE TRANSMITTER.**
- **PROGRAMMABLE CODE SPEED, TONE, AND REPEAT TIME.**
- **ADJUSTABLE CODE AUDIO LEVEL.**
- **PREPROGRAMMED MEMORY ELEMENTS** — 254 OR (510 BIT) (OPTIONAL)
- **SIZE** — 1 X 4 INCHES
- **INCLUDES SWITCHES, WIRING AND INSTRUCTION MANUAL.**

**MODEL 97813** — NOW ONLY \$59.95 assembled & tested  
**MODEL 11765** — Beacon CW ID'er with programmable code speed • great for 1750 meter band • 254 bit memory; 510 bit optional • 1.3 x 2.0 PCB • LIST PRICE \$24.95/kit; \$34.95/assembly

All orders must be prepaid or C.O.D. allow four weeks delivery. C.A. res. add sales tax. Additional preprogrammed memory elements available. Include \$3.00 shpg/hdng on all orders. One year warranty.

**Securtron Co.**  
P.O. Box 32145 • San Jose, Ca. 95152  
Phone (408) 294-8383



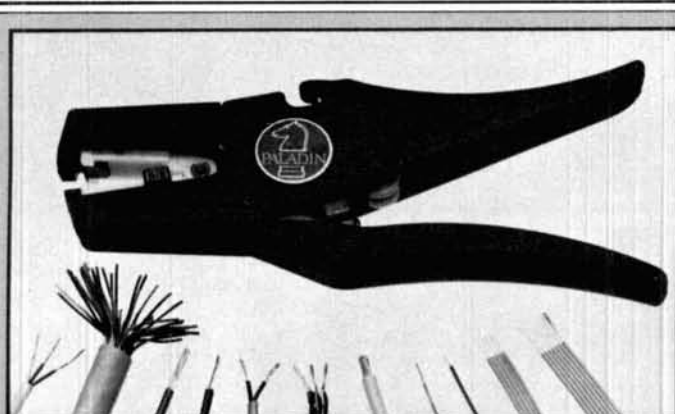

## INTRODUCING ONE STEP STRIPPING

Now all wire stripping from 12 to 30 AWG can be done in one step, with one tool! No need for two or more tools to handle different size wires... THE STRIPPER'S built-in sensor automatically adjusts to cut and strip solid or stranded wire and multiple cable. And the built-in cutter eliminates the need for still another inconvenient, space-consuming tool. THE STRIPPER feeds from the front, so it can reach anywhere... even into the tightest places. Stainless steel, self-adjusting stripping blades are industrially tough... up to 100,000 strips or more. This convenient pocket-size tool is strong enough to cut and strip as many as six conductors simultaneously in bonded or molded cables! The fiberglass, reinforced nylon body is virtually indestructible and electrically insulated from any shock hazards. Higher productivity... eliminates nicked wires... dependable quality... and the convenience of one-step stripping. Satisfaction guaranteed.

### ORDER FORM

Name \_\_\_\_\_  
 Address \_\_\_\_\_  
 City \_\_\_\_\_ State \_\_\_\_\_ Zip \_\_\_\_\_  
 M/C-VISA # \_\_\_\_\_ Exp. Date \_\_\_\_\_

Please send me (qty) \_\_\_\_\_  
 Paladin Stripex #PA1100 at \$37.95 ea.  
 Plus \$2.00 shipping and handling  
 Check, money order or Master Charge/Visa  
 Calif. Res. Add 6% Tax

**DESIGN MARKETING**  
 5892 Fasley Street  
 Dept. H.R.  
 Simi, California 93063  
 Phone (805) 581-2181

Factory Direct Only!

## THE WORLDS FIRST

1800 CHANNEL FULLY SYNTHESIZED  
 COMPACT VHF FM MONITOR

**AR-22**  
 FACTORY DIRECT  
 PRICE \$125.00

This price in U.S. only



■ **FULL BAND COVERAGE**  
 141.000-149.995 MHZ  
 5 KHZ Steps by digital switches.

■ **SLIM SIZE AND LIGHT-WEIGHT.**  
 5¼"(H) x 2½"(W) x 1"(D)  
 7.1 oz with NiCd Battery Pack



■ **COMMERCIAL BAND TYPE (151-159 MHZ) IS ALSO AVAILABLE.**

■ **CREDIT CARDS/MONEY ORDER OR ANY COMMERCIAL GUARANTEED CHECK...U.P.S. COD**

**ACE COMMUNICATIONS, INC.**

2832-D Walnut Avenue, Tustin, California 92680  
 Phone (714)544-8281

**JAN CRYSTALS**  
**HOLD THE FREQUENCY**

- CB
- CB standard
- 2 meter
- Scanners
- Amateur Bands
- General Communication
- Industry
- Marine VHF
- Micro processor crystals

Send 10¢ for our latest catalog. Write or phone for more details.

**JAN CRYSTALS** easy to charge

2400 Crystal Drive  
 Ft. Myers, Florida 33907  
 all phones (813) 936-2397

## ASTRON POWER SUPPLIES

• HEAVY DUTY • HIGH QUALITY • RUGGED • RELIABLE •

### SPECIAL FEATURES

- SOLID STATE ELECTRONICALLY REGULATED
- FOLD-BACK CURRENT LIMITING Protects Power Supply from excessive current & continuous shorted output.
- CROWBAR OVER VOLTAGE PROTECTION on Models RS-7A, RS-12A, RS-20A, RS-35A, RS-20M & RS-35M
- MAINTAIN REGULATION & LOW RIPPLE at low line input Voltage.
- HEAVY DUTY HEAT SINK • CHASSIS MOUNT FUSE
- THREE CONDUCTOR POWER CORD
- ONE YEAR WARRANTY • MADE IN U.S.A.
- VOLT & AMP METER ON MODELS RS-20M & RS-35M

### PERFORMANCE SPECIFICATIONS

- INPUT VOLTAGE: 105 - 125 VAC
- OUTPUT VOLTAGE: 13.8 VDC ±0.05 volts (Internally Adjustable: 11-15 VDC)
- RIPPLE: Less than 5mv peak to peak (full load & low line)
- REGULATION: ±.05 volts no load to full load & low line to high line



**ASTRON 20 AMP REGULATED POWER SUPPLY Model RS-20M**  
 16 Amps continuous  
 20 Amps ICS\*  
 5" (H) x 9" (W) x 10.5" (D)  
 Shipping Weight 20 lbs.  
 Price ..... \$117.95

Other popular POWER SUPPLIES also available: (Same features and specifications as above)

Model	Continuous Duty (amps)	ICS* (amps)	Size (in.) H X W X D	Shipping Wt. (lbs.)	Price
RS-35M	25	35	5 X 11 X 11	29	\$167.95
RS-35A	25	35	5 X 11 X 11	29	\$149.95
RS-20A	16	20	5 X 9 X 10½	20	\$99.95
RS-12A	9	12	4½ X 8 X 9	13	\$74.95
RS-7A	5	7	3¼ X 6½ X 9	8	\$54.95
RS-4A	3	4	3¼ X 6½ X 9	5	\$39.95

\*ICS — Intermittent Communication Service (50% Duty Cycle)  
 If not available at your local dealer, please contact us directly.

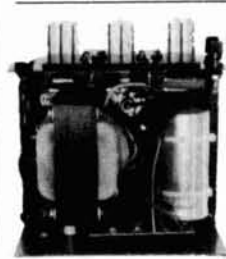

Inside View — RS-12A

**ASTRON CORPORATION**

1971 South Ritchey Street  
 Santa Ana, CA 92705  
 (714) 835-0682



# Ham Radio's guide to help you find your local

## Arizona

### POWER COMMUNICATIONS CORPORATION

6012 N. 27TH AVE.  
PHOENIX, AZ 85017  
602-242-6030 or 242-8990  
Arizona's #1 "Ham" Store. Yaesu, Kenwood, Icom and more.

## California

### C & A ELECTRONIC ENTERPRISES

2210 S. WILMINGTON AVE.  
SUITE 105  
CARSON, CA 90745  
213-834-5868  
Not The Biggest, But The Best —  
Since 1962.

### JUN'S ELECTRONICS

11656 W. PICO BLVD.  
LOS ANGELES, CA 90064  
213-477-1824 Trades  
714-463-1886 San Diego  
The Home of the One Year Warranty  
— Parts at Cost — Full Service.

### QUEMENT ELECTRONICS

1000 SO. BASCOM AVENUE  
SAN JOSE, CA 95128  
408-998-5900  
Serving the world's Radio  
Amateurs since 1933.

### SHAVER RADIO, INC.

1378 S. BASCOM AVENUE  
SAN JOSE, CA 95128  
408-998-1103  
Atlas, Kenwood, Yaesu, KDK,  
Icom, Tempo, Wilson, Ten-Tec,  
VHF Engineering.

## Connecticut

### HATRY ELECTRONICS

500 LEDYARD ST. (SOUTH)  
HARTFORD, CT 06114  
203-527-1881  
Connecticut's Oldest Ham  
Radio Dealer.

### THOMAS COMMUNICATIONS

95 KITTS LANE  
NEWINGTON, CT 06111  
203-667-0811  
Authorized dealer for Kenwood,  
Yaesu, Drake, Icom, etc. - CALL US!

## Delaware

### DELAWARE AMATEUR SUPPLY

71 MEADOW ROAD  
NEW CASTLE, DE 19720  
302-328-7728  
ICOM, Ten-Tec, Swan, DenTron,  
Tempo, Yaesu, Azden, and more.  
One mile off I-95, no sales tax.

## Florida

### AGL ELECTRONICS, INC.

1898 DREW STREET  
CLEARWATER, FL 33515  
813-461-HAMS  
West Coast's only full service  
Amateur Radio Store.

### AMATEUR RADIO CENTER, INC.

2805 N.E. 2ND AVENUE  
MIAMI, FL 33137  
305-573-8383  
The place for great dependable  
names in Ham Radio.

### RAY'S AMATEUR RADIO

1590 US HIGHWAY 19 SO.  
CLEARWATER, FL 33516  
813-535-1416  
Atlas, B&W, Bird, Cushcraft,  
DenTron, Drake, Hustler, Hy-Gain,  
Icom, K.D.K., Kenwood, MFJ, Rohn,  
Swan, Ten-Tec, Wilson.

## Illinois

### AUREUS ELECTRONICS, INC.

1415 N. EAGLE STREET  
NAPERVILLE, IL 60540  
312-420-8629  
"Amateur Excellence"

### ERICKSON COMMUNICATIONS, INC.

5456 N. MILWAUKEE AVE.  
CHICAGO, IL 60630  
Chicago - 312-631-5181  
Outside Illinois - 800-621-5802  
Hours: 9:30-5:30 Mon, Tu, Wed &  
Fri.; 9:30-9:00 Thurs; 9:00-3:00 Sat.

## Kansas

### ASSOCIATED RADIO

8012 CONSER, P. O. BOX 4327  
OVERLAND PARK, KS 66204  
913-381-5900  
America's No. 1 Real Amateur  
Radio Store. Trade - Sell - Buy.

## Maryland

### THE COMM CENTER, INC.

LAUREL PLAZA, RT. 198  
LAUREL, MD 20810  
800-638-4486  
Kenwood, Drake, Icom, Ten-Tec,  
Tempo, DenTron, Swan  
& Apple Computers.

## Massachusetts

### TEL-COM, INC.

675 GREAT ROAD, RT. 119  
LITTLETON, MA 01460  
617-486-3040  
The Ham Store of New England  
You Can Rely On.

### TUFTS RADIO ELECTRONICS

206 MYSTIC AVENUE  
MEDFORD, MA 02155  
617-391-3200  
New England's friendliest  
ham store.

## Minnesota

### PAL ELECTRONICS INC.

3452 FREMONT AVE. NO.  
MINNEAPOLIS, MN 55412  
612-521-4662  
Midwest's Fastest Growing Ham  
Store, Where Service Counts.

## New Hampshire

### EVANS RADIO, INC.

BOX 893, RT. 3A BOW JUNCTION  
CONCORD, NH 03301  
603-224-9961  
Icom, DenTron & Yaesu dealer.  
We service what we sell.

**Dealers:** YOU SHOULD BE HERE TOO!  
Contact Ham Radio now for complete details.

## Amateur Radio Dealer

### New Jersey

**RADIOS UNLIMITED**  
P. O. BOX 347  
1760 EASTON AVENUE  
SOMERSET, NJ 08873  
201-469-4599  
New Jersey's Fastest Growing  
Amateur Radio Center.

**ROUTE ELECTRONICS 46**  
225 ROUTE 46 WEST  
TOTOWA, NJ 07512  
201-256-8555  
Drake, Swan, DenTron, Hy-Gain,  
Cushcraft, Hustler, Larsen, Etc.

**WITTIE ELECTRONICS**  
384 LAKEVIEW AVENUE  
CLIFTON, NJ 07011  
(201) 546-3000  
Same location for 63 years.  
Full-line authorized Drake dealer.  
We stock most popular brands of  
Antennas and Towers.

### New Mexico

**PECOS VALLEY  
AMATEUR RADIO SUPPLY**  
112 W. FIRST STREET  
ROSWELL, NM 88201  
505-623-7388  
Now stocking Ten-Tec, Lunar, Icom,  
Morsematic, Bencher, Tempo,  
Hy-Gain, Avanti and more at low,  
low prices. Call for quote.

### New York

**GRAND CENTRAL RADIO**  
124 EAST 44 STREET  
NEW YORK, NY 10017  
212-599-2630  
Drake, Kenwood, Yaesu, Atlas,  
Ten-Tec, Midland, DenTron,  
Hy-Gain, Mosley in stock.

**HARRISON RADIO CORP.**  
20 SMITH STREET  
FARMINGDALE, NY 11735  
516-293-7990  
"Ham Headquarters USA"  
since 1925.  
Call toll free 800-645-9187.

**RADIO WORLD**  
ONEIDA COUNTY AIRPORT  
TERMINAL BLDG.  
ORISKANY, NY 13424  
Toll Free 800-448-7914  
NY { 315-337-2622  
Res. { 315-337-0203  
New & Used Ham Equipment.  
See Warren K2IXN or Bob WA2MSH.

### Ohio

**UNIVERSAL AMATEUR RADIO, INC.**  
1280 AIDA DRIVE  
COLUMBUS (REYNOLDSBURG)  
OH 43068  
614-866-4267  
Complete Amateur Radio Sales and  
Service. All major brands - spacious  
store near I-270.

### Pennsylvania

**HAMTRONICS, DIV. OF  
TREVOSE ELECTRONICS**  
4033 BROWNSVILLE ROAD  
TREVOSE, PA 19047  
215-357-1400  
Same Location for 30 Years.

**LaRUE ELECTRONICS**  
1112 GRANDVIEW STREET  
SCRANTON, PENNSYLVANIA 18509  
717-343-2124  
ICOM, Bird, Cushcraft, CDE,  
Ham-Keys, VHF Engineering,  
Antenna Specialists.

**SPECIALTY COMMUNICATIONS**  
2523 PEACH STREET  
ERIE, PA 16502  
814-455-7674  
Service, Parts, & Experience  
For Your Atlas Radio.

### Virginia

**ELECTRONIC EQUIPMENT BANK**  
516 MILL ST., N.E.  
VIENNA, VA 22180  
703-938-3350  
Metropolitan D.C.'s One Stop  
Amateur Store. Largest  
Warehousing of Surplus Electronics.

TELL YOUR FRIENDS  
about

**ham  
radio**

1 year  
subscription **\$15.00**  
US ONLY

**HAM RADIO MAGAZINE**  
GREENVILLE, NH 03048

# CALL TOLL FREE

For the best deal on

- AEA • Alliance • Ameco • Apple • ASP
- Avanti • Belden • Bencher • Bird • CDE
- CES • Communications Specialists
- Collins • Cushcraft • Daiwa • DenTron
- Drake • Hustler • Hy-Gain • Icom • IRL • KLM
- Kenwood • Larsen • Macrotronics • MFJ
- Midland • Mini-Products • Mirage • Mosley
- NPC • Newtronics • Nye • Panasonic
- Palomar Engineers • Regency • Robot
- Shure • Standard • Swan • Tempo
- Ten-Tec • Transcom • Yaesu

Icom IC-255A ... call for  
**BANG-UP July 4 price!**

Kenwood TR-2400 .. in  
stock, delivery **NOW!**  
FT-227RA closeout...  
only **\$299!**

Apple II (or plus) .. **\$999**  
with 48k ..... **\$1199**

Macrotronics RTTY/CW  
software and system for  
Apple ... Now in stock

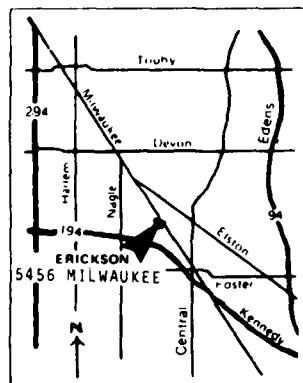

**CALL TOLL FREE**  
(outside Illinois only)

**(800) 621-5802**



Hours:

9:30-5:30 Mon., Tues., Wed. & Fri.  
9:30-9:00 Thursday  
9:00-3:00 Saturday

**ERICKSON**  
COMMUNICATIONS INC

5456 N. MILWAUKEE AVE

CHICAGO, IL 60630 (312) 631-5181

## WE HAVE A NEW NUMBER FOR YOU

ALL 3 CIRCUITS ARE .180" IN THICKNESS

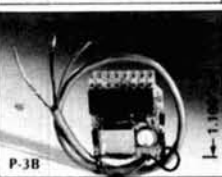
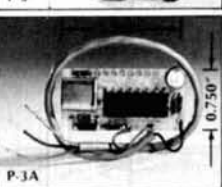
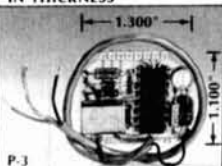

**P-3** The P-3 SERIES is a Quality PIPO COMMUNICATIONS Touch-Tone® Encoder consisting of a separate keyboard and 3 different circuit board arrangements to choose from. P-3, P-3A, and P-3B . . . . . \* The P-3 SERIES offers a variety of installation possibilities for the custom builder and the O.E.M. . . . . \*

### FEATURES:

Wide Voltage Range • Immune to RFI • Gold Contacts • Not a Kit . . . . . \* Temperature Range - 15°F to +160°F.

12 Key . . . . . \$39.00  
16 Key . . . . . \$43.00  
16 Key Slim . . . . . \$48.00  
(Tempo-S1, Wilson MK IV)

### DEALERS:

LOS ANGELES: HENRY RADIO (800) 421-6631  
DENVER: CW ELECTRONICS (303) 832-1111  
ST. LOUIS, MO: HAM RADIO CENTER (800) 325-3636  
VIENNA, VA: ELEC. EQUIPMENT BANK (703) 938-3350

\* For Complete Information And Dealers List Write to:

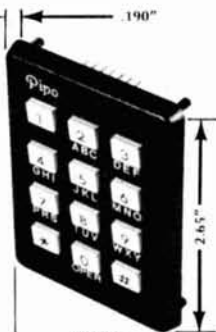

PATENTED

® A.T.&T.

Mail Order To

# Pipo Communications

Emphasis is on Quality & Reliability

P.O. Box 3435  
Hollywood, California 90028  
213/852-1515

For **FREE** book flyer write —  
**HAM RADIO'S BOOKSTORE**  
GREENVILLE, NH 03048

## Comments . . . on HORIZONS

*"refreshing change"*

*"dedicated people who are really making an effort"*

*"better and better every month"*

Want to see what they're talking about?

Subscribe to **HORIZONS** today

12 issues \$12

**HAM RADIO HORIZONS**

GREENVILLE  
NH  
03048

## Microcraft's New Morse-A-Word

Eight character moving display.  
Built-in code practice oscillator.  
Excellent for learning Morse Code.  
Complete — no CRT or expensive extras needed.  
Decodes audio CW signals from your receiver's speaker and displays letters, numbers, punctuation and special Morse characters as the code is received.



MORSE-A-WORD Kit with 4 character readout . . . . . MAWK-4 \$149.95  
MORSE-A-WORD Kit with 8 character readout . . . . . MAWK-8 \$169.95  
MORSE-A-WORD wired & tested with 8 character readout . . . MAWF \$249.95

Send check or money order. Use your VISA or Master Charge. Add \$3.50 shipping and handling for continental U.S. Wisconsin residents add 4% State Sales Tax.

*Microcraft*

Corporation Telephone: (414) 241-8144  
P. O. Box 513HR, Thiensville, Wisconsin 53092

## ALL BAND TRAP ANTENNAS!

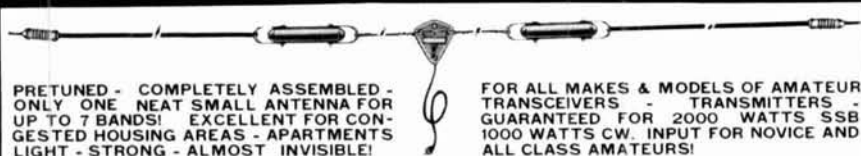

PRE-TUNED - COMPLETELY ASSEMBLED - ONLY ONE NEAT SMALL ANTENNA FOR UP TO 7 BANDS! EXCELLENT FOR CONGESTED HOUSING AREAS - APARTMENTS LIGHT - STRONG - ALMOST INVISIBLE!

FOR ALL MAKES & MODELS OF AMATEUR TRANSCEIVERS - TRANSMITTERS - GUARANTEED FOR 2000 WATTS SSB 1000 WATTS CW. INPUT FOR NOVICE AND ALL CLASS AMATEURS!

COMPLETE AS SHOWN with 90 ft. RG58U-52 ohm feedline, and PL259 connector, insulators, 30 ft. 300 lb. test dacron end supports, center connector with built in lightning arrester and static discharge - molded, sealed, weatherproof, resonant traps 1"X6" - you just switch to band desired for excellent worldwide operation - transmitting and receiving! Low SWR over all bands including 80/75-Tuners usually NOT NEEDED! Can be used as inverted V's - slopers - in attics, on building tops or narrow lots - on 160 meters too! (Instructions incl.) The ONLY ANTENNA YOU WILL EVER NEED FOR ALL BANDS - WITH ANY TRANSCEIVER - NEW - EXCLUSIVE!

80-40-20-15-10-6 Meter --- 104 ft. long - with 90 ft. of RG58U - connector - Model 998BU . . . \$69.95

SEND FULL PRICE FOR POSTPAID INSURED. DEL. IN USA. (Canada is \$5.00 extra for postage - clerical-customs etc.) or order using VISA - MASTER CHARGE - CARD - AMER. EXPRESS. Give number and exp. date. Ph 1-308-236-5333 9AM - 6PM week days. We ship in 2-3 days. ALL PRICES WILL INCREASE . . . SAVE - ORDER NOW! All antennas guaranteed for 1 year. 10 day money back trial if returned in new condition! Made in USA. FREE INFO. AVAILABLE ONLY FROM

WESTERN ELECTRONICS Dept. AR-9 Kearney, Nebraska, 68847

## STUDY AIDS

### KANTRONICS THEORY CASSETTE

Here's a new, easy way to study theory for your Novice, General, Advanced or Extra class exam. Designed for folks on the run. All you have to do is drop in the cassette at home, work, or in the car and listen to an interview-style tape covering Novice, General, Advanced or Extra class theory. A great way to reinforce other study methods.

- KT-NT One tape \$4.95  
Novice Class Theory Cassette
- KT-GT Two tapes \$8.95  
General Class Theory Cassette
- KT-AT One tape \$4.95  
Advanced Class Theory Cassette
- KT-ET One tape \$4.95  
Extra Class Theory Cassette

Please add \$1.00 to cover postage and handling.

Available from  
**HAM RADIO'S BOOKSTORE**  
GREENVILLE, NH 03048

# STOP RF SPILLOVER!

You may be losing up to half the available output from your vertical gain antenna because of RF spillover. The amazing AEA Isopole with unique decoupling design, virtually eliminates RF spillover and can help you multiply your power in all directions on the horizon relative to an ideal half-wave dipole, or end-fed non-decoupled "gain" antennas.

## Get the Facts.

We'll send you a design for an RF spillover tester and a copy of our booklet: *Facts about Proper VHF Vertical Antenna Design* simply for contacting Advanced Electronic Applications, Inc., P.O. Box 2160, Lynnwood, WA 98036. Call 206/775-7373.

## AEA Brings you the Breakthrough!

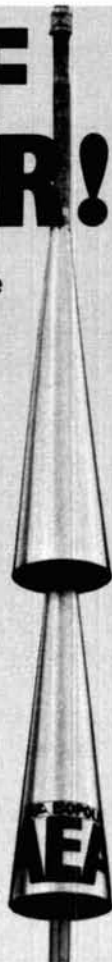

## WANTED FOR CASH

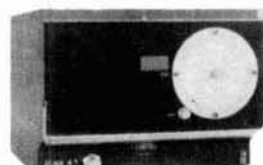

**490-T Ant. Tuning Unit**  
(Also known as CU1658 and CU1669)



**618-T Transceiver**  
(Also known as MRC95, ARC94, ARC102, or VC102)

4CX150  
4CX250  
4CX300A  
4CX350A



4CX1000  
4CX1500  
4CX3000  
4CX5000

4CX10,000    4-65    4-250    4-1000  
5CX1500    4-125A    4-400    304TL

Other tubes and Klystrons also wanted.

Highest price paid for these units. Parts purchased. Phone **Ted, W2KUW** collect. We will trade for new amateur gear. GRC106, ARC105, ARC112, ARC114, ARC115, ARC116, and some aircraft units also required.

## DCO, INC.

10 Schuyler Avenue  
Call Toll Free  
**800-526-1270**

No. Arlington, N. J. 07032  
(201) 998-4246  
Evenings (201) 998-6475

More Details? CHECK—OFF Page 94

## FALL FAVORITES



**NEW!** 11CO5 1 GHz, pre.

ATF 417 pre-amp. net

MRF 901 UHF transistor, 1 GHz

**Special \$59.95**

**Special \$19.95**

**Special \$3.95**

**COMPLETE KITS:** CONSISTING OF EVERY ESSENTIAL PART NEEDED TO MAKE YOUR COUNTER COMPLETE. **HAL-600A** 7-DIGIT COUNTER WITH FREQUENCY RANGE OF ZERO TO 600 MHz. FEATURES TWO INPUTS, ONE FOR LOW FREQUENCY AND ONE FOR HIGH FREQUENCY. AUTOMATIC ZERO SUPPRESSION. TIME BASE IS 1.0 SEC OR .1 SEC GATE WITH OPTIONAL 10 SEC GATE AVAILABLE. ACCURACY ± .001%. UTILIZES 10-MHz CRYSTAL 5 PPM. **COMPLETE KIT \$129**

**HAL-300A** 7-DIGIT COUNTER (SIMILAR TO 600A) WITH FREQUENCY RANGE OF 0-300 MHz. **COMPLETE KIT \$109**

**HAL-50A** 8-DIGIT COUNTER WITH FREQUENCY RANGE OF ZERO TO 50 MHz OR BETTER. AUTOMATIC DECIMAL POINT. ZERO SUPPRESSION UPON DEMAND. FEATURES TWO INPUTS, ONE FOR LOW FREQUENCY INPUT, AND ONE ON PANEL FOR USE WITH AN INTERNALLY MOUNTED HALTRONIX PRE-SCALER FOR WHICH PROVISIONS HAVE ALREADY BEEN MADE. 1.0 SEC AND .1 SEC TIME GATES. ACCURACY ± .001%. UTILIZES 10-MHz CRYSTAL 5 PPM. **COMPLETE KIT \$109**

**FREE:** HAL-79 CLOCK KIT PLUS AN INLINE RF PROBE WITH PURCHASE OF ANY FREQUENCY COUNTER.

### PRE-SCALER KITS

**HAL 300 PRE** ..... (Pre-drilled G-10 board and all components) ..... **\$14.95**

**HAL 300 A/PRE** ..... (Same as above but with preamp) ..... **\$24.95**

**HAL 600 PRE** ..... (Pre-drilled G-10 board and all components) ..... **\$29.95**

**HAL 600 A/PRE** ..... (Same as above but with preamp) ..... **\$39.95**



**HAL-1 GHz PRESCALER**, VHF & UHF INPUT & OUTPUT, DIVIDES BY 1000. OPERATES ON A SINGLE 5 VOLT SUPPLY. **PREBUILT & TESTED \$79.95**

### TOUCH TONE DECODER KIT

HIGHLY STABLE DECODER KIT. COMES WITH 2 SIDED, PLATED THRU AND SOLDER FLOWED G-10 PC BOARD, 7-567's, 2-7402, AND ALL ELECTRONIC COMPONENTS. BOARD MEASURES 3-1/2 x 5-1/2 INCHES. HAS 12 LINES OUT. ONLY **\$39.95**

**DELUXE 12-BUTTON TOUCHTONE ENCODER KIT** UTILIZING THE NEW ICM 7206 CHIP. PROVIDES BOTH VISUAL AND AUDIO INDICATIONS! COMES WITH ITS OWN TWO-TONE ANODIZED ALUMINUM CABINET. MEASURES ONLY 2-3/4" x 3-3/4". COMPLETE WITH TOUCH-TONE PAD, BOARD, CRYSTAL, CHIP AND ALL NECESSARY COMPONENTS TO FINISH THE KIT. **PRICED AT \$29.95**

FOR THOSE WHO WISH TO MOUNT THE ENCODER IN A HAND-HELD UNIT, THE PC BOARD MEASURES ONLY 9/16" x 1-3/4". THIS PARTIAL KIT WITH PC BOARD, CRYSTAL, CHIP AND COMPONENTS. **PRICED AT \$14.95**

**ACCUKEYER (KIT)** THIS ACCUKEYER IS A REVISED VERSION OF THE VERY POPULAR WB4VVF ACCUKEYER ORIGINALLY DESCRIBED BY JAMES GARRETT, IN QST MAGAZINE AND THE 1975 RADIO AMATEUR'S HANDBOOK. **\$18.95**

**ACCUKEYER — MEMORY OPTION KIT** PROVIDES A SIMPLE, LOW COST METHOD OF ADDING MEMORY CAPABILITY TO THE WB4VVF ACCUKEYER. WHILE DESIGNED FOR DIRECT ATTACHMENT TO THE ABOVE ACCUKEYER, IT CAN ALSO BE ATTACHED TO ANY STANDARD ACCUKEYER BOARD WITH LITTLE DIFFICULTY. **\$16.95**

### PRE-AMPLIFIER

**HAL-PA-19 WIDE BAND PRE-AMPLIFIER**, 2-200 MHz BANDWIDTH (-3dB POINTS), 19 dB GAIN. **FULLY ASSEMBLED AND TESTED \$8.95**



**CLOCK KIT — HAL 79 FOUR-DIGIT SPECIAL — \$7.95.** OPERATES ON 12-VOLT AC (NOT SUPPLIED). PROVISIONS FOR DC AND ALARM OPERATION

### 6-DIGIT CLOCK • 12/24 HOUR

COMPLETE KIT CONSISTING OF 2 PC G-10 PRE-DRILLED PC BOARDS, 1 CLOCK CHIP, 6 FND COMM. CATH. READOUTS, 13 TRANS., 3 CAPS, 9 RESISTORS, 5 DIODES, 3 PUSH-BUTTON SWITCHES, POWER TRANSFORMER AND INSTRUCTIONS. DON'T BE FOOLED BY PARTIAL KITS WHERE YOU HAVE TO BUY EVERYTHING EXTRA. **PRICED AT \$12.95**

**CLOCK CASE** AVAILABLE AND WILL FIT ANY ONE OF THE ABOVE CLOCKS. REGULAR PRICE... \$6.50 BUT ONLY **\$4.50 WHEN BOUGHT WITH CLOCK.**

**SIX-DIGIT ALARM CLOCK KIT** FOR HOME, CAMPER, RV, OR FIELD-DAY USE. OPERATES ON 12-VOLT AC OR DC, AND HAS ITS OWN 60-Hz TIME BASE ON THE BOARD. COMPLETE WITH ALL ELECTRONIC COMPONENTS AND TWO-PIECE, PRE-DRILLED PC BOARDS. BOARD SIZE 4" x 3". COMPLETE WITH SPEAKER AND SWITCHES. IF OPERATED ON DC, THERE IS NOTHING MORE TO BUY. **PRICED AT \$16.95**

\*TWELVE-VOLT AC LINE CORD FOR THOSE WHO WISH TO OPERATE THE CLOCK FROM 110-VOLT AC. **\$2.50**

**SHIPPING INFORMATION —** ORDERS OVER \$15.00 WILL BE SHIPPED POSTPAID EXCEPT ON ITEMS WHERE ADDITIONAL CHARGES ARE REQUESTED. ON ORDERS LESS THAN \$15.00 PLEASE INCLUDE ADDITIONAL \$1.00 FOR HANDLING AND MAILING CHARGES. SEND SASE FOR FREE FLYER.



NOW AN ALUMA TOWER DISTRIBUTOR



"HAL"  
HAROLD C. NOWLAND  
W8ZXH

**HAL-TRONIX**  
P. O. BOX 1101  
SOUTHGATE, MICH. 48195  
PHONE (313) 285-1782

## WORLD TIME CALCULATOR **NEW!**

Here's a very handy operating aid for your ham shack. To use it, you locate your local time, move the dial to your local time zone and voila — you know the time anywhere around the world. Besides determining time, you get a full explanation of many confusing terms such as mean solar time, ephemeris time, atomic time, and more. Indispensable aid for both the contest and DX'er. ©1980.

VG-TC

\$2.95



# SAVE TIME & MONEY!

## Shop By Mail

### RADIO FREQUENCY INTERFERENCE

by ARRL

Finally! A new book that helps you understand RFI. Here's a convenient, practical source that details everything from good neighbor relations to simple technical cures for RFI. Six complete chapters take you from RFI definition to good workable solutions. The final section is an FCC reprint that presents a step-by-step procedure to identify, localize, and resolve specific radio-TV interference problems. 64 pages. ©1978.

AR-FI

Softbound \$3.00

### OWNER REPAIR OF RADIO EQUIPMENT

by Frank Glass, K6RQ

"The successful repair of any device results in restoring its operation at least to the level it had just before it quit." With this basic concept in mind, author Frank Glass gives you step by step instructions on how to repair all kinds of electronic equipment. Fourteen chapters cover every aspect of repair procedure from component use and failure and how to read schematic diagrams to a most important subject, safety. This book is a must for the amateur new to servicing his own equipment. 85 pages. ©1979.

RQ-OR

Softbound \$7.95

### 1980 34th EDITION WORLD RADIO & TV HANDBOOK

The world's only complete reference guide to international radio and television. This 1980 edition has complete information on each station including address, frequency and scheduling. Much additional information such as solar activity and World Time Table is included. Unquestionably the leading book of this type. 554 pages. ©1980.

WR-TV

Softbound \$14.95

### THE ARRL ANTENNA ANTHOLOGY

by the ARRL staff

This brand new book pulls together a wide selection of antenna articles from QST. Written for Amateurs of all levels and interests. Included are phased arrays, verticals, Yagi's, ... even the VHF Quagi! Detailed instructions and full illustrations make this a really useful book for any Amateur. 152 pages. ©1979.

AR-AA

Softbound \$4.00

### FM and REPEATERS for THE RADIO AMATEUR

by the ARRL staff

This completely new and updated edition gives you the latest in FM technology and design theory. Highlights include microprocessor control circuitry, and a Phase Lock Loop 2 meter transceiver. This mobile operator's favorite now has more to offer. If you're into FM and repeaters or just want to learn more, we have the book you're looking for. 176 pages. ©1978.

AR-FM

Softbound \$5.00

### ARRL CODE KIT

A good practice kit for upgrading your Novice or Technician license. Two 60 minute cassettes with 30 minutes each at speeds of 5, 7-1/2, 10 and 13 wpm. Also you'll receive an instruction booklet containing hints and suggestions on methods for mastering code.

AR-CK

\$8.00

### RADIOS THAT WORK FOR FREE

by K. F. Edwards

It's not often that you can get something for nothing in this world, but this book will tell you how to come as close to it as possible. "Radios that Work for Free" tells you how to build several circuits, each of which will provide you with music, news and entertainment while using only the intercepted power of the station itself! The parts used are inexpensive, or if you are a good scrounger and salvage expert, you'll find most of the parts for free, just as the signals are. Descriptions are amazingly complete. You are led through some of the mystery areas of radio such as antennas, grounds, coils, capacitors, earphones, schematic diagrams, and how to plan, layout, and wire your projects. More than just a trip into nostalgia, the book is a lesson in basic radio principles and techniques — and you can dance to the results! 137 pages. ©1977.

HO-RWF

Spiralbound \$5.00

### PRACTICAL ANTENNAS

From the folks at SCELBI, **PRACTICAL ANTENNAS** is not quite like any of the other ham antenna books. Written by a knowledgeable DX'er, this new book is chock-full of helpful hints and suggestions on the how-to's of putting up a super antenna system. Chapters include information on design and construction of practical Yagis, quads and wire type antennas. Inside you'll also find a complete bibliography of antenna articles from the popular amateur publications. Charts and tables are designed to eliminate all those tricky calculations. And, SCELBI has included a list of computer generated beam headings from major population centers to all the countries of the world. A new format, large easy-to-read text and durable vinyl cover make **PRACTICAL ANTENNAS** a "must" for every amateur library. ©1979.

SC-PA

\$9.95

### GUIDE TO RTTY FREQUENCIES

by Oliver P. Ferrell

Radioteletype to many hams and SWL's is an exotic, complicated form of electronic communication. The author is a well known expert in this interesting field and brings to you a wealth of knowledge and practical experience. First he covers the basics of RTTY identification codes and equipment. Once you've mastered the basics, he gives you a complete rundown on how to receive and understand what you'll be seeing. And — there are over 60 pages of worldwide station listings. For your convenience, listings are made by frequency with station location and service. ©1980. 96 pages.

GL-RF

Softbound \$8.95

**Order \$30.00 or more and take a 5% discount. Order will be shipped postpaid.**

**ANTENNA BOOKS by Bill Orr, W6SAI**

**THE RADIO AMATEUR ANTENNA HANDBOOK**

by William I. Orr, W6SAI and Stuart Cowan, W2LX

If you are pondering what new antennas to put up, we recommend you read this very popular book. It contains lots of well illustrated construction projects for vertical, long wire, and HF/VHF beam antennas. But, you'll also get information not usually found in antenna books. There is an honest judgment of antenna gain figures, information on the best and worst antenna locations and heights, a long look at the quad vs. the yagi antenna, information on baluns and how to use them, and some new information on the increasingly popular Sloper and Delta Loop antennas. The text is based on proven data plus practical, on-the-air experience. We don't expect you'll agree with everything Orr and Cowan have to say, but we are convinced that **The Radio Amateur Antenna Handbook** will make a valuable and often consulted addition to any Ham's library. 190 pages. ©1978.

RP-AH **Softbound \$6.95**

**ALL ABOUT CUBICAL QUAD ANTENNAS**

The cubical quad antenna is considered by many to be the best DX antenna because of its simple, lightweight design and high performance. In Bill Orr's latest edition of this well known book, you'll find quad designs for everything from the single element to the multi-element monster quad, plus a new, higher gain expanded quad (X-Q) design. There's a wealth of supplementary data on construction, feeding, tuning, and mounting quad antennas. It's the most comprehensive single edition on the cubical quad available. 112 pages. ©1977.

RP-CQ **Softbound \$4.75**

**SIMPLE LOW-COST WIRE ANTENNAS**

Learn how to build simple, economical wire antennas. Even if you don't know a feedline from a feed-through, W6SAI will get you on the air with an effective low-cost wire antenna. And, apartment dwellers take note! Fool your landlord and your neighbors with some of the "invisible" antennas found here. For the old-timer as well as the beginner, it's a clearly written, well diagrammed, and even humorous antenna book. 192 pages. ©1972.

RP-WA **Softbound \$6.95**

**BEAM ANTENNA HANDBOOK**

Here's recommended reading for anyone thinking about putting up a yagi beam this year. It answers a lot of commonly asked questions like: What is the best element spacing? Can different yagi antennas be stacked without losing performance? Do monoband beams outperform tribanders? Lots of construction projects, diagrams, and photos make reading a pleasurable and informative experience. 198 pages. ©1977.

RP-BA **Softbound \$5.95**

**THE WORKS. ALL FOUR BOOKS  
\$24.60 VALUE — JUST \$21.95**

RP-OL **FOUR BOOKS \$21.95**

**KANTRONICS THEORY CASSETTE**

Here's a new, easy way to study theory for your Novice, General, Advanced or Extra class exam. Designed for folks on the run. All you have to do is drop in the cassette at home, work, or in the car and listen to an interview-style tape covering Novice, General, Advanced or Extra class theory. A great way to reinforce other study methods.

KT-NT Novice Class Theory Cassette **One tape \$4.95**  
 KT-GT General Class Theory Cassette **Two tapes \$8.95**  
 KT-AT Advanced Class Theory Cassette **One tape \$4.95**  
 KT-ET Extra Class Theory Cassette **One tape \$4.95**

**GOING SAILING WITH AMATEUR RADIO**

Are you into sailing? Then you need **Going Sailing** — an extremely helpful book, especially for the boating and yachting enthusiast who wants to incorporate Amateur Radio in his ship's gear. Whether it is just for fun or safety measures, bringing Amateur Radio aboard makes a lot of sense. Next time you're headed for sea, take Amateur Radio and a copy of this great new book for long-range radio communications. 64 pages. ©1978.

HR-GS **Softbound \$3.95**

**SHORTWAVE PROPAGATION HANDBOOK**

Edited by George Jacobs, W3ASK, and Theodore J. Cohen, N4XX

For many hams, both new and old, radio wave propagation is still a mystery. Realizing this, the authors went about the task of preparing a simplified text that could be understood by hams, swl's and engineers alike. Stress has been given to simplified explanations and charts. The authors also detail a simplified method of do-it-yourself propagation forecasting. To assist your forecasting efforts, the book contains a complete listing of the 12 month smoothed sunspot numbers since 1749. Join those who know how to predict when the bands will open to specific areas of the world. ©1979.

CQ-PH **\$7.50**

**ARRL Q & A SERIES**

Each book is full of sample questions that cover just about every aspect of the FCC Amateur exam series. These handy study guides are a must for the soon-to-be or ready-to-upgrade Amateur. Convenient pocket size lets you take your study guide with you everywhere. *Softbound.*

AR-QA Novice ©1979 **\$2.00**  
 AR-TG Technician, General ©1979 **\$2.50**  
 AR-AE Advanced, Extra ©1979 **\$3.00**

**RSGB AMATEUR RADIO OPERATING MANUAL**

Edited by R. J. Eckersley

Compiled by the RSGB, this exciting new book covers just about every facet of Amateur Radio. Starting with a precise description of the Amateur Service worldwide, the **Amateur Radio Operating Manual** leads the Amateur through the steps to setting up a station correctly, how to operate properly, DX, contests, satellites, RTTY and Slow Scan Television. You also get 5 big appendices jam-packed with more information; call signs in use, maps, DXCC country list, time zones and international call sign assignments. 190 pages. ©1979.

RS-OM **Softbound \$9.95**

**GENERAL CLASS AMATEUR LICENSE STUDY GUIDE**

by Phil Anderson, WØXI

This book was written in simple laymen's language with uncomplicated explanations and examples used to present electronic radio concepts and ideas. Throughout each chapter, questions and answers are used to strengthen your understanding of the terms and concepts presented. This book also covers several methods that can be used to improve code reception skills. The final chapter is a sample FCC exam which the author feels he would ask if he were to give the FCC exam. 160 pages. ©1979.

21617 **Softbound \$6.50**

**IN A HURRY?  
ORDER  
TOLL FREE  
1-800-258-5353**

Mail payment and order form to:

Greenville, NH 03048

**Ham Radio's Bookstore**

# Advertisers check-off

... for literature, in a hurry — we'll rush your name to the companies whose names you "check-off"

Place your check mark in the space between name and number. Ex: Ham Radio  234

Ace Comm. _____ 850	Jones _____ 626
AEA _____ 677	KLM _____ 073
AGL _____ 862	Kantronics * _____
Alaska Microwave _____ 826	Kenwood * _____
Aluma _____ 589	L-Tronics _____ 576
Anteck _____ 733	MFJ _____ 082
Astron _____ 734	MHz Elec. _____ 415
Atlantic Surplus * _____	Madison _____ 431
Barker _____ 015	Micro Control _____ 858
Barry * _____	Microcraft _____ 774
Bilal _____ 817	Miller _____ 745
Budwig _____ 233	Nemal * _____
Cal Crystal _____ 709	P. C. Elec. _____ 766
Comm. Concepts _____ 797	Palomar Eng. * _____
Comm. Spec. _____ 330	Pipo _____ 481
DCO _____ 324	Callbook _____ 100
Dave * _____	Constructor * _____
Design Marketing * _____	Radiokit _____ 801
ETCO _____ 856	Radio Warehouse * _____
E. T. O. * _____	Radio World * _____
Elec. Research Virginia * _____	Ramsey _____ 442
Erickson Comm. * _____	Securatron _____ 461
Fair Radio _____ 048	Sherwood _____ 435
Fox-Tango _____ 657	Skytec _____ 704
G & C Comm. _____ 754	Spectronics _____ 191
GLB _____ 552	Spec. Comm. _____ 336
Gem Quad * _____	Spec. Int. _____ 108
Hal _____ 057	Tech. Clinic _____ 845
Hal-Tronix _____ 254	Telrex * _____
H. R. Bookstore _____ 150	Ten-Tec * _____
Horizons * _____	V-J Products _____ 855
H. R. Magazine * _____	Vanguard _____ 716
Heath * _____	Varian _____ 043
Henry _____ 062	VoCom _____ 857
Icom * _____	Webster Assoc. _____ 423
Int. Crystal _____ 066	Western Elec. * _____
Jameco _____ 333	Yaesu _____ 127
Jan _____ 067	

\*Please contact this advertiser directly.

Limit 15 inquiries per request.

**September, 1980**

Please use before October 31, 1980

Tear off and mail to  
HAM RADIO MAGAZINE — "check off"  
Greenville, N. H. 03048

NAME .....

CALL .....

STREET .....

CITY .....

STATE ..... ZIP .....

## LABOR DAZE

ALPHA 76, 374, 78 in Stock . . . . . Call  
Cushcraft "boomer" . . . . . 69.95  
OMNI-J2 Meter Antenna . . . . . 39.95  
Bird 43 and slugs, UPS paid in USA stock  
Microwave Modules, Less 10% off list  
stock  
Telrex TB5EM, in stock . . . . . 425.00  
Telrex TB6EM . . . . . 540.00  
Complete Line Monobanders. . . . . stock  
New Telrex TB5ES, 2KW  
Pep version . . . . . 315.00  
Robot 800 Keyboard . . . . . 699.00  
Bencher Paddles, Standard . . . . . 39.95  
Bencher Paddles, Chrome . . . . . 49.95  
Vibroplex Paddles and bugs. . . . . stock  
Lunar 6M-2M-220 In-line Preamps stock  
Janel QSA-5 . . . . . 41.95  
HAM-X Tailtwister Rotor . . . . . 239.00  
HAM-4 Rotor . . . . . 169.00  
Cetron or GE 572B . . . . . 32.00/ea  
GE, AMPEREX, Raytheon 6146B . . . . . 9.95  
Motorola HEP170 . . . . . 0.29  
Mallory 2.5A/1000 PIV Epoxy diode 0.19  
Sprague 100MFD/450VDC Cap. . . . . 2.00  
Aerovox 1000PF/500V Feedthru Cap 1.95  
Adel Nibbling Tool . . . . . 8.45  
Technical books: Ameco, ARRL, Sams,  
TAB, Rider, Radio Pub., Callbook,  
Cowan, WRTVH, etc. . . . . Call  
New Belden 9405 (2#16) (6#18) 8 wire  
Rotor cable, heavy duty for  
long runs. . . . . 0.38/ft  
8448 8 wire Rotor Cable . . . . . 0.24/ft  
9888 Double Shield RG8 Foam . . . . . 0.56/ft  
8214 RG8 Foam . . . . . 0.32/ft  
8237 RG8 Regular . . . . . 0.28/ft  
8267 RG213 . . . . . 0.36/ft  
9251 RG8 A/U . . . . . 0.42/ft  
Belden #8000 14GA  
Stranded Antenna wire . . . . . 0.10/ft.  
Amphenol Silverplate PL259 (831SP) . . . . . 1.00  
Micro RG-8U 52 OHM, KW . . . . . 0.19/ft.

*Need a schematic &  
We've got 'em — \$2.00*

ICOM IC 2A HANDHELD  
W/TTP, battery pack, Rubber Duck  
and charger \$229.00

*Looking for antique parts?  
Write specific need to W5GJ.*

### THIS MONTH'S SPECIALS:

New IC720, AC — Call  
New ICOM, IC251A — 2M \$599.00  
IC551D — 6M-100W \$599.00  
IC551 \$399.00

Kenwood TS-180S/DFC — SSB  
Call for quote  
Bearcat 250, 220 . . . . . 299.00  
Bearcat 300 . . . . . 399.00

### MASTER CHARGE • VISA

All prices fob Houston except where indicated. Prices subject to change without notice, all items guaranteed. Some items subject prior sale. Texas residents add 6% tax. Please add postage estimate. \$1.00 minimum.

# MADISON

Electronics Supply, Inc.

1508 McKinney • Houston, Texas 77002  
713/658-0268

## Advertisers Index

Ace Communications Inc. . . . .	87
Advanced Electronics Applications . . . . .	91
AGL Electronics . . . . .	23
Alaska Microwave Labs . . . . .	84
Aluma Tower Company . . . . .	71
Anteck, Inc. . . . .	70
Astron Corporation . . . . .	87
Atlantic Surplus Sales . . . . .	86
Barker & Williamson, Inc. . . . .	71
Barry Electronics . . . . .	25
Bilal Company . . . . .	67
Budwig Mfg. Company . . . . .	76
Cal Crystal Lab, Inc. . . . .	96
Communication Concepts, Inc. . . . .	67
Communications Specialists . . . . .	10, 11
DCO, Inc. . . . .	91
Dave . . . . .	76
Design Marketing . . . . .	87
ETCO . . . . .	85
Ehrhorn Technological Operations . . . . .	31
Electronic Research Corp. of Virginia . . . . .	82
Erickson Communications . . . . .	89
Fair Radio Sales . . . . .	67
Fox-Tango Corp. . . . .	95
G & C Communications . . . . .	70
GLB Electronics . . . . .	84
Gem Quad Products . . . . .	86
Hal Communications Corp. . . . .	7
Hal-Tronix . . . . .	91
Ham Radio's Bookstore . . . . .	57, 70, 76, 90, 92, 93
Ham Radio Horizons . . . . .	85
Ham Radio Magazine . . . . .	86
Heath Company . . . . .	72, 73
Henry Radio Stores . . . . .	Cover II
Icom America, Inc. . . . .	5
International Crystal Mfg. Co. . . . .	77
Jameco Electronics . . . . .	63
Jan Crystals . . . . .	87
Jones, Marlin P. & Associates . . . . .	83
Kantronics . . . . .	86
Trio-Kenwood Communications, Inc. . . . .	48, 49
L-Tronics . . . . .	96
MFJ Enterprises . . . . .	2
MHz Electronics . . . . .	78, 79, 80, 81
Madison Electronics Supply . . . . .	1, 94
Microcraft Corporation . . . . .	70, 90
Nemal Electronics . . . . .	70
P. C. Electronics . . . . .	70
Palomar Engineers . . . . .	75
Pipo Communications . . . . .	76, 90
Radio Amateur Callbook . . . . .	84
Radio & Electronics Constructor . . . . .	85
Radiokit . . . . .	86
Radio Warehouse . . . . .	85
Radio World . . . . .	82
Ramsey Electronics . . . . .	96
Securatron . . . . .	86
Sherwood Engineering . . . . .	82
Skytec . . . . .	85
Spectronics . . . . .	36
Spectrum International . . . . .	59
Technical Clinic . . . . .	67
Telrex Laboratories . . . . .	71
Ten-Tec . . . . .	9
V-J Products . . . . .	82
Vanguard Labs . . . . .	82
Varian, Eimac Division . . . . .	Cover IV
VoCom . . . . .	76
Webster Associates . . . . .	95
Western Electronics . . . . .	90
Yaesu Electronics Corp. . . . .	Cover III



# QUALITY CRYSTALS

## In Welded Holders

**Quick delivery...**

**Emergency 48 hour service**

Visa or MasterCard orders welcome!  
Call or write Cal Crystal NOW!



**CAL CRYSTAL**  
California Crystal Lab., Inc.  
1142 North Gilbert Street  
Anaheim, California 92801  
(714) 991-1580



**FOX-TANGO CORP.**

Box 15944H, West Palm Beach, FL 33406

Visa/MC welcomed. Money back if not satisfied.

### 8-POLE FILTER BANDWIDTHS IN STOCK

CRYSTAL FILTER	CW (Hz)						SSB-AM (kHz)				
	125	250	400	500	600	800	1.8	2.1	2.4	6.0	8.0
<b>YAESU</b>	<b>\$55 EACH</b>										
*FT-101/F/FR-101	✓	✓	✓	✓	✓	✓	✓	✓	✓	✓	✓
*FT-301/FT-7B/620	✓	✓	✓	✓	✓	✓	✓	✓	✓	✓	✓
*FT-901/101ZD/107	✓	✓	✓	✓	✓	✓	✓	✓	✓	✓	✓
FT-401/560/570	✓	✓	✓	✓	✓	✓	✓	✓	✓	✓	✓
FT-200/TEMPO I	✓	✓	✓	✓	✓	✓	✓	✓	✓	✓	✓
<b>KENWOOD</b>	<b>\$55 EACH</b>										
*TS-520/R-599	✓	✓	✓	✓	✓	✓	✓	✓	✓	✓	• 2nd IF \$125
*TS-820/R-820	✓	✓	✓	✓	✓	✓	✓	✓	✓	✓	for R-820 only
<b>HEATH</b>	<b>\$55 EACH</b>										
<b>ALL HF</b>	✓	✓	✓	✓	✓	✓	✓	✓	✓	✓	✓
<b>DRAKE</b>	<b>FOR PRICES SEE NOTES</b>										
<b>R-4C</b>	GUF-1 Broad 1st IF Superior Shape Factor/Ult Rej \$65 ✓										
	GUF-2 Narrow 1st IF ✓ + pcb w sw relays \$90										
	2nd IF ✓ Plug in type ✓ \$65										
	GUD Product Detector pcb w relay double balanced type \$30										
<b>COLLINS</b>	<b>SPECIAL \$125 EACH</b>										
75S-3B/C	✓	✓	✓	✓	✓	✓	✓	✓	✓	✓	<b>EQUALS OR EXCELS \$400 COLLINS UNIT</b>

\*DIODE SWITCHING BOARDS available to permit 1, 2 or more filters than those for which manufacturer provides room. SPECIFY make and model.

Single-filter type: \$12 Airmail postpaid

Dual-filter type: \$21 Airmail postpaid

Florida residents add 4% (sales tax) (FOREIGN ADD \$3 per filter)



**BROCHURE ON REQUEST**  
Dealer Inquiries Welcomed



## The Best Got Better



MODEL 4381 RF POWER ANALYST

This new generation RF Wattmeter with nine-mode system versatility reads...

IN STOCK QUICK DELIVERY

AUTHORIZED DISTRIBUTOR

**Webster**

**associates**

115 BELLARMINE  
ROCHESTER, MI 48063

CALL TOLL FREE

**800-521-2333**

IN MICHIGAN 313 - 375-0420

## Repeater Jammers Running You Ragged?

Here's a portable direction finder that REALLY works—on AM, FM, pulsed signals and random noise! Unique left-right DF allows you to take accurate (up to 2°) and fast bearings, even on short bursts. Its 3dB antenna gain and .06 μV typical DF sensitivity allow this crystal-controlled unit to hear and positively track a weak signal at very long ranges—while the built-in RF gain control with 120 dB range permits positive DF to within a few feet of the transmitter. It has no 180° ambiguity and the antenna can be rotated for horizontal polarization.



The DF is battery-powered, can be used with accessory antennas, and is 12/24V for use in vehicles or aircraft. It is available in the 140-150 MHz VHF band and/or 220-230 MHz UHF band. This DF has been successful in locating malicious interference sources, as well as hidden transmitters in "T-hunts", ELTs, and noise sources in RFI situations.

Price for the single band unit is \$195, for the VHF/UHF dual band unit is \$235, plus crystals. Write or call for information and free brochure.

L-TRONICS

5546 Cathedral Oaks Road  
(Attention Ham Dept.)  
Santa Barbara, CA 93111

W6GUX

WD6ESW

**ramsey**

# the first name in Counters!



## 9 DIGITS 600 MHz \$129<sup>95</sup> WIRED

**SPECIFICATIONS:**

Range: 20 Hz to 600 MHz  
 Sensitivity: Less than 10 MV to 150 MHz  
 Less than 50 MV to 500 MHz  
 Resolution: 0.1 Hz (10 MHz range)  
 1.0 Hz (60 MHz range)  
 10.0 Hz (600 MHz range)  
 Display: 9 digits 0.4" LED  
 Time base: Standard-10,000 MHz, 1.0 ppm 20-40°C  
 Optional Micro-power oven-0.1 ppm 20-40°C  
 Power: 8-15 VAC @ 250 ma

**PRICES**  
 CT-90 wired, 1 year warranty \$129.95  
 CT-90 Kit, 90 day parts warranty 109.95  
 AC-1 AC adapter 3.95  
 BP-1 Nicad pack + AC Adapter/Charger 12.95  
 OV-1 Micro-power Oven time base 49.95  
 External time base input 14.95

The CT-90 is the most versatile, feature packed counter available for less than \$300.00! Advanced design features include: three selectable gate times, nine digits, gate indicator and a unique display hold function which holds the displayed count after the input signal is removed! Also, a 10MHz TCXO time base is used which enables easy zero beat calibration checks against WWV. Optionally, an internal nicad battery pack, external time base input and Micro-power high stability crystal oven time base are available. The CT-90, performance you can count on!

## 7 DIGITS 525 MHz \$99<sup>95</sup> WIRED



**SPECIFICATIONS:**

Range: 20 Hz to 525 MHz  
 Sensitivity: Less than 50 MV to 150 MHz  
 Less than 150 MV to 500 MHz  
 Resolution: 1.0 Hz (5 MHz range)  
 10.0 Hz (50 MHz range)  
 100.0 Hz (500 MHz range)  
 Display: 7 digits 0.4" LED  
 Time base: 1.0 ppm TCXO 20-40°C  
 Power: 12 VAC @ 250 ma

The CT-70 breaks the price barrier on lab quality frequency counters. Deluxe features such as: three frequency ranges - each with pre-amplification, dual selectable gate times, and gate activity indication make measurements a snap. The wide frequency range enables you to accurately measure signals from audio thru UHF with 1.0 ppm accuracy - that's .0001%! The CT-70 is the answer to all your measurement needs, in the field, lab or ham shack.

**PRICES:**

CT-70 wired, 1 year warranty \$99.95  
 CT-70 Kit, 90 day parts warranty 84.95  
 AC-1 AC adapter 3.95  
 BP-1 Nicad pack + AC adapter/charger 12.95



## 7 DIGITS 500 MHz \$79<sup>95</sup> WIRED

**PRICES:**

MINI-100 wired, 1 year warranty \$79.95  
 MINI-100 Kit, 90 day part warranty 59.95  
 AC-Z Ac adapter for MINI-100 3.95  
 BP-Z Nicad pack and AC adapter/charger 12.95

Here's a handy, general purpose counter that provides most counter functions at an unbelievable price. The MINI-100 doesn't have the full frequency range or input impedance qualities found in higher price units, but for basic RF signal measurements, it can't be beat! Accurate measurements can be made from 1 MHz all the way up to 500 MHz with excellent sensitivity throughout the range, and the two gate times let you select the resolution desired. Add the nicad pack option and the MINI-100 makes an ideal addition to your tool box for "in-the-field" frequency checks and repairs.

**SPECIFICATIONS:**

Range: 1 MHz to 500 MHz  
 Sensitivity: Less than 25 MV  
 Resolution: 100 Hz (slow gate)  
 1.0 KHz (fast gate)  
 Display: 7 digits, 0.4" LED  
 Time base: 2.0 ppm 20-40°C  
 Power: 5 VDC @ 200 ma

## 8 DIGITS 600 MHz \$159<sup>95</sup> WIRED



**SPECIFICATIONS:**

Range: 20 Hz to 600 MHz  
 Sensitivity: Less than 25 mv to 150 MHz  
 Less than 150 mv to 600 MHz  
 Resolution: 1.0 Hz (60 MHz range)  
 10.0 Hz (600 MHz range)  
 Display: 8 digits 0.4" LED  
 Time base: 2.0 ppm 20-40°C  
 Power: 110 VAC or 12 VDC

The CT-50 is a versatile lab bench counter that will measure up to 600 MHz with 8 digit precision. And, one of its best features is the Receive Frequency Adapter, which turns the CT-50 into a digital readout for any receiver. The adapter is easily programmed for any receiver and a simple connection to the receiver's VFO is all that is required for use. Adding the receiver adapter in no way limits the operation of the CT-50, the adapter can be conveniently switched on or off. The CT-50, a counter that can work double-duty!

**PRICES:**

CT-50 wired, 1 year warranty \$159.95  
 CT-50 Kit, 90 day parts warranty 119.95  
 RA-1, receiver adapter kit 14.95  
 RA-1 wired and pre-programmed (send copy of receiver schematic) 29.95



## DIGITAL MULTIMETER \$99<sup>95</sup> WIRED



**PRICES:**

DM-700 wired, 1 year warranty \$99.95  
 DM-700 Kit, 90 day parts warranty 79.95  
 AC-1, AC adaptor 3.95  
 BP-3, Nicad pack + AC adapter/charger 19.95  
 MP-1, Probe kit 2.95

The DM-700 offers professional quality performance at a hobbyist price. Features include: 26 different ranges and 5 functions, all arranged in a convenient, easy to use format. Measurements are displayed on a large 3 1/2 digit, 1/2 inch LED readout with automatic decimal placement, automatic polarity, overrange indication and overload protection up to 1250 volts on all ranges, making it virtually goof-proof! The DM-700 looks great, a handsome, jet black, rugged ABS case with convenient retractable tilt bail makes it an ideal addition to any shop.

**SPECIFICATIONS:**

DC/AC volts: 100uV to 1 KV, 5 ranges  
 DC/AC current: 0.1uA to 2.0 Amps, 5 ranges  
 Resistance: 0.1 ohms to 20 Megohms, 6 ranges  
 Input impedance: 10 Megohms, DC/AC volts  
 Accuracy: 10.1% basic DC volts  
 Power: 4 °C cells

### AUDIO SCALER

For high resolution audio measurements, multiplies UP in frequency.

- Great for PL tones
- Multiplies by 10 or 100
- 0.01 Hz resolution!

\$29.95 Kit \$39.95 Wired

### ACCESSORIES

Telescopic whip antenna - BNC plug ..... \$ 7.95  
 High impedance probe, light loading ..... 15.95  
 Low pass probe, for audio measurements ..... 15.95  
 Direct probe, general purpose usage ..... 12.95  
 Tilt bail, for CT 70, 90, MINI-100 ..... 3.95  
 Color burst calibration unit, calibrates counter against color TV signal ..... 14.95

### COUNTER PREAMP

For measuring extremely weak signals from 10 to 1,000 MHz. Small size, powered by plug transformer-included.

- Flat 25 db gain
  - BNC Connectors
  - Great for sniffing RF with pick-up loop
- \$34.95 Kit \$44.95 Wired

**ramsey electronics**  
 BOX 4072 • ROCHESTER, NY 14610



PHONE ORDERS  
 CALL 716-586-3950

TERMS

Satisfaction guaranteed - examine for 10 days, if not pleased, return in original form for refund. Add 5% for shipping - insurance to a maximum of \$10. Overseas add 15%. COD add \$2. Orders under \$10, add \$1.50. NY residents add 7% tax.

# Tomorrow's Technology—Here Today!

## THE YAESU FT-207R

The "horse-and-buggy" days of crystal-controlled handies are gone! Yaesu's engineers have harnessed the power of the microprocessor, bringing you 800 channels, digital display, memory, and scanning from a hand-held package. Only with Yaesu can you get these big performance features in such a compact package.

**FALL \$349 SPECIAL!**

includes

**FT-207R**

**NBP-9 BATTERY PACK**

**NC-9B WALL CHARGER**

**AND MINI EARPHONE**

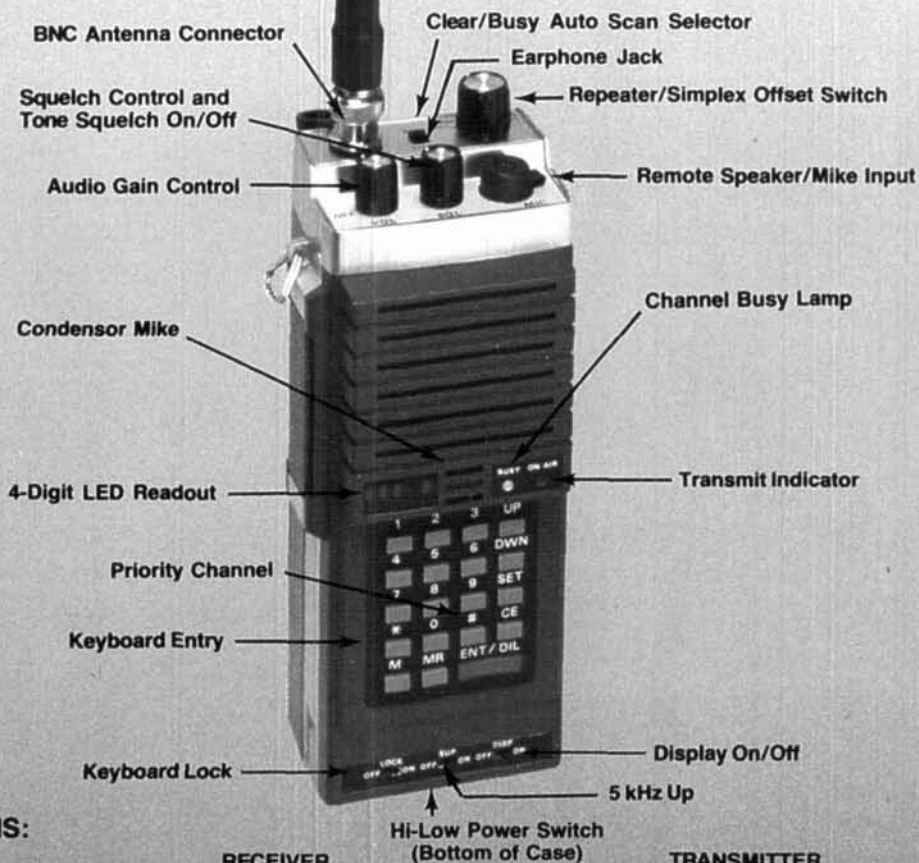

### SPECIFICATIONS:

#### GENERAL

**Frequency coverage:** 144-148 MHz

**Number of channels:** 800

**Emission type:** F3

**Batteries:** NiCd battery pack

**Voltage requirement:** 10.8 VDC  
± 10%, maximum

#### Current consumption:

Receive: 35 mA squelched (150  
mA unsquelched with maximum  
audio)

Transmit: 800 mA (full power)

**Case dimensions:** 68×181×54 mm  
(HWD)

**Weight (with batteries):** 680 grams

#### RECEIVER

**Circuit type:** Double conversion  
superheterodyne  
intermediate frequencies.

1st IF= 10.7 MHz

2nd IF= 455 kHz

**Sensitivity:** 0.32  $\mu$ V for 20 dB quieting

**Selectivity:** ± 7.5 kHz at 60 dB down

**Audio Output:** 200 mW at 10% THD

Price And Specifications Subject To  
Change Without Notice Or Obligation

#### TRANSMITTER

**Power Output:** 2.5 watts minimum /200mW

**Deviation:** ± 5 kHz

**Spurious radiation:** -60 dB or better

**Microphone:** Condenser type  
(2000 ohms)

#### OPTIONS

LC-C7 Leather Carrying Case

YM-24 Remote Speaker/Microphone

Tone Squelch Unit

**YAESU**  
*The radio.*



180

# EIMAC's new high-mu triode/cavity combination. It takes the hassle out of 10 kW VHF transmitter design.

Relax. Now EIMAC offers you the best triode available and a cavity that has been custom designed for it. All you have to do is design them in.

The advantages are impressive. EIMAC's ceramic-metal high-mu triode (3CX10000U7) gives you peak sync power output of 10 kW and a stage gain of 14 dB. That's 2 dB more than with comparable tetrodes.

And there's more. Driving requirements are reduced; screen power supply and screen circuitry are eliminated; and cooling requirements are lessened. The result is ease of maintenance and substantial cost reduction.

There are two EIMAC cavities for your 10 kW combination, the CV-2240 for channels 2-6, and the CV-2250 for channels 7-13. For further information contact Varian, EIMAC Division, 301 Industrial Way, San Carlos, California 94070, (415) 592-1221. Or call any of the more than 30 Varian Electron Device Group Sales Offices throughout the world.



varian